

ASUS[®] P2L97-S
Pentium[®] II Motherboard

USER'S MANUAL

USER'S NOTICE

No part of this manual, including the products and software described in it, may be reproduced, transmitted, transcribed, stored in a retrieval system, or translated into any language in any form or by any means, except documentation kept by the purchaser for backup purposes, without the express written permission of ASUSTeK COMPUTER INC. ("ASUS").

ASUS PROVIDES THIS MANUAL "AS IS" WITHOUT WARRANTY OF ANY KIND, EITHER EXPRESS OR IMPLIED, INCLUDING BUT NOT LIMITED TO THE IMPLIED WARRANTIES OR CONDITIONS OF MERCHANTABILITY OR FITNESS FOR A PARTICULAR PURPOSE. IN NO EVENT SHALL ASUS, ITS DIRECTORS, OFFICERS, EMPLOYEES OR AGENTS BE LIABLE FOR ANY INDIRECT, SPECIAL, INCIDENTAL, OR CONSEQUENTIAL DAMAGES (INCLUDING DAMAGES FOR LOSS OF PROFITS, LOSS OF BUSINESS, LOSS OF USE OR DATA, INTERRUPTION OF BUSINESS AND THE LIKE), EVEN IF ASUS HAS BEEN ADVISED OF THE POSSIBILITY OF SUCH DAMAGES ARISING FROM ANY DEFECT OR ERROR IN THIS MANUAL OR PRODUCT.

Product warranty or service will not be extended if: (1) the product is repaired, modified or altered, unless such repair, modification or alteration is authorized in writing by ASUS; or (2) the serial number of the product is defaced or missing.

Products and corporate names appearing in this manual may or may not be registered trademarks or copyrights of their respective companies, and are used only for identification or explanation and to the owners' benefit, without intent to infringe.

- Intel, LANDesk, and Pentium are registered trademarks of Intel Corporation.
- IBM and OS/2 are registered trademarks of International Business Machines.
- Symbios is a registered trademark of Symbios Logic Corporation.
- Windows and MS-DOS are registered trademarks of Microsoft Corporation.
- Sound Blaster AWE32 and SB16 are trademarks of Creative Technology Ltd.
- Adobe and Acrobat are registered trademarks of Adobe Systems Incorporated.

The product name and revision number are both printed on the product itself. Manual revisions are released for each product design represented by the digit before and after the period of the manual revision number. Manual updates are represented by the third digit in the manual revision number.

For previous or updated manuals, BIOS, drivers, or product release information, contact ASUS at <http://www.asus.com.tw> or through any of the means indicated on the following page.

SPECIFICATIONS AND INFORMATION CONTAINED IN THIS MANUAL ARE FURNISHED FOR INFORMATIONAL USE ONLY, AND ARE SUBJECT TO CHANGE AT ANY TIME WITHOUT NOTICE, AND SHOULD NOT BE CONSTRUED AS A COMMITMENT BY ASUS. ASUS ASSUMES NO RESPONSIBILITY OR LIABILITY FOR ANY ERRORS OR INACCURACIES THAT MAY APPEAR IN THIS MANUAL, INCLUDING THE PRODUCTS AND SOFTWARE DESCRIBED IN IT.

Copyright © 1998 ASUSTeK COMPUTER INC. All Rights Reserved.

| | |
|------------------|---------------------|
| Product Name: | ASUS P2L97-S |
| Manual Revision: | 2.01 |
| Release Date: | April 1998 |

ASUS CONTACT INFORMATION

ASUSTeK COMPUTER INC.

Marketing

Address: 150 Li-Te Road, Peitou, Taipei, Taiwan 112
Telephone: +886-2-2894-3447
Fax: +886-2-2894-3449
Email: info@asus.com.tw

Technical Support

Fax: +886-2-2895-9254
BBS: +886-2-2896-4667
Email: tsd@asus.com.tw
WWW: www.asus.com.tw
FTP: ftp.asus.com.tw/pub/ASUS

ASUS COMPUTER INTERNATIONAL

Marketing

Address: 6737 Mowry Ave, Mowry Business Center, Building 2,
Newark, CA 94560, USA
Fax: +1-510-608-4555
Email: info-usa@asus.com.tw

Technical Support

Fax: +1-510-608-4555
BBS: +1-510-739-3774
Email: tsd-usa@asus.com.tw
WWW: www.asus.com
FTP: ftp.asus.com.tw/pub/ASUS

ASUS COMPUTER GmbH

Marketing

Address: Harkort Str. 25, 40880 Ratingen, BRD, Germany
Telephone: 49-2102-445011
Fax: 49-2102-442066
Email: info-ger@asus.com.tw

Technical Support

Hotline: 49-2102-499712
BBS: 49-2102-448690
Email: tsd-ger@asus.com.tw
WWW: www.asuscom.de
FTP: ftp.asuscom.de/pub/ASUSCOM

CONTENTS

| | |
|---|-----------|
| I. INTRODUCTION | 7 |
| How this Manual is Organized | 7 |
| Item Checklist | 7 |
| II. FEATURES | 8 |
| Features of the ASUS P2L97-S Motherboard | 8 |
| The ASUS P2L97-S Motherboard | 9 |
| III. INSTALLATION | 10 |
| Layout of the ASUS P2L97-S Motherboard | 10 |
| Installation Steps | 12 |
| 1. Jumpers | 12 |
| Jumper Settings | 13 |
| 2. System Memory (DIMM) | 17 |
| DIMM Memory Installation Procedures: | 18 |
| 3. Central Processing Unit (CPU) | 19 |
| Pentium II Processor | 19 |
| AAVID Heatsink | 23 |
| Elan Vital Heatsink | 23 |
| 4. Expansion Cards | 24 |
| Expansion Card Installation Procedure | 24 |
| Assigning IRQs for Expansion Cards | 24 |
| Assigning DMA Channels for ISA Cards | 25 |
| ISA Cards and Hardware Monitor | 25 |
| Accelerated Graphics Port | 25 |
| 5. External Connectors | 26 |
| Power Connection Procedures | 33 |
| IV. BIOS SOFTWARE | 34 |
| Support Software | 34 |
| Flash Memory Writer Utility | 34 |
| Main Menu | 35 |
| Advanced Features Menu | 35 |
| Managing & Updating your Motherboard's BIOS | 36 |
| 6. BIOS Setup | 37 |
| Load Defaults | 38 |
| Standard CMOS Setup | 38 |
| Details of Standard CMOS Setup: | 38 |
| BIOS Features Setup | 41 |
| Details of BIOS Features Setup | 41 |

CONTENTS

| | |
|---|-----------|
| Chipset Features Setup | 44 |
| Details of Chipset Features Setup | 44 |
| Power Management Setup | 47 |
| Details of Power Management Setup | 47 |
| PNP and PCI Setup | 50 |
| Details of PNP and PCI Setup | 50 |
| Load BIOS Defaults | 52 |
| Load Setup Defaults | 52 |
| Supervisor Password and User Password | 53 |
| IDE HDD Auto Detection | 54 |
| Save & Exit Setup | 55 |
| Exit Without Saving | 55 |
| V. DESKTOP MANAGEMENT | 56 |
| Desktop Management Interface (DMI) | 56 |
| Introducing the ASUS DMI Configuration Utility | 56 |
| System Requirements | 56 |
| Using the ASUS DMI Configuration Utility | 57 |
| VI. ADAPTEC SCSI SELECT | 59 |
| Configuring the SCSI Adapter | 59 |
| Configure/View Host Adapter Settings | 59 |
| SCSI Disk Utilities | 59 |
| VII. ADAPTEC EZ-SCSI UTILITY | 61 |
| Quick Start Instructions | 61 |
| Windows95 or WindowsNT | 61 |
| Windows/Windows for Workgroups 3.1x | 61 |
| DOS | 61 |
| Troubleshooting Tips | 62 |
| SCSI Device Troubleshooting | 62 |
| Windows95/WindowsNT Troubleshooting | 62 |
| Information for DOS/Windows 3.1x Users | 65 |
| DOS and Windows3.1x Device Drivers | 65 |
| DOS and Windows3.1x ASPI Managers | 65 |
| DOS Formatting Utilities | 66 |
| Low-level Formatter (scsifmt) | 66 |
| Formatter and Partitioner (afdisk) | 67 |
| VIII. ADAPTEC 7800 FAMILY MANAGER SET (84 pages) | |
| (Drivers for onboard Adaptec 7880 SCSI Chipset) | |

FCC & DOC COMPLIANCE

Federal Communications Commission Statement

This device complies with FCC Rules Part 15. Operation is subject to the following two conditions:

- This device may not cause harmful interference, and
- This device must accept any interference received, including interference that may cause undesired operation.

This equipment has been tested and found to comply with the limits for a Class B digital device, pursuant to Part 15 of the FCC Rules. These limits are designed to provide reasonable protection against harmful interference in a residential installation. This equipment generates, uses and can radiate radio frequency energy and, if not installed and used in accordance with manufacturer's instructions, may cause harmful interference to radio communications. However, there is no guarantee that interference will not occur in a particular installation. If this equipment does cause harmful interference to radio or television reception, which can be determined by turning the equipment off and on, the user is encouraged to try to correct the interference by one or more of the following measures:

- Re-orient or relocate the receiving antenna.
- Increase the separation between the equipment and receiver.
- Connect the equipment to an outlet on a circuit different from that to which the receiver is connected.
- Consult the dealer or an experienced radio/TV technician for help.

WARNING! The use of shielded cables for connection of the monitor to the graphics card is required to assure compliance with FCC regulations. Changes or modifications to this unit not expressly approved by the party responsible for compliance could void the user's authority to operate this equipment.

Canadian Department of Communications Statement

This digital apparatus does not exceed the Class B limits for radio noise emissions from digital apparatus set out in the Radio Interference Regulations of the Canadian Department of Communications.

I. INTRODUCTION

How this Manual is Organized

This manual is divided into the following sections:

| | |
|--------------------------------|--|
| I. Introduction | Manual information and checklist |
| II. Features | Information and specifications |
| III. Installation | Instructions on setting up the motherboard. |
| IV. BIOS Software | Instructions on setting up the BIOS software |
| V. DMI Utility | BIOS supported Desktop Management Interface |
| VI. Adaptec SCSI Select | Adaptec SCSI Select utility |
| VII. Adaptec EZ-SCSI | Adaptec EZ-SCSI utility |
| VIII. Adaptec 7800 | Adaptec SCSI driver installation and usage |

Item Checklist

Check that your package is complete. If you discover damaged or missing items, contact your retailer.

- ASUS P2L97-S motherboard
- Retention mechanism & heatsink support
- 1 IDE ribbon cable
- 1 floppy ribbon cable
- 50-pin Fast SCSI cable
- ASUS P2L97-S Support Drivers & Utilities
 - Flash Memory Writer utility to update the FLASH BIOS
 - Desktop Management Interface (DMI) utility
 - LANDesk® Client Manager (LDCM) Software (with optional onboard LM78)
 - Adaptec SCSI drivers and utilities
 - Readme files for descriptions and use of the files
 - Technical Support Form
- This user's manual
- Infrared module (optional)
- 68-Pin Fast&Wide-SCSI cable (optional)

II. FEATURES

Features of the ASUS P2L97-S Motherboard

The ASUS P2L97-S is carefully designed for the demanding PC user who wants many features processed by the fastest CPU. This motherboard:

- **Versatile Processor Support:** Intel Pentium® II (233MHz–333MHz) processor.
- **Intel Chipset:** Features Intel's 440LX AGPset with I/O subsystems.
- **Adaptec SCSI Chipset:** Features Adaptec's 7880 Ultra-Fast/Wide SCSI chipset.
- **Easy Installation:** Equipped with BIOS that supports auto detection of hard drives, PS/2 mouse, and Plug and Play devices to make setup of hard drives, expansion cards, and other devices virtually automatic.
- **ISA & PCI Expansion Slots:** Provides one 16-bit ISA, three 32-bit PCI slots, and one ISA/PCI shared slot.
- **Super Multi-I/O:** Provides two high-speed UART compatible serial ports and one parallel port with EPP and ECP capabilities. UART2 can also be directed from COM2 to the Infrared Module for wireless connections.
- **Desktop Management Interface (DMI):** Supports DMI through BIOS, which allows hardware to communicate within a standard protocol creating a higher level of compatibility. (Requires DMI-enabled components.) (See section V)
- **PCI Bus Master IDE Controller:** Comes with an onboard PCI Bus Master IDE controller with two connectors that supports four IDE devices in two channels, supports PIO Modes 3 and 4 and Bus Master IDE DMA Mode 2, and supports Enhanced IDE devices, such as Tape Backup and CD-ROM drives. Two floppy drives of either 5.25inch or 3.5inch (1.44MB or 2.88MB) are also supported without an external card. Supports Japanese standard "Floppy 3 mode" (3.5-inch disk drive: 1.2MB) and LS-120 floppy disk drives (3.5-inch disk drive: 120 MB, 1.44MB, 720K). BIOS supports IDE CD-ROM or SCSI device boot-up.
- **Multi-Cache:** Supports a Pentium® II processor with either 512KB, 256KB, or 0KB Pipelined Burst Level 2 cache in the Single Edge Contact (SEC) cartridge.
- **Versatile Memory Support:** Equipped with three DIMM sockets to support (8, 16, 32, 64, or 128MB) 168-pin SDRAM/EDO memory modules up to 384MB.
- **IrDA:** Supports an optional infrared port module for wireless interface.
- **Concurrent PCI:** Concurrent PCI allows multiple PCI transfers from PCI master busses to memory to CPU.
- **AGP:** Supports Accelerated Graphics Port cards for high performance, component level interconnect targeted at 3D graphical display applications.
- **Intelligence:** Supports Fan Status Monitoring and Alarm, Temperature Monitoring and Alert, Voltage Monitoring and Alert, System Resources Alert, and Virus Write Protection through the optional onboard LM78 Hardware Monitor and Intel® LANdesk Client Manager (LDCM) software.

II. FEATURES

The ASUS P2L97-S Motherboard

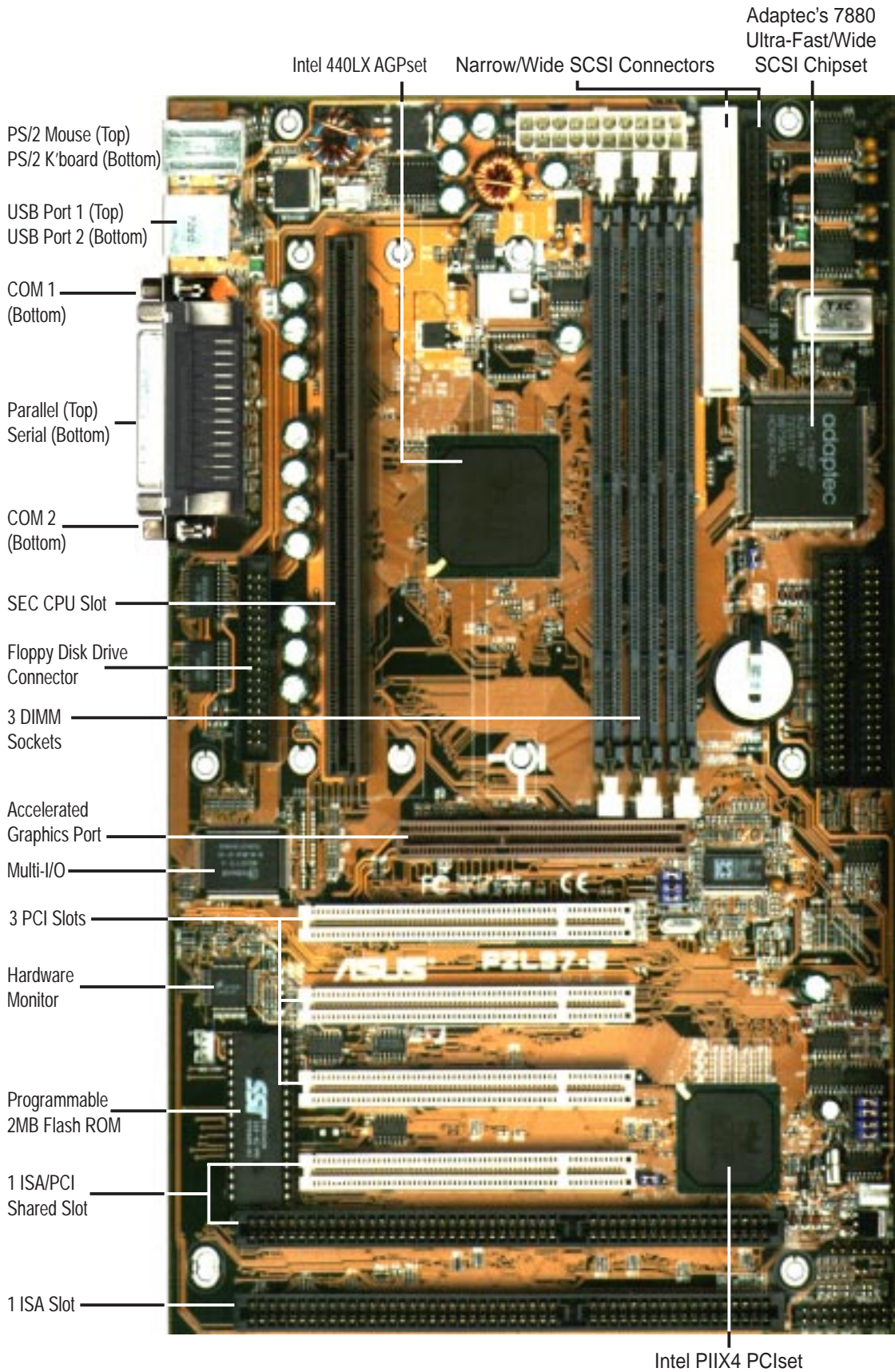

II. FEATURES
(Motherboard Parts)

III. INSTALLATION

Layout of the ASUS P2L97-S Motherboard

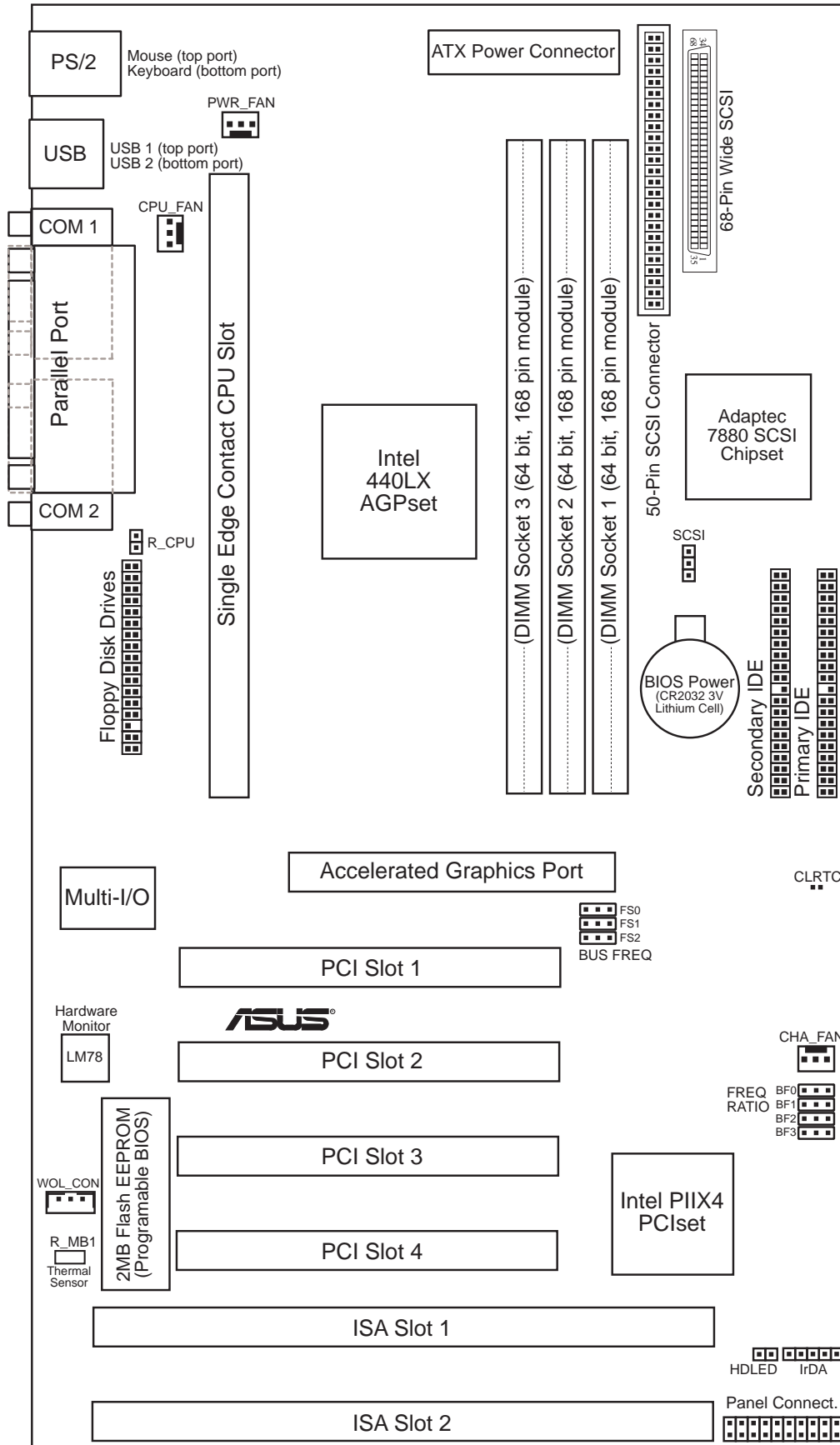

III. INSTALLATION
 (Board Layout)

III. INSTALLATION

Jumpers

- | | |
|-----------------------|---------------------------------------|
| 1) SCSI | p. 13 Onboard SCSI Setting |
| 2) FS0, FS1, FS2 | p. 14 CPU Bus Frequency |
| 3) BF0, BF1, BF2, BF3 | p. 14 CPU Core:Bus Frequency Multiple |
| 4) CLRTC | p. 15 Clear Real Time Clock (RTC) RAM |

Expansion Slots/Sockets

- | | |
|---------------------------|---------------------------------------|
| 1) System Memory | p. 17 System Memory Support |
| 2) DIMM Sockets | p. 18 DIMM Memory Module Support |
| 3) SEC CPU Slot | p. 19 Single Edge Contact CPU Support |
| 4) SLOT1, SLOT2 | p. 24 16-bit ISA Bus Expansion Slots* |
| 5) PCI1, PCI2, PCI3, PCI4 | p. 25 32-bit PCI Bus Expansion Slots† |
| 6) AGP | p. 25 Accelerated Graphics Port |

Hardware Monitor

- | | |
|----------|---|
| 1) R_CPU | p. 22 Pentium II Processor Thermal Sensor Connector |
|----------|---|

Connectors

- | | |
|-------------------------|---|
| 1) PS2KEYBOARD | p. 26 PS/2 Keyboard Connector (6-pin female) |
| 2) PS2MOUSE | p. 26 PS/2 Mouse Connector (6-pin female) |
| 3) PRINTER | p. 27 Parallel (Printer) Port Connector (25-pin female) |
| 4) COM1, COM2 | p. 27 Serial Port COM1 & COM2 (two 9-pin male) |
| 5) FLOPPY | p. 27 Floppy Drive Connector (34-1 pin block) |
| 6) USB | p. 28 Universal Serial BUS Ports 1 & 2 (two 4-pin female) |
| 7) Primary / Second IDE | p. 28 Primary / Secondary IDE Connector (40-pin blocks) |
| 8) HDLED | p. 29 IDE LED Activity Light (2 pins) |
| 9) CHA_, CPU_, PWR_FAN | p. 29 Chassis, CPU, Power Supply Fan Connectors (3-pin block) |
| 10) IR | p. 30 Infrared Port Module Connector (5 pins) |
| 11) ATXPWR | p. 30 ATX Motherboard Power Connector (20-pin block) |
| 12) WOL | p. 31 Wake on LAN (3 pins) (Reserved) |
| 13) NARROW/WIDE SCSI | p. 31 50-pin Fast SCSI II & 68-pin Fast&Wide SCSI III |
| 14) TB_LED (PANEL) | p. 32 LED Lead (2 pins) |
| 15) SMI (PANEL) | p. 32 SMI Switch Switch Lead (2 pins) |
| 16) PWR_SW (PANEL) | p. 32 ATX Power Switch / Soft Power Switch (2 pins) |
| 17) RESET (PANEL) | p. 32 Reset Switch Lead (2 pins) |
| 18) KEYLOCK (PANEL) | p. 32 System Power LED (3 pins) |
| 19) KEYLOCK (PANEL) | p. 32 Keyboard Lock Switch Lead (2 pins) |
| 20) SPEAKER (PANEL) | p. 32 Speaker Connector (4 pins) |

*The onboard hardware monitor uses the address 290H-297H so legacy ISA cards must not use this address or else conflicts will occur.

†PCI slots 4 share the same interrupt number (INT#) as the onboard SCSI so PCI slot 4 card must be able to share an INT# or make sure that it does not use an INT# at all.







III. INSTALLATION

Installation Steps

Before using your computer, you must complete the following steps:

1. **Set Jumpers**
2. **Install Memory Modules**
3. **Install the Central Processing Unit (CPU)**
4. **Install Expansion Cards**
5. **Connect Ribbon Cables, Cabinet Wires, and Power Supply**
6. **Setup the BIOS Software**

1. Jumpers

Several hardware settings are made through the use of jumper caps to connect jumper pins (JP) on the motherboard. See motherboard layout on page 10 for locations of jumpers. The jumper settings will be described numerically such as [----], [1-2], [2-3] for no connection, connect pins 1&2, and connect pins 2&3 respectively. Pin 1 for our motherboards is always on top  or on the left  when holding the motherboard with the keyboard connector away from yourself. A “1” is written besides pin 1 on jumpers with three pins. The jumpers will also be shown graphically such as  to connect pins 1&2 and  to connect pins 2&3. Jumpers with two pins will be shown as  for Short (On) and  for Open (Off). For manufacturing simplicity, the jumpers may be sharing pins from other groups. Use the diagrams in this manual instead of following the pin layout on the board. Settings with two jumper numbers require that both jumpers be moved together. To connect the pins, simply place a plastic jumper cap over the two pins as diagramed.

WARNING! Computer motherboards and expansion cards contain very delicate Integrated Circuit (IC) chips. To protect them against damage from static electricity, you should follow some precautions whenever you work on your computer.

1. Unplug your computer when working on the inside.
2. Use a grounded wrist strap before handling computer components. If you do not have one, touch both of your hands to a safely grounded object or to a metal object, such as the power supply case.
3. Hold components by the edges and try not to touch the IC chips, leads or connectors, or other components.
4. Place components on a grounded antistatic pad or on the bag that came with the component whenever the components are separated from the system.

III. INSTALLATION

Jumper Settings

1. Onboard SCSI Setting (SCSI)

This motherboard gives you the option of using the onboard Adaptec 7880 SCSI BIOS through either the **PnP and PCI Setup** of the BIOS SOFTWARE or the use of jumper caps.

| <u>Selection</u> | <u>SCSI</u> |
|------------------|-------------|
| Enable | [1-2] |
| Disable | [2-3] |

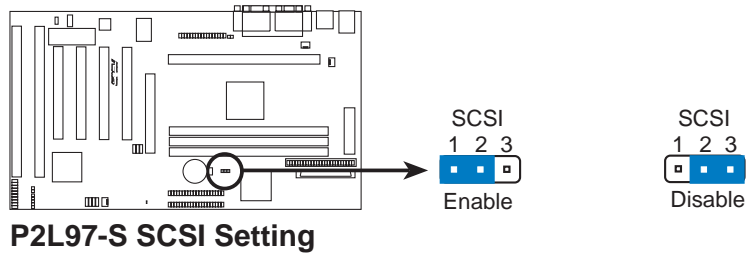

III. INSTALLATION

2. CPU Bus Frequency (FS0, FS1, FS2)

This option tells the clock generator what frequency to send to the CPU. This allows the selection of the CPU's *External* frequency (or *BUS Clock*). The BUS Clock multiplied by the BUS Ratio equals the CPU's *Internal* frequency (the advertised CPU speed).

3. CPU Core:BUS Frequency Multiple (BF0, BF1, BF2, BF3)

This option sets the frequency ratio between the *Internal* frequency of the CPU and the CPU's *External* frequency. These must be set in conjunction with the *CPU Bus Frequency*.

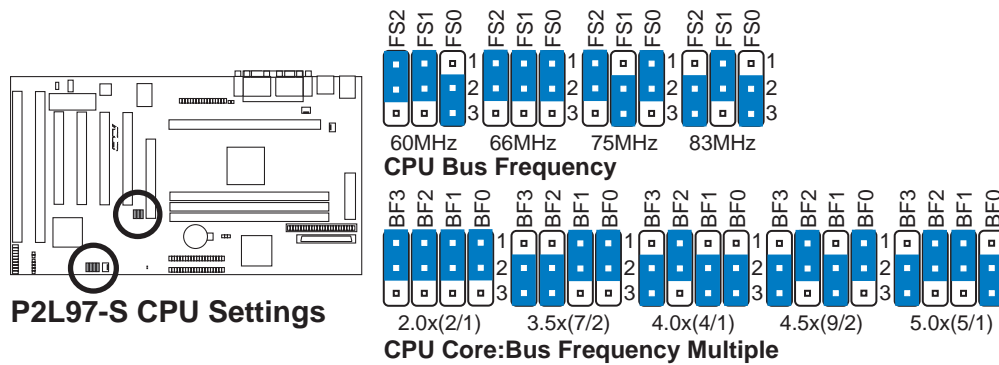

WARNING! Frequencies above 66MHz exceed the specifications for the onboard Intel Chipset and are not guaranteed to be stable.



Intel Pentium II Processor in a SEC Cartridge
(233-333MHz 512KB/256KB/0KB L2 Cache)

Set the jumpers by the Internal speed of your processor as follows:

| CPU Model | Freq. | Ratio | (BUS Freq.) | | | (Freq. Ratio) | | | | |
|------------------|--------|-------|-------------|-------|-------|---------------|-------|-------|-------|-------|
| | | | BUS F. | FS2 | FS1 | FS0 | BF3 | BF2 | BF1 | BF0 |
| Intel Pentium II | 333MHz | 5.0x | 66MHz | [1-2] | [1-2] | [1-2] | [2-3] | [1-2] | [1-2] | [2-3] |
| Intel Pentium II | 300MHz | 4.5x | 66MHz | [1-2] | [1-2] | [1-2] | [2-3] | [1-2] | [2-3] | [1-2] |
| Intel Pentium II | 266MHz | 4.0x | 66MHz | [1-2] | [1-2] | [1-2] | [2-3] | [1-2] | [2-3] | [2-3] |
| Intel Pentium II | 233MHz | 3.5x | 66MHz | [1-2] | [1-2] | [1-2] | [2-3] | [2-3] | [1-2] | [1-2] |

IMPORTANT: Do not set the Frequency Ratio (BF) jumpers to all [2-3], this will cause unexpected behaviors.

NOTES: Overclocking your processor is not recommended. It may result in a slower speed. Voltage Regulator Output Selection (VID) is not needed for the Pentium II processor because it sends a VID signal directly to the onboard power controller.

III. INSTALLATION
(Jumpers)

III. INSTALLATION

4. Real Time Clock (RTC) RAM (CLRRTC)

The CMOS RAM is powered by the onboard button cell battery. To clear the RTC data: (1) Turn off your computer and unplug its AC power, (2) Short the two solder points labeled CLRRTC, (3) Turn on your computer, (4) Hold down <Delete> during bootup and enter BIOS setup to re-enter user preferences.

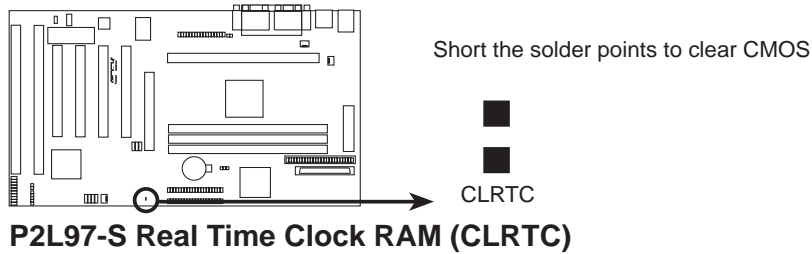

(This page was intentionally left blank)

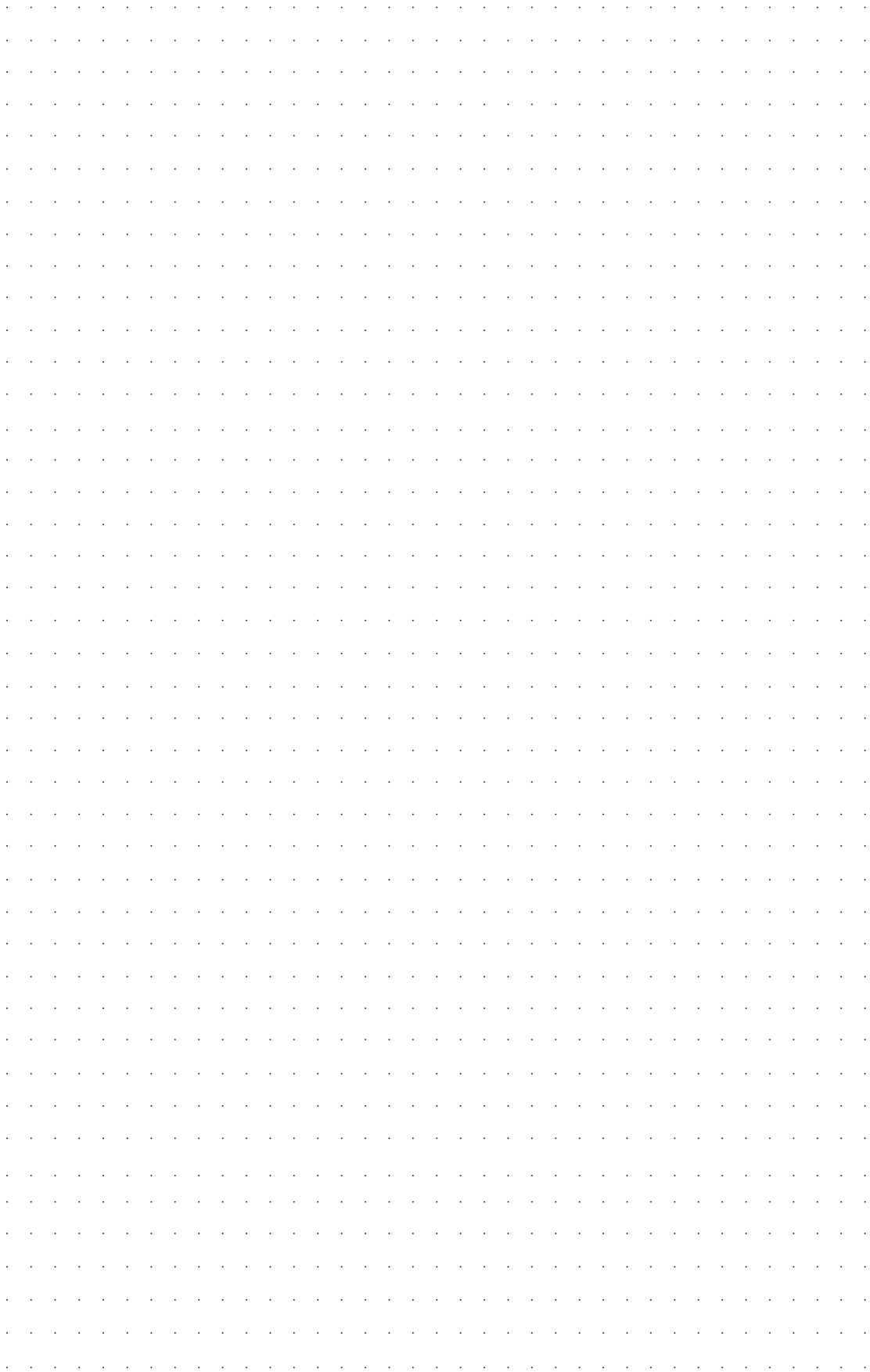

III. INSTALLATION

2. System Memory (DIMM)

Only Dual Inline Memory Modules (DIMM's) can be used with this motherboard. Two sockets are available for **3.3Volt** (power level) Unbuffered Synchronous DRAMs (SDRAM) or EDO DRAM of either 8, 16, 32, 64, or 128MB to form a memory size between 8MB to 384MB. One side (with memory chips) of the DIMM module takes up one Row on the motherboard.

To utilize the chipset's Error Checking and Correction (ECC) feature, you must use a DIMM module with 9 chips per side (standard 8 chips/side + 1 parity chip) and make the proper settings in the BIOS Chipset Features Setup.

IMPORTANT: Memory speed setup is required through "Auto Configuration" in BIOS Chipset Features Setup.

Install memory in any combination as follows:

| DIMM Location | 168-pin DIMM Memory Modules | | Total Memory |
|---------------------|--|----|--------------|
| Socket 1 (Rows 0&1) | SDRAM/EDO 8, 16, 32, 64, 128MB | x1 | |
| Socket 2 (Rows 2&3) | SDRAM/EDO 8, 16, 32, 64, 128MB | x1 | |
| Socket 3 (Rows 4&5) | SDRAM/EDO 8, 16, 32, 64, 128MB | x1 | |
| | Total System Memory (Max 384MB) | = | |

III. INSTALLATION
(System Memory)

ASUS Memory Examples:



Parity EDO DIMM (9 chips)

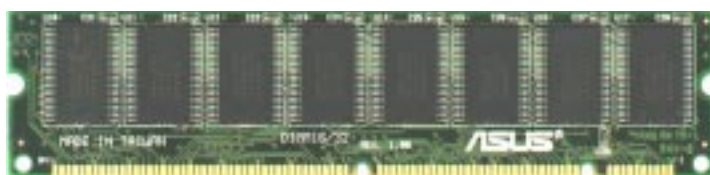

Non-Parity SDRAM DIMM (8 chips)

General DIMM Notes: (not true for all memory modules)

- Four possible memory chips are supported: EDO or SDRAM with and without parity.
- SDRAM chips are generally thinner with higher pin density than EDO chips.
- BIOS shows EDO or SDRAM memory on bootup screen.
- 8 chip/side modules do not support parity, only 9 chip/side modules support parity.
- Single sided modules are usually 16 or 64 MB, double sided are usually 8, 32, or 128MB.

III. INSTALLATION

DIMM Memory Installation Procedures:

Insert the module(s) as shown. Because the number of pins are different on either side of the breaks, the module will only fit in the orientation as shown. DRAM SIMM modules have the same pin contact on both sides. SDRAM DIMM modules have a different pin contact on each side and therefore have a higher pin density.

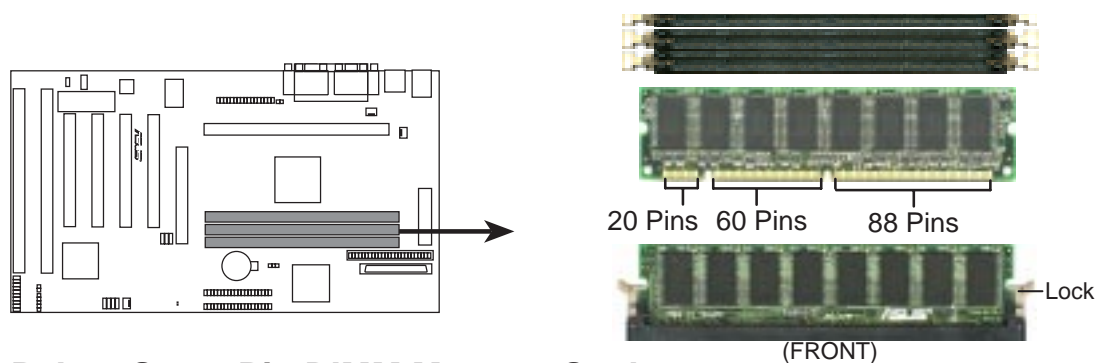

P2L97-S 168-Pin DIMM Memory Sockets

The Dual Inline Memory Module (DIMM) memory modules must be 3.3Volt Unbuffered Synchronous DRAM (SDRAM) or Extended Data Output (EDO) . You can identify the type of DIMM module by the illustration below:

168-Pin DIMM Notch Key Definitions (3.3V)

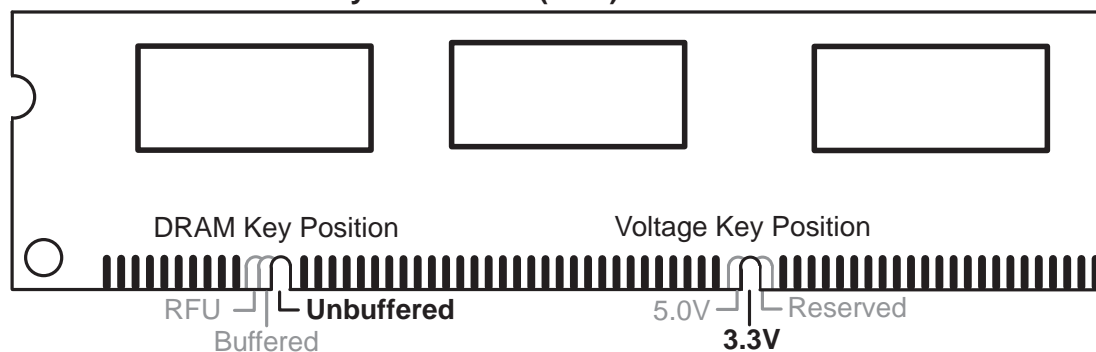

The notch on the DIMM module will shift between left, center, or right to identify the type and also to prevent the wrong type to be inserted into the DIMM slot on the motherboard. You must ask your retailer for the specifications before purchasing. Four clock signals are supported on this motherboard.

III. INSTALLATION

3. Central Processing Unit (CPU)

The ASUS P2L97-S motherboard provides a Single Edge Contact (SEC) slot for a Pentium II processor packaged in an SEC cartridge.

Pentium II Processor

WARNING! Be sure that sufficient air circulation is available across the processor's passive heatsink. Without sufficient circulation, the processor could overheat and damage both the processor and the motherboard. You may install an auxiliary fan, if necessary.

You should check to see that you have the following 9 items.

NOTE: The pictures in the following pages will have the same item numbers next to them for your reference. The design and color of your items may be slightly different.

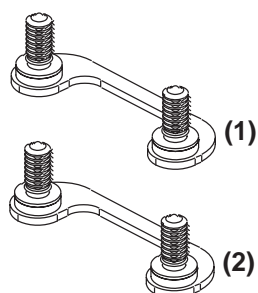

Attach Mount Bridges (Items 1,2)

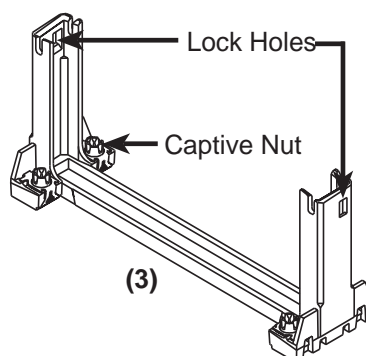

Pentium II Retention Mechanism (Item 3)

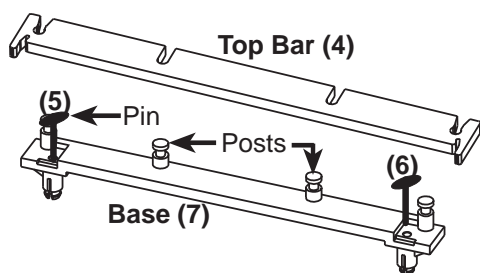

Heatsink Support Base/Top Bar (Items 4-7)

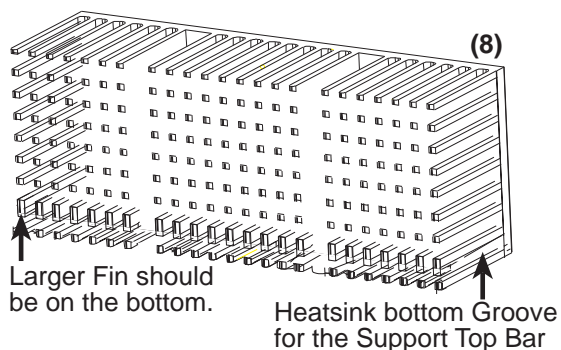

Pentium II Processor Heatsink (Item 8)



Intel Pentium II Processor in a SEC Cartridge (233-333MHz 512KB/256KB/0KB L2 Cache)

CPU (Item 9)

III. INSTALLATION

The ASUS P2L97-S As Shipped

Four screws should be showing next to each corner of the SEC CPU Slot using two attach mount bridges from the underside of the motherboard. A bottom heatsink support base must be mounted over the two chipsets located to the side of the slot.



SEC CPU slot

NOTE: Encircled items are screws from the mount bridges (1 & 2)

Installing the Pentium II Processor

1. Mount the Pentium II Retention Mechanism: The retention mechanism is designed to fit into the SEC slot only one way.

TIP: Orient the mechanism's lock holes toward the motherboard's chipset (see motherboard layout for the location of the Intel 440LX AGPset).

Be sure to align the notch in the mechanism with the small rib on one side of the slot and that the mechanism is properly seated on the board. Then, screw the captive nuts in place.

WARNING! Do not overtighten the captive nuts. Doing so could damage your motherboard. Tighten captive nuts to no more than 6±1 inch/pound.

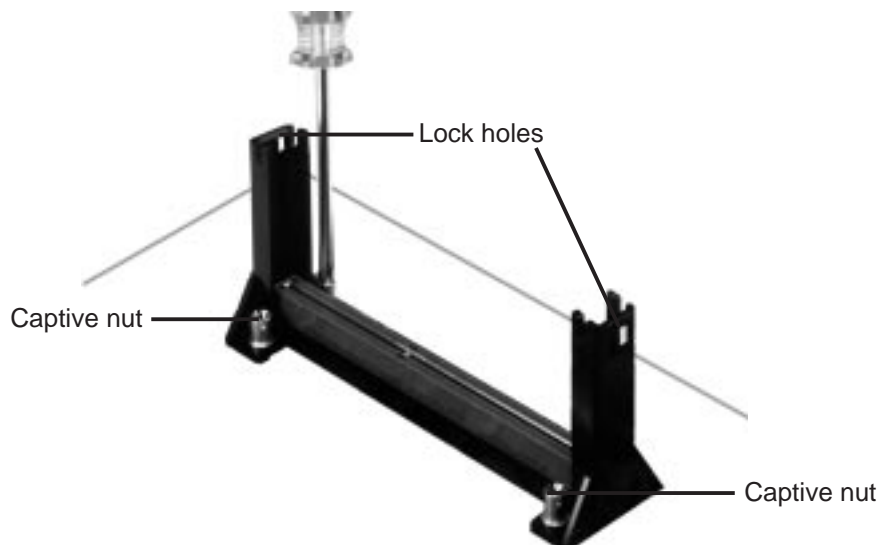

III. INSTALLATION

- 2. Mount the Heatsink:** Place the SEC cartridge face down on a flat surface and lay the heat sink flush on the back (metal side) of the SEC cartridge. Check the orientation of the heatsink against the pictures. The thicker fin must be orientated toward the bottom. The top clamp is wider than the bottom clamp so only this orientation will fit. With a screw driver, push the clamps one at a time into the SEC cartridge. Be sure that the heatsink is firmly pressed against the SEC cartridge. When correctly installed, no light must be showing through between the thermal pad of the heatsink and the SEC cartridge.

WARNING! If the heatsink is not mounted tightly against the SEC cartridge, the CPU will overheat. You may install an auxiliary fan to provide adequate circulation across the processor's passive heatsink.

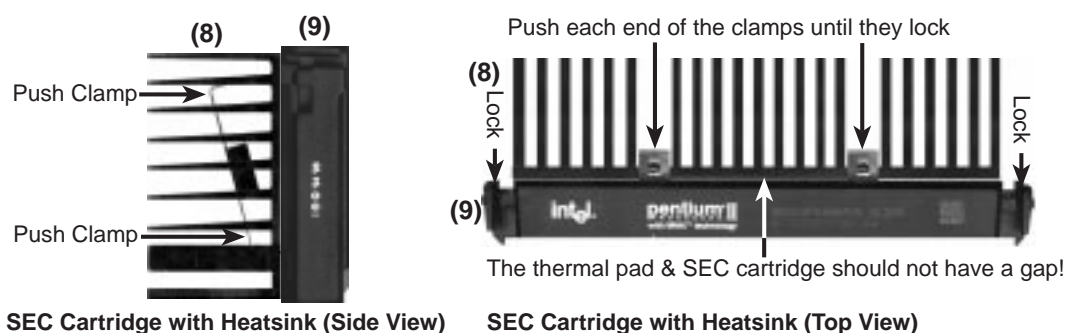

- 3. Insert the SEC Cartridge:** Push the SEC cartridge's two locks inward (the preceding picture shows the locks in the outward position and inward in the picture below). With the heatsink facing the motherboard's chipsets, press the cartridge gently but firmly until it is full inserted.

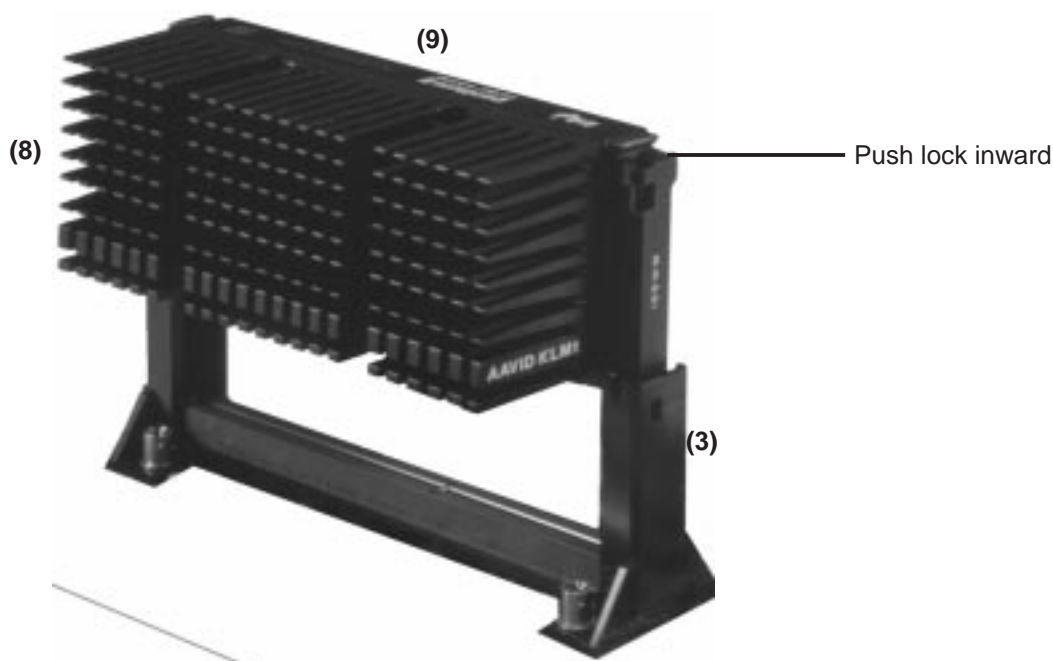

III. INSTALLATION

- Secure the SEC Cartridge:** Secure the SEC cartridge in place by pushing the SEC cartridge locks outward so that the lock shows through the retention mechanism's lock holes.

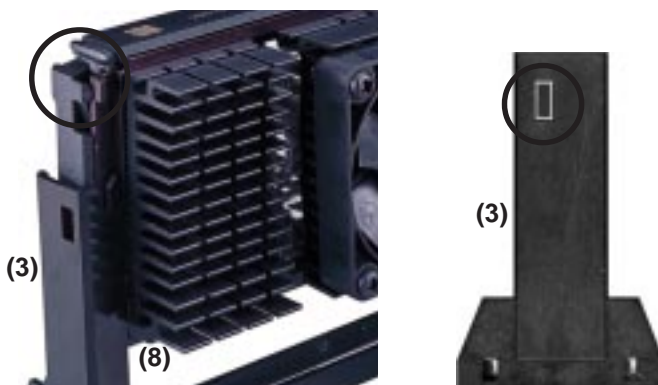

- Secure the Heatsink:** Install the heatsink support base into the motherboard. This is not, however, necessary if you use a heatsink with fan (see next page). The support base is necessary to secure the heatsink (without fan). Secure the heatsink by sliding the heatsink support top bar into the bottom groove of the heatsink until it locks into the heatsink support base posts.

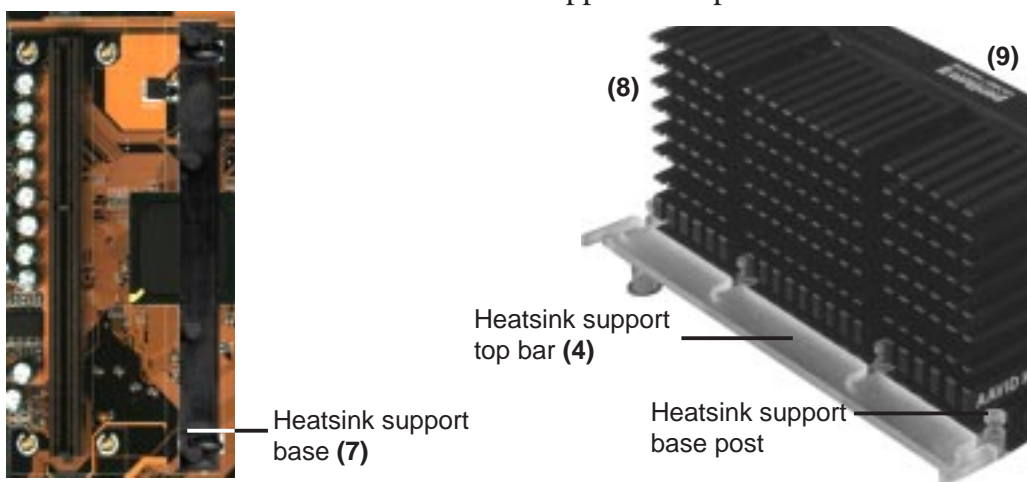

- Connect the Heat Sensor Cable to the R_CPU (optional):** If you purchased the specially designed fan and thermal monitor heatsink, you can connect the heat sensor cable to the motherboard's CPU heat sensor connector (R_CPU).

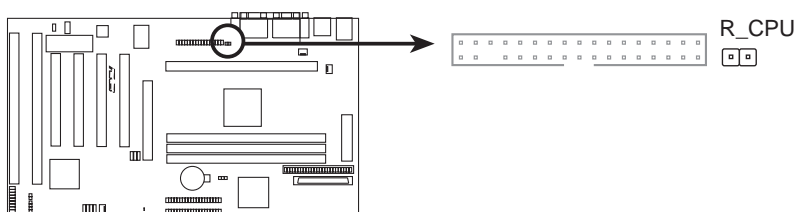

P2L97-S CPU Thermal Sensor Connector

III. INSTALLATION

The heatsinks shown in this manual are for reference purposes only. The recommended heatsinks for the Pentium II processor are those with three-pin fans that can be connected to the CPU fan connector on motherboard. These heatsinks have the added benefits of proper heat dissipation and with the LM78 hardware monitor, the ability to monitor the fan's RPM and use the alert function through the included LANdesk Client Manager (LDCM) software.

AAVID Heatsink



The procedures for installing the AAVID heatsink with fan is similar as that for the heatsink without a fan. You will not, however, be able to use the heatsink support top bar because of the fan. The heatsink support top bar will, however, still be included in the package, in case you use a heatsink without a fan.

Elan Vital Heatsink



The procedures for installing the Elan Vital heatsink with fan is also similar as that for the heatsink without a fan. The Elan Vital heatsink, however, comes with a lever to clamp the heatsink into the SEC cartridge. Mount the heatsink in the orientation as shown then flip the lever from “Unlock” to “Lock.” You will not be able to also use the heatsink support top bar because of the fan. The heatsink support top bar will, however, still be included in the package, in case you use a heatsink without a fan.

III. INSTALLATION

4. Expansion Cards

WARNING! Unplug your power supply when adding or removing expansion cards or other system components. Failure to do so may cause severe damage to both your motherboard and expansion cards.

First read your expansion card documentation for hardware and software settings that may be required to set up your specific card.

Expansion Card Installation Procedure

1. Read the documentation for your expansion card.
2. Set any necessary jumpers on your expansion card.
3. Remove your computer system's cover.
4. Remove the bracket on the slot you intend to use. Keep the bracket for possible future use.
5. Carefully align the card's connectors and press firmly.
6. Secure the card on the slot with the screw you removed in step 4.
7. Replace the computer system's cover.
8. Set up the BIOS if necessary
(such as *IRQ xx Used By ISA: Yes* in PNP AND PCI SETUP)
9. Install the necessary software drivers for your expansion card.

Assigning IRQs for Expansion Cards

Some expansion cards need to use an IRQ to operate. Generally an IRQ must be exclusively assigned to one use. In a standard design there are 16 IRQs available but most of them are already in use, leaving 6 IRQs free for expansion cards.

Both ISA and PCI expansion cards may require to use IRQs. System IRQs are available to cards installed in the ISA expansion bus first, then any remaining IRQs are available to PCI cards. Currently, there are two types of ISA cards. The original ISA expansion card design, now referred to as legacy ISA cards, requires that you configure the card's jumpers manually and then install it in any available slot on the ISA bus. You may use Microsoft Diagnostics (MSD.EXE) utility located in the Windows directory to see a map of your used and free IRQs. If you use Windows 95, the **Resources** tab under **Device Manager** displays the resource settings being used by a particular device (to gain access, double-click the **System** icon under the **Control Panel** program). Ensure that no two devices share the same IRQs or your computer will experience problems when those two devices are in use at the same time.

III. INSTALLATION

To simplify this process, this motherboard complies with the Plug and Play (PnP) specification, which was developed to allow automatic system configuration whenever a PnP-compliant card is added to the system. For PnP cards, IRQs are assigned automatically from those available.

If the system has both legacy and PnP ISA cards installed, IRQs are assigned to PnP cards from those not used by legacy cards. The PCI and PNP configuration section of the BIOS setup utility can be used to assign which IRQs are being used by legacy cards. For older legacy cards that do not work with the BIOS, you may contact your vendor for an ISA Configuration Utility.

An IRQ number is automatically assigned to PCI expansion cards after those used by legacy and PnP ISA cards. In the PCI bus design, the BIOS automatically assigns an IRQ to a PCI slot that contains a card requiring an IRQ. To install a PCI card, you need to set the INT (interrupt) assignment. Since all the PCI slots on this motherboard use an INTA #, set the jumpers on your PCI cards to INT A.

Assigning DMA Channels for ISA Cards

Some ISA cards, both legacy and PnP, may also need to use a DMA (Direct Memory Access) channel. DMA assignments for this motherboard are handled the same way as the IRQ assignment process described earlier. You can select a DMA channel in the PCI and PnP configuration section of the BIOS Setup utility.

IMPORTANT: To avoid conflicts, reserve the necessary IRQs and DMAs for legacy ISA cards (under PNP AND PCI SETUP of the BIOS SOFTWARE, choose *Yes* in *IRQ xx Used By ISA* and *DMA x Used By ISA* for those IRQs and DMAs you want to reserve).

ISA Cards and Hardware Monitor

The onboard hardware monitor uses the address 290H-297H so legacy ISA cards must not use this address or else conflicts will occur.

Accelerated Graphics Port

This motherboard provides an accelerated graphics port (AGP) slot to support a new generation of graphics cards with ultra-high memory bandwidth.

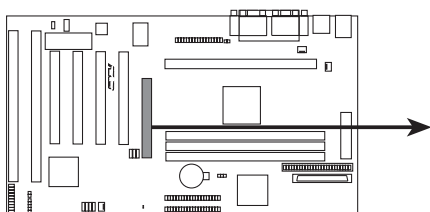

P2L97-S Accelerated Graphics Port (AGP)



III. INSTALLATION

5. External Connectors

WARNING! Some pins are used for connectors or power sources. Placing jumper caps over these will cause damage to your motherboard.

IMPORTANT: Ribbon cables should always be connected with the red stripe on the Pin 1 side of the connector. The four corners of the connectors are labeled on the motherboard. Pin 1 is the side closest to the power connector on hard drives and floppy drives. IDE ribbon cable must be less than 18in. (46cm), with the second drive connector no more than 6in. (15cm) from the first connector.

1. PS/2 Keyboard Connector (6-pin Female)

This connection is for a standard keyboard using an PS/2 plug (mini DIN). **This connector will not allow standard AT size (large DIN) keyboard plugs. You may use a DIN to mini DIN adapter on standard AT keyboards.**



PS/2 Keyboard (6-pin Female)

2. PS/2 Mouse Connector (6-pin Female)

The system will direct IRQ12 to the PS/2 mouse if one is detected. If not detected, expansion cards can use IRQ12. See “PS/2 Mouse Function Control” in BIOS Features Setup of the BIOS SOFTWARE.

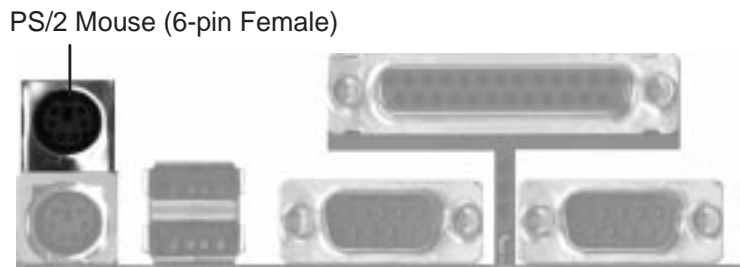

PS/2 Mouse (6-pin Female)

III. INSTALLATION

3. Parallel Printer Connector (25-pin Female)

You can enable the parallel port and choose the IRQ through “Onboard Parallel Port” in Chipset Features Setup of the BIOS SOFTWARE. **NOTE:** Serial printers must be connected to the serial port.

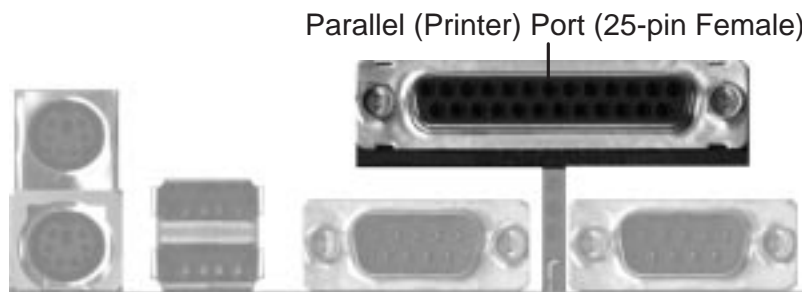

4. Serial Port COM1 and COM2 Connectors (Two 9-pin Male)

The two serial ports can be used for pointing devices or other serial devices. See “Onboard Serial Port...” in Chipset Features Setup of the BIOS SOFTWARE.

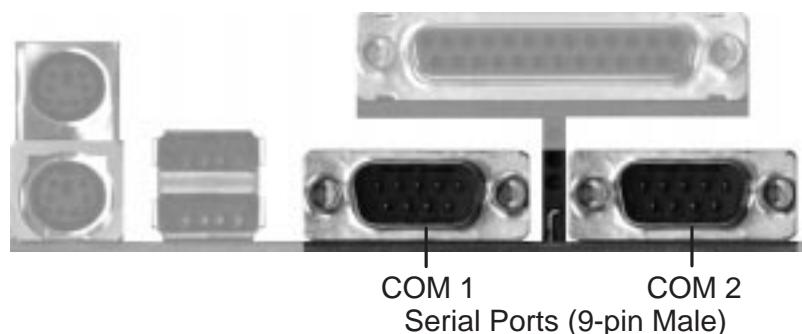

5. Floppy Disk Drive Connector (34-1pin FLOPPY)

This connector supports the provided floppy disk drive ribbon cable. After connecting the single end to the board, connect the two plugs on the other end to the floppy drives. **(Pin 5 is removed to prevent inserting in the wrong orientation when using ribbon cables with pin 5 plugged).**

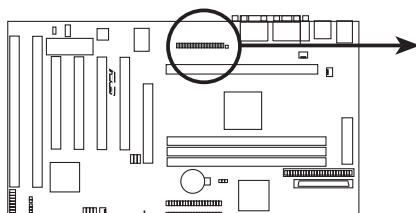

NOTE: Orient the red stripe to Pin 1

Pin 1 
Floppy Disk Drive Connector

P2L97-S Floppy Disk Drive Connector

III. INSTALLATION

6. Universal Serial BUS Ports 1 & 2 (Two 4-pin Female)

Two USB ports are available for connecting USB devices.

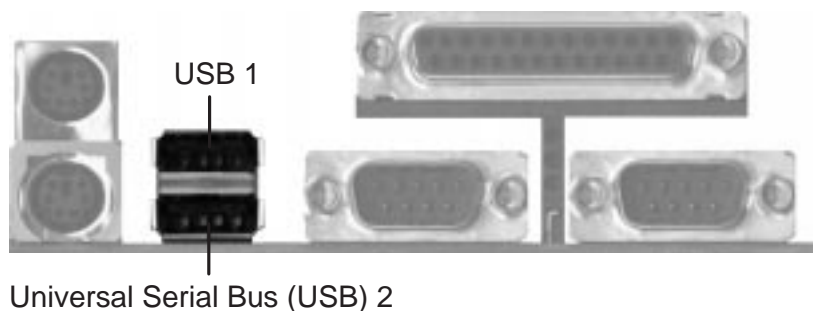

7. Primary / Secondary IDE connectors (Two 40-1pin IDE)

These connectors support the provided IDE hard disk ribbon cable. After connecting the single end to the board, connect the two plugs at the other end to your hard disk(s). If you install two hard disks, you must configure the second drive to Slave mode by setting its jumper accordingly. Please refer to the documentation of your hard disk for the jumper settings. BIOS now supports SCSI device or IDE CD-ROM bootup (see “HDD Sequence SCSI/IDE First” & “Boot Sequence” in the **BIOS Features Setup** of the BIOS SOFTWARE) (**Pin 20 is removed to prevent inserting in the wrong orientation when using ribbon cables with pin 20 plugged**).

TIP: You may configure two hard disks to be both Masters using one ribbon cable on the primary IDE connector and another ribbon cable on the secondary IDE connector. You may install one operating system on an IDE drive and another on a SCSI drive and select the boot disk through BIOS Features Setup.

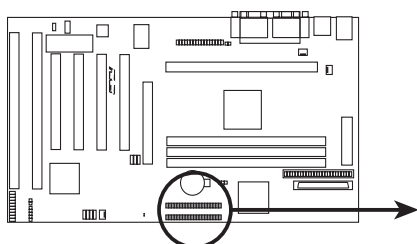

P2L97-S IDE Connectors

NOTE: Orient the red stripe to Pin 1

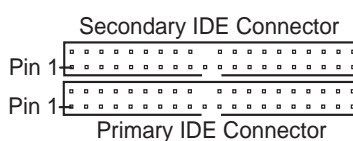

III. INSTALLATION

8. Hard Disk Activity LED (2-pin HDLED)

This connector supplies power to the cabinet's hard disk or IDE activity LED. Read and write activity by devices connected to the Primary or Secondary IDE connectors will cause the LED to light up.

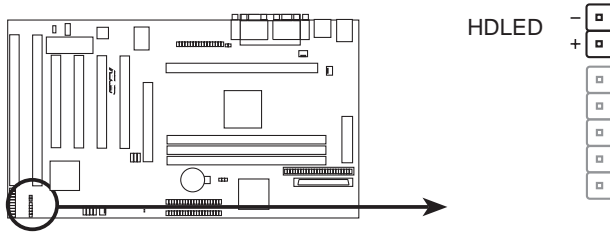

P2L97-S Hard Disk Activity LED

TIP: If the case-mounted LED does not light, try reversing the 2-pin plug.

9. Chassis , CPU , & Power Supply Fan Connectors (3-pin FANPWR)

These connectors support cooling fans of 500mAMP (6WATT) or less. Orientate the fans so that the heat sink fins allow airflow to go across the onboard heat sink(s) instead of the expansion slots. Depending on the fan manufacturer, the wiring and plug may be different. The red wire should be positive, while the black should be ground. Connect the fan's plug to the board taking into consideration the polarity of the this connector.

NOTE: The "Rotation" signal is to be used only by a specially designed fan with rotation signal.

WARNING! The CPU and/or motherboard will overheat if there is no airflow across the CPU and onboard heatsinks. Damage may occur to the motherboard and/or the CPU fan if these pins are incorrectly used. **These are not jumpers, do not place jumper caps over these pins.**

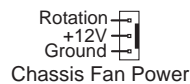
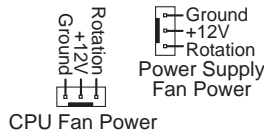
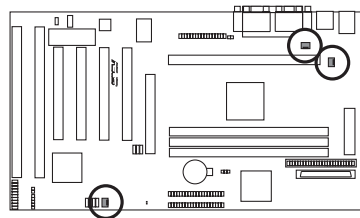

P2L97-S 12Volt Cooling Fan Power

III. INSTALLATION

10. IrDA-Compliant infrared module connector (5-pin IR)

This connector supports the optional wireless transmitting and receiving infrared module. This module mounts to a small opening on system cases that support this feature. You must also configure the setting through “UART2 Use Infrared” in **Chipset Features Setup** to select whether UART2 is directed for use with COM2 or IrDA. Use the five pins as shown on the Back View and connect a ribbon cable from the module to the motherboard according to the pin definitions.

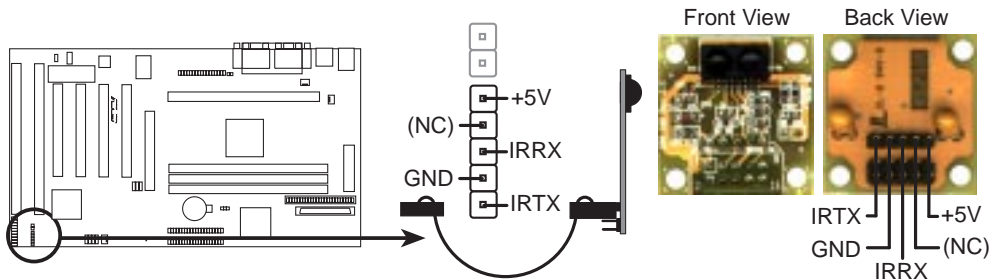

P2L97-S Infrared Module Connector

For the infrared feature to be available, you must connect the optional Infrared (IrDA) module to the motherboard

11. ATX Power Supply Connector (20-pin ATXPWR)

This connector connects to a ATX power supply. The plug from the power supply will only insert in one orientation because of the different hole sizes. Find the proper orientation and push down firmly but gently making sure that the pins are aligned.

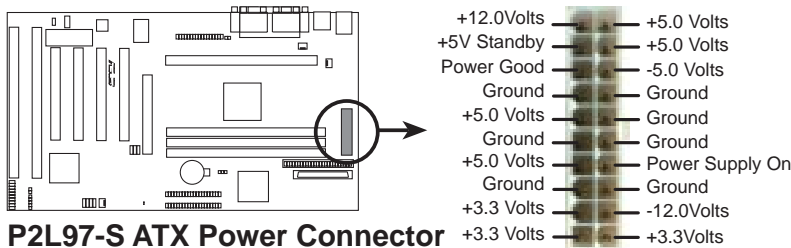

P2L97-S ATX Power Connector

IMPORTANT: Make sure that your ATX power supply can supply at least 10mAmp on the 5-volt standby lead (5VSB). You may experience difficulty in powering on your system if your power supply cannot support the load. For Wake on LAN support, your ATX power supply must supply at least 720mAmp.

III. INSTALLATION

12. Wake on LAN (3-pin WOL) (Reserved for future use)

This connector connects to LAN cards with a Wake On LAN output. When the system is in soft-off mode, LAN activity will power on the system.

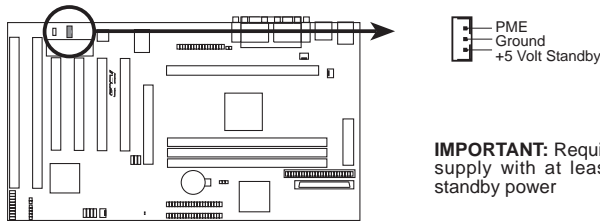

IMPORTANT: Requires an ATX power supply with at least 720ma +5-volt standby power

P2L97-S Wake on LAN Connector

13. Ultra-Fast SCSI & Ultra-Wide SCSI Connectors

This motherboard has onboard 50-Pin Ultra-Fast SCSI connector for 8-bit SCSI devices and 68-Pin Ultra-Wide SCSI connector for 16-bit SCSI devices.

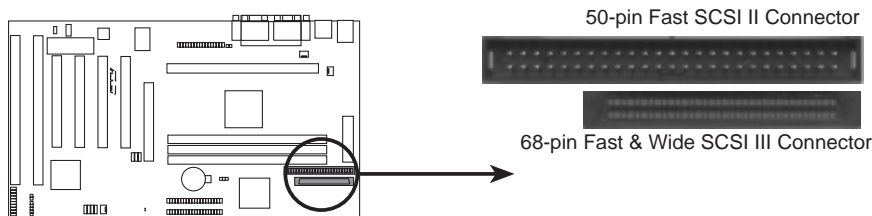

P2L97-S Onboard SCSI Connectors

IMPORTANT: The 68-Pin Ultra-Wide SCSI Connector is always terminated and will only work as an end device.

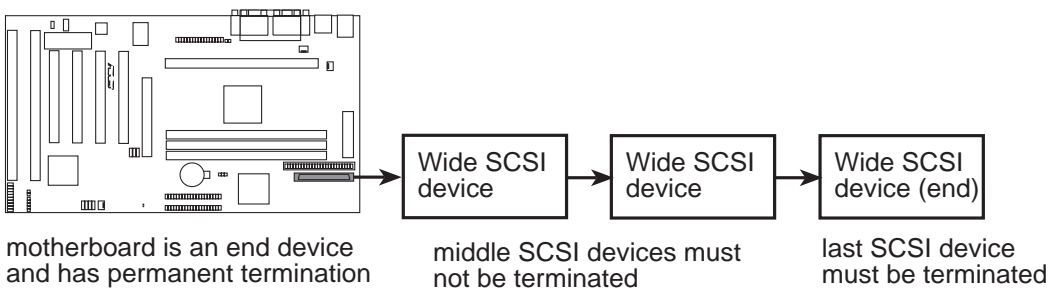

NOTE: Up to 15 devices can be connected with 50-Pin Fast-SCSI and 68-Pin Ultra-Wide SCSI combined.

III. INSTALLATION
(Connectors)

III. INSTALLATION

14. LED Lead (TB_LED)

This indicates whether a message has been received from a fax/modem. The LED will remain lit when there is no signal and blink when there is data transfer or waiting in the inbox. This function requires OS and driver support.

15. SMI Suspend Switch Lead (SMI)

This allows the user to manually place the system into a suspend mode or “Green” mode where system activity will be decreased to save electricity and expand the life of certain components when the system is not in use. This 2-pin connector connects to the case-mounted suspend switch. If you do not have a switch for the connector, you may use the “Turbo Switch”. SMI is activated when it detects a *short to open* moment and therefore leaving it shorted will not cause any problems. This may require one or two presses depending on the position of the switch. Wake-up can be controlled by settings in the BIOS but the keyboard will always allow wake-up (the SMI lead cannot wake up the system). If you want to use this connector, set “Suspend Mode” under the **Power Management Setup** of the BIOS SOFTWARE section to the preferred time after which the system must go into suspend mode when you press the switch.

16. ATX Power Switch / Soft Power Switch (PWR_SW)

The system power is controlled by a momentary switch connected to this lead. Pressing the button once will switch the system between ON and SLEEP. Pressing the switch while in the ON mode for more than 4 seconds will turn the system off. The system power LED shows the status of the system’s power.

17. Reset Switch Lead (RESET)

This 2-pin connector connects to the case-mounted reset switch for rebooting your computer without having to turn off your power switch. This is a preferred method of rebooting to prolong the life of the system’s power supply.

18. System Power LED (KEYLOCK)

This 3-pin connector connects the system power LED, which lights when the system is powered on and blinks when it is in sleep mode.

19. Keyboard Lock Switch Lead (KEYLOCK)

This 2-pin connector connects to the case-mounted key switch to allow keyboard locking.

20. Speaker Connector (SPEAKER)

This 4-pin connector connects to the case-mounted speaker.

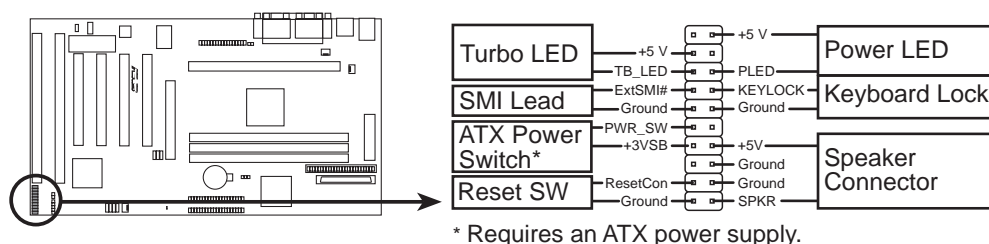

P2L97-S System Panel Connections

III. INSTALLATION

Power Connection Procedures

1. After all jumpers and connections are made, close the system case cover.
 2. Be sure that all switches are off (in some systems, marked with ○).
 3. Connect the power supply cord into the power supply located on the back of your system case according to your system user's manual.
 4. Connect the power cord into a power outlet that is equipped with a surge protector.
 5. You may then turn on your devices in the following order:
 - a. Your monitor
 - b. External SCSI devices (starting with the last device on the chain)
 - c. Your system power. For ATX power supplies, you need to switch on the power supply as well as press the ATX power switch on the front of the case.
 6. The power LED on the front panel of the system case will light. For ATX power supplies, the system LED will light when the ATX power switch is pressed. The monitor LED may light up after the system's if it complies with "green" standards or if it has a power standby feature. The system will then run power-on tests. While the tests are running, additional messages will appear on the screen. If you do not see anything within 30 seconds from the time you turn on the power, the system may have failed a power-on test. Recheck your jumper settings and connections or call your retailer for assistance.
 7. During power-on, hold down <Delete> to enter BIOS setup. Follow the instructions in the next section, BIOS SOFTWARE.
- * **Powering Off your computer:** You must first exit or shut down your operating system before switching off the power switch. For ATX power supplies, you can press the ATX power switch after exiting or shutting down your operating system. If you use Windows 95, click the **Start** button, click **Shut Down**, and then click **Shut down the computer?**. The system will give three quick beeps after about 30 seconds and then power off after Windows shuts down.

NOTE: The message "You can now safely turn off your computer" will not appear when shutting down with ATX power supplies.

IV. BIOS SOFTWARE

Flash Memory Writer Utility

This motherboard has an onboard SCSI BIOS and boot virus protection and therefore, requires a 2Mbit flash ROM.

AFLASH.EXE: This is the Flash Memory Writer utility that updates the BIOS by uploading a new BIOS file to the 2Mbit programmable flash ROM chip on the motherboard. To determine the BIOS version of your motherboard, check the last four numbers of the code displayed on the upper left-hand corner of your screen during bootup. Larger numbers represent a newer BIOS file. This file works only in DOS mode.

NOTE: The following screen displays are provided as examples only and may not reflect the screen contents displayed on your system.

```
ACPI BIOS
FLASH MEMORY WRITER V1.0
Copyright (C) 1994-99, ASUSTek COMPUTER INC.

Flash Memory: 32T 2MbitROM

Current BIOS Version: ASUS P2B ACPI BIOS Revision 5001
Chipset and Model : 1440EX-F2B
BIOS Build Date : 03/21/98

Choose one of the followings:
1. Save Current BIOS To File
2. Update BIOS Including Boot Block and EBDS

Enter choice: [1]

Press ESC to Exit
```

IMPORTANT! If “unknown” is displayed after **Flash Memory:**, the memory chip is either not programmable or is not supported by the ACPI BIOS and therefore, cannot be programmed by the Flash Memory Writer utility.

Main Menu

1. Save Current BIOS To File

This option allows you to save a copy of the original motherboard BIOS in case you need to reinstall it. It is recommended that you save **AFLASH.EXE** and the BIOS file to a bootable floppy disk.

To save your current BIOS, type [1] at the **Main Menu** and then press <Enter>. The **Save Current BIOS To File** screen appears.

Type a filename and the path, for example, **A:\440XX-1** and then press <Enter>.

```
Save Current BIOS To File

Flash Memory: 32T 2MbitROM

Current BIOS Version: ASUS P2B ACPI BIOS Revision 5001
Chipset and Model : 1440EX-F2B
BIOS Build Date : 03/21/98

Please Enter File Name to Save: A:\440XX-1
```

IV. BIOS SOFTWARE

2. Update BIOS Including Boot Block and ESCD

This option updates the boot block, the baseboard BIOS, and the ACPI extended system configuration data (ESCD) parameter block from a new BIOS file. See the next page for procedures on downloading an updated BIOS file.

To update your current BIOS, type [2] at the **Main Menu** and then press <Enter>. The **Update BIOS Including Boot Block and ESCD** screen appears. Type the filename of your new BIOS and the path, for example, **A:\XX2I1001.AWD**, and then press <Enter>.

When prompted to confirm the BIOS update, press **Y** to start the update.

The utility starts to program the new BIOS information into the flash ROM. When the programming is finished, *Flashed Successfully* will be displayed.

Follow the onscreen instructions to continue.

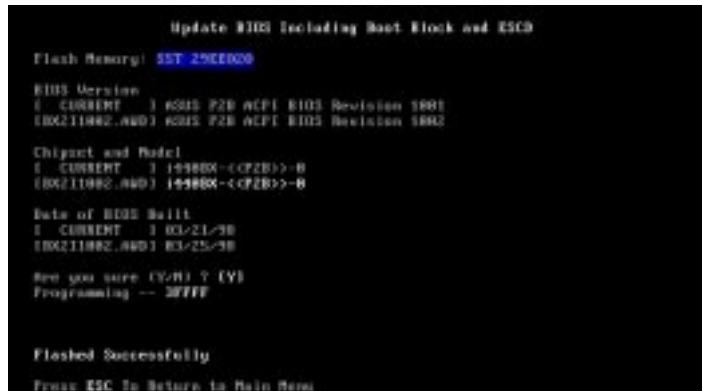
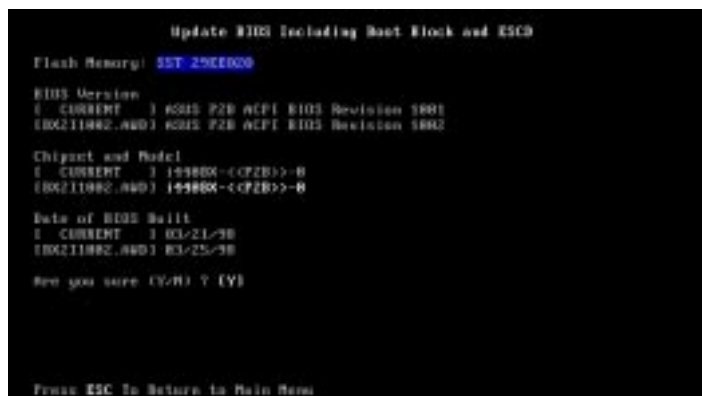
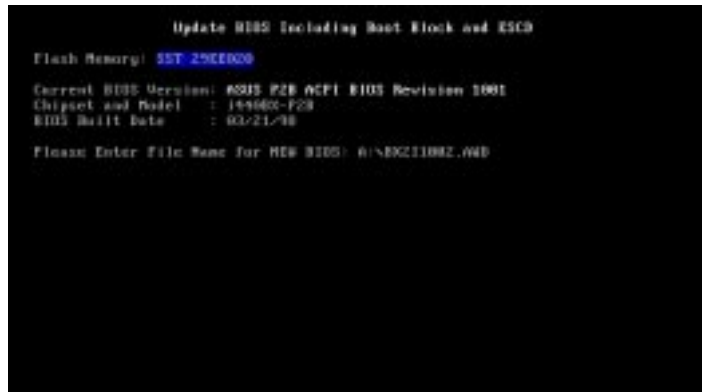

IV. BIOS
(Flash Memory Writer)

IV. BIOS SOFTWARE

Managing and Updating Your Motherboard's BIOS

Upon First Use of the Computer System

1. Create a bootable system floppy disk by typing [FORMAT A:/S] from the DOS prompt without creating "AUTOEXEC.BAT" and "CONFIG.SYS" files.
2. Copy AFLASH.EXE to the just created boot disk.
3. Run AFLASH.EXE from this new disk and select option **1. Save Current BIOS to File**. See **1. Save Current BIOS To File** on the previous page for more details and the rest of the steps.

Updating BIOS Procedures (only when necessary)

1. Download an updated ASUS BIOS file from the Internet (WWW or FTP) or a BBS (Bulletin Board Service) (see ASUS CONTACT INFORMATION on page 3 for details) and save to the disk you created earlier.
2. Boot from the disk you created earlier.
3. At the "A:\>" prompt, type **AFLASH** and then press <Enter>.
4. At the **Main Menu**, type **2** and then press <Enter>. See **2. Update BIOS Including Boot Block and ESCD** on the previous page for more details and the rest of the steps.

WARNING! If you encounter problems while updating the new BIOS, DO NOT turn off your system since this might prevent your system from booting up. Just repeat the process, and if the problem still persists, update the original BIOS file you saved to disk above. If the Flash Memory Writer utility was not able to successfully update a complete BIOS file, your system may not be able to boot up. If this happens, your system will need service.

IV. BIOS SOFTWARE

6. BIOS Setup

The motherboard supports two programmable Flash ROM chips: 5-Volt and 12-Volt. Either of these memory chips can be updated when BIOS upgrades are released. Use the Flash Memory Writer utility to download the new BIOS file into the ROM chip as described in detail in this section.

All computer motherboards provide a Setup utility program for specifying the system configuration and settings. If your motherboard came in a computer system, the proper configuration entries may have already been made. If so, invoke the Setup utility, as described later, and take note of the configuration settings for future reference; in particular, the hard disk specifications.

If you are installing the motherboard, reconfiguring your system or you receive a Run Setup message, you will need to enter new setup information. This section describes how to configure your system using this utility.

The BIOS ROM of the system stores the Setup utility. When you turn on the computer, the system provides you with the opportunity to run this program. This appears during the Power-On Self Test (POST). Press <Delete> to call up the Setup utility. If you are a little bit late pressing the mentioned key(s), POST will continue with its test routines, thus preventing you from calling up Setup. If you still need to call Setup, reset the system by pressing <Ctrl> + <Alt> + <Delete>, or by pressing the Reset button on the system case. You can also restart by turning the system off and then back on again. But do so only if the first two methods fail.

When you invoke Setup, the CMOS SETUP UTILITY main program screen will appear with the following options:



IV. BIOS SOFTWARE

Load Defaults

The “Load BIOS Defaults” option loads the minimum settings for troubleshooting. “**Load Setup Defaults**”, on the other hand, is for loading optimized defaults for regular use. Choosing defaults at this level, will modify all applicable settings.

A section at the bottom of the above screen displays the control keys for this screen. Take note of these keys and their respective uses. Another section just below the control keys section displays information on the currently highlighted item in the list.

Standard CMOS Setup

This “Standard CMOS Setup” option allows you to record some basic system hardware configuration and set the system clock and error handling. If the motherboard is already installed in a working system, you will not need to select this option anymore. However, if the configuration stored in the CMOS memory on the board gets lost or damaged, or if you change your system hardware configuration, you will need to respecify the configuration values. The configuration values usually get lost or corrupted when the power of the onboard CMOS battery weakens.



The preceding screen provides you with a list of options. At the bottom of this screen are the control keys for this screen. Take note of these keys and their respective uses.

User-configurable fields appear in a different color. If you need information on the selected field, press <F1>. The help menu will then appear to provide you with the information you need. The memory display at the lower right-hand side of the screen is read-only and automatically adjusts accordingly.

Details of Standard CMOS Setup:

Date

To set the date, highlight the “Date” field and then press either <Page Up>/<Page Down> or <+>/<-> to set the current date. Follow the month, day and year format. Valid values for month, day and year are: **Month: (1 to 12), Day: (1 to 31), Year: (up to 2079)**

IV. BIOS SOFTWARE

Time

To set the time, highlight the “Time” field and then press either <Page Up>/<Page Down> or <+>/<-> to set the current time. Follow the hour, minute and second format. Valid values for hour, minute and second are: (**Hour: (00 to 23)**), (**Minute: (00 to 59)**), (**Second: (00 to 59)**). Press <Enter> twice if you do not want to modify the current time.

NOTE: You can bypass the date and time prompts by creating an AUTOEXEC.BAT file. For information on how to create this file, please refer to the MS-DOS manual.

Hard Disks

This field records the specifications for all non-SCSI hard disk drives installed in your system. The onboard PCI IDE connectors provide Primary and Secondary channels for connecting up to four IDE hard disks or other IDE devices. Each channel can support up to two hard disks; the first of which is the “master” and the second is the “slave”.

Specifications for SCSI hard disks need not to be entered here since they operate using device drivers and are not supported by the BIOS. If you install other SCSI controller cards, refer to their respective documentations on how to install the required SCSI drivers.

For IDE hard disk drive setup, you can:

- Use the *Auto* setting for detection during bootup.
- Use the IDE HDD AUTO DETECTION in the main menu to automatically enter the drive specifications.
- Enter the specifications yourself manually by using the “User” option.

The entries for specifying the hard disk type include **CYLS** (number of cylinders), **HEAD** (number of read/write heads), **PRECOMP** (write precompensation), **LANDZ** (landing zone), **SECTOR** (number of sectors) and **MODE**. The **SIZE** field automatically adjusts according to the configuration you specify. The documentation that comes with your hard disk should provide you with the information regarding the drive specifications.

The **MODE** entry is for IDE hard disks only, and can be ignored for MFM and ESDI drives. This entry provides three options: *Normal*, *Large*, *LBA*, or *Auto* (see below). Set **MODE** to the *Normal* for IDE hard disk drives smaller than 528MB; set it to *LBA* for drives over 528MB that support Logical Block Addressing (LBA) to allow larger IDE hard disks; set it to *Large* for drives over 528MB that do not support LBA. *Large* type of drive can only be used with MS-DOS and is very uncommon. Most IDE drives over 528MB support the *LBA* mode.

IV. BIOS SOFTWARE

Auto detection of hard disks on bootup

For each field: Primary Master, Primary Slave, Secondary Master, and Secondary Slave, you can select *Auto* under the TYPE and MODE fields. This will enable auto detection of your IDE hard disk during bootup. This will allow you to change your hard disks (with the power off) and then power on without having to reconfigure your hard disk type. If you use older hard disks that do not support this feature, then you must configure the hard disk in the standard method as described earlier by the “User” option.

NOTE: After the IDE hard disk drive information has been entered into BIOS, new IDE hard disk drives must be partitioned (such as with FDISK) and then formatted before data can be read from and write on. Primary IDE hard disk drives must have its partition set to *active* (also possible with FDISK).

NOTE: SETUP Defaults are noted in parenthesis next to each function heading.

Drive A / Drive B (None)

These fields record the types of floppy disk drives installed in your system. The available options for drives A and B are: *360KB, 5.25 in.; 1.2MB, 5.25 in.; 720KB, 3.5 in.; 1.44MB, 3.5 in.; 2.88MB, 3.5 in.; None*

To enter the configuration value for a particular drive, highlight its corresponding field and then select the drive type using the left- or right-arrow keys.

Floppy 3 Mode Support (Disabled)

This is the Japanese standard floppy drive. The standard stores 1.2MB in a 3.5inch diskette. This is normally disabled but you may choose from either: *Drive A, Drive B, Both, and Disabled*

Video (EGA/VGA)

Set this field to the type of video display card installed in your system. The options are *EGA/VGA, CGA 49, CGA 80, and Mono* (for Hercules or MDA).

If you are using a VGA or any higher resolution card, choose *EGA/VGA*.

Halt On (All Errors)

This field determines which types of errors will cause the system to halt. Choose from *All Errors; No Errors; All,But Keyboard, All,But Diskette; and All,But Disk/Key*.

IV. BIOS SOFTWARE

BIOS Features Setup

This “BIOS Features Setup” option consists of configuration entries that allow you to improve your system performance, or let you set up some system features according to your preference. Some entries are required by the motherboard’s design to remain in their default settings.



A section at the lower right of the screen displays the control keys you can use. Take note of these keys and their respective uses. If you need information on a particular entry, highlight it and then press <F1>. A pop-up help menu will appear to provide you with the information you need. <F5> loads the last set values, <F6> and <F7> loads the BIOS default values and Setup default values, respectively.

NOTE: SETUP Defaults are noted in parenthesis next to each function heading.

Details of BIOS Features Setup

CPU Internal Core Speed

This function is reserved for future use and is currently disabled.

Boot Virus Detection (Enabled)

This field allows you to set boot virus detection, ensuring a virus-free boot sector. This new antivirus solution is unlike native BIOS tools, which offer limited virus protection typically by write-protecting the partition table. With this new solution, your computer is protected against boot virus threats earlier in the boot cycle, that is, before they have a chance to load into your system. This ensures your computer boots to a clean operating system. The system halts and displays a warning message when it detects a virus. If this occurs, you can either allow the operation to continue or use a virus-free bootable floppy disk to restart and investigate your system. Because of conflicts with new operating systems, for example, during installation of new softwares, you may have to set this to *Disabled* to prevent write errors.

IV. BIOS SOFTWARE

CPU Level 1 Cache / CPU Level 2 Cache (Enabled)

These fields allow you to choose from the default of *Enabled* or choose *Disabled* to turn on or off the CPU's Level 1 and Level 2 built-in cache.

CPU Level 2 Cache ECC Check (Disabled)

This function controls the ECC check capability in the CPU level 2 cache.

BIOS Update (Enabled)

This functions as an update loader integrated into the BIOS to supply the processor with the required data. The BIOS will load the update on all processors during system bootup in the default position of *Enabled*.

Quick Power On Self Test (Enabled)

This field speeds up the Power-On Self Test (POST) routine by skipping retesting a second, third, and fourth time. Setup default setting for this field is *Enabled*. A complete test of the system is done on each test.

HDD Sequence SCSI/IDE First (IDE)

When using both SCSI and IDE hard disk drives, IDE is always the boot disk using drive letter C (default setting of *IDE*). This new feature allows a SCSI hard disk drive to be the boot disk when set to *SCSI*. This allows multiple operating systems to be used on both IDE and SCSI drives or the primary operating system to boot using a SCSI hard disk drive.

Boot Sequence (A,C)

This field determines where the system looks first for an operating system. Options are *A,C*; *A,CDROM,C*; *CDROM,C,A*; *D,A*; *E,A*; *F,A*; *C only*; *LS/ZIP, C*; and *C,A*. The setup default setting, *A, C*, is to check first the floppy disk and then the hard disk drive.

Boot Up Floppy Seek (Disabled)

When enabled, the BIOS will seek drive A once.

Floppy Disk Access Control (R/W)

This allows protection of files from the computer system to be copied to floppy disks by allowing the setting of *Read Only* to only allow reads from the floppy disk drive but not writes. The setup default *R/W* allows both reads and writes.

IDE HDD Block Mode Sectors (HDD MAX)

This field enhances hard disk performance by making multi-sector transfers instead of one sector per transfer. Most IDE drives, except older versions, can utilize this feature. Selections are *HDD MAX*, *Disabled*, *2*, *4*, *8*, *16*, and *32*.

HDD S.M.A.R.T Capability (Disabled)

This field enables or disables S.M.A.R.T. IDE hard disk drive features.

IV. BIOS SOFTWARE

Security Option (System)

When you specify a *Supervisor Password* and/or *User Password* (explained later in this section), the Security Option field determines when the system prompts for the password. The default setting is **System**, where the system prompts for the User Password every time you start your system. The other option is *Setup*, where the system goes through its startup routine unless the Setup utility is called, when the system prompts for the Supervisor Password.

PS/2 Mouse Function Control (Auto)

The default of *Auto* allows the system to detect a PS/2 mouse on bootup. If detected, IRQ12 will be used for the PS/2 mouse. IRQ12 will be reserved for expansion cards if a PS/2 mouse is not detected. *Enabled* will always reserve IRQ12, whether on bootup a PS/2 mouse is detected or not.

PCI/VGA Palette Snoop (Disabled)

Some display cards that are nonstandard VGA such as graphics accelerators or MPEG Video Cards may not show colors properly. The setting *Enabled* should correct this problem. Otherwise leave this on the setup default setting of *Disabled*.

OS/2 Onboard Memory > 64M (Disabled)

When using OS/2 operating systems with installed DRAM of greater than 64MB, you need to set this option to *Enabled* otherwise leave this on *Disabled*.

.....

Video ROM BIOS Shadow (Enabled)

This field allows you to change the video BIOS location from ROM to RAM. Relocating to RAM enhances system performance, as information access is faster than the ROM.

C8000-CBFFF to DC000-DFFFF (Disabled)

These fields are used for shadowing other expansion card ROMs. If you install other expansion cards with ROMs on them, you will need to know which addresses the ROMs use to shadow them specifically. Shadowing a ROM reduces the memory available between 640K and 1024K by the amount used for this purpose.

Boot Up NumLock Status (On)

This field enables users to activate the Number Lock function upon system boot.

Typematic Rate Setting (Disabled)

When enabled, you can set the two typematic controls listed next. Setup default setting is *Disabled*.

Typematic Rate (Chars/Sec) (6)

This field controls the speed at which the system registers repeated keystrokes. Options range from 6 to 30 characters per second. Setup default setting is **6**; other settings are 8, 10, 12, 15, 20, 24, and 30.

Typematic Delay (Msec) (250)

This field sets the time interval for displaying the first and second characters. Four delay rate options are available: 250, 500, 750, and 1000.

IV. BIOS SOFTWARE

Chipset Features Setup

This “Chipset Features Setup” option controls the configuration of the board’s chipset. Control keys for this screen are the same as in the previous screen.



NOTE: SETUP Defaults are noted in parenthesis next to each function heading.

Details of Chipset Features Setup

EDO Auto Configuration (60ns DRAM)

The default setting of *60ns DRAM* sets the optimal timings for items 2 through 5 for 60ns DRAM modules. If you are using 70ns DRAM modules, you must change this item to *70ns DRAM*. See section III for DRAM installation information.

SDRAM Configuration (12ns SDRAM)

Leave on default setting.

SDRAM RAS to CAS Delay (Auto)

Leave on default setting.

SDRAM RAS Precharge Time (Auto)

Leave on default setting.

MA Wait State (Auto)

Leave on default setting.

SDRAM Banks Close Policy (Arbitration)

Leave on default setting.

16-bit I/O Recovery Time (1 BUSCLK)

Timing for 16-bit ISA cards. Leave on default setting.

8-bit I/O Recovery Time (1 BUSCLK)

Timing for 8-bit ISA cards. Leave on default setting.

Graphics Aperture Size (64MB)

Leave on default setting.

IV. BIOS SOFTWARE

Video Memory Cache Mode (UC)

USWC (uncacheable, speculative write combining) is a new cache technology for the video memory of the processor. It can greatly improve the display speed by caching the display data. You must leave this on the default setting of UC (uncacheable) if your display card cannot support this feature or else your system may not boot.

PCI 2.1 Support (Enabled)

This function allows you to enable or disable PCI 2.1 features. Leave on the default *Enabled* setting for PCI 2.1 compliancy.

Memory Hole At 15M–16M (Disabled)

Enabling this feature reserves 15MB to 16MB memory address space to ISA expansion cards that specifically require this setting. This makes the memory from 15MB and up unavailable to the system. Expansion cards can only access memory up to 16MB. The default is *Disabled*.

DRAM are xx bits wide

If all your DRAM modules have parity chips (e.g., 8 chips + 4 parity chips), they are considered 36bits. This motherboard sums the memory per bank and therefore two modules will give 72bits and the following will be displayed:

```
DRAM are 72 bits wide
Data Integrity Mode : ECC
ESC : Quit          ↑↓+* : Select Item
F1 : Help          PU/PD/+/- : Modify
F5 : Old Values    (Shift)F2 : Color
F6 : Load BIOS Defaults
F7 : Load Setup Defaults
```

If your DRAM modules do not have parity chips (e.g., 8 chips), they are considered 32bits and the following will be displayed instead:

```
DRAM are 64 (Not 72) bits wide
Data Integrity Mode : Non-ECC
ESC : Quit          ↑↓+* : Select Item
F1 : Help          PU/PD/+/- : Modify
F5 : Old Values    (Shift)F2 : Color
F6 : Load BIOS Defaults
F7 : Load Setup Defaults
```

Data Integrity Mode (Non-ECC)

Non-ECC has byte-wise write capability but no provision for protecting data integrity in the DRAM array. *EC-Only* data errors are detected but not corrected. *ECC* allows a detection of single-bit and multiple-bit errors and recovery of single-bit errors. (See section III for more information on DRAM memory modules.)

Onboard FDC Controller (Enabled)

When *Enabled*, this field allows you to connect your floppy disk drives to the onboard floppy disk drive connector instead of a separate controller card. If you want to use a different controller card to connect the floppy disk drives, set this field to *Disabled*.

IV. BIOS SOFTWARE

Onboard FDC Swap A & B (No Swap)

This field allows you to reverse the hardware drive letter assignments of your floppy disk drives. Two options are available: *No Swap* and *Swap AB*. If you want to switch drive letter assignments through the onboard chipset, set this field to *Swap AB*.

Onboard Serial Port 1 (3F8H/IRQ4)

Settings are *3F8H/IRQ4*, *2F8H/IRQ3*, *3E8H/IRQ4*, *2E8H/IRQ10*, and *Disabled* for the onboard serial connector.

Onboard Serial Port 2 (2F8H/IRQ3)

Settings are *3F8H/IRQ4*, *2F8H/IRQ3*, *3E8H/IRQ4*, *2E8H/IRQ10*, and *Disabled* for the onboard serial connector.

Onboard Parallel Port (378H/IRQ7)

This field sets the address of the onboard parallel port connector. You can select either: *3BCH/IRQ 7*, *378H/IRQ 7*, *278H/IRQ 5*, *Disabled*. If you install an I/O card with a parallel port, ensure that there is no conflict in the address assignments. The PC can support up to three parallel ports as long as there are no conflicts for each port.

Parallel Port Mode (ECP+EPP)

This field allows you to set the operation mode of the parallel port. The setting *Normal*, allows normal-speed operation but in one direction only; *EPP* allows bidirectional parallel port operation at maximum speed; *ECP* allows the parallel port to operate in bidirectional mode and at a speed faster than the maximum data transfer rate; *ECP+EPP* allows normal speed operation in a two-way mode.

ECP DMA Select (3)

This selection is available only if you select *ECP* or *ECP+EPP* in the **Parallel Port Mode**. Select either DMA Channel *1*, *3*, or *Disable*.

UART2 Use Infrared (Disabled)

When enabled, this field activates the onboard infrared feature and sets the second serial UART to support the infrared module connector on the motherboard. If your system already has a second serial port connected to the onboard COM2 connector, it will no longer work if you enable the infrared feature. By default, this field is set to *Disabled*, which leaves the second serial port UART to support the COM2 serial port connector. See **IrDA-compliant infrared module connector** under section III.

Onboard PCI IDE Enable (Both)

You can select to enable the *primary* IDE channel, *secondary* IDE channel, *both*, or *disable* both channels (for systems with only SCSI drives).

IDE 0 Master/Slave PIO/DMA Mode, IDE 1 Master/Slave PIO/DMA Mode (Auto)

Each channel (0 and 1) has both a master and a slave making four IDE devices possible. Because each IDE device may have a different Mode timing (*0*, *1*, *2*, *3*, *4*), it is necessary for these to be independent. The default setting of *Auto* will allow auto-detection to ensure optimal performance.

IV. BIOS SOFTWARE

Power Management Setup

This “Power Management Setup” option allows you to reduce power consumption. This feature turns off the video display and shuts down the hard disk after a period of inactivity.



NOTE: SETUP Defaults are noted in parenthesis next to each function heading.

Details of Power Management Setup

Power Management (User Define)

This field acts as the master control for the power management modes. *Max Saving* puts the system into power saving mode after a brief period of system inactivity; *Min Saving* is almost the same as *Max Saving* except that this time the system inactivity period is longer; *Disable* disables the power saving features; *User Define* allows you to set power saving options according to your preference.

IMPORTANT: Advanced Power Management (APM) should be installed to keep the system time updated when the computer enters suspend mode activated by the BIOS Power Management. For DOS environments, you need to add the statement, `DEVICE=C:\DOS\POWER.EXE`, in your `CONFIG.SYS`. For Windows 3.x and Windows 95, you need to install Windows with the APM feature. A battery and power cord icon labeled “Power” will appear in the “Control Panel.” Choose “Advanced” in the Power Management Field.

Video Off Option (Suspend -> Off)

This field determines when to activate the video off feature for monitor power management. The settings are *Always On* and *Suspend -> Off*.

IV. BIOS SOFTWARE

Video Off Method (DPMS OFF)

This field defines the video off features. The following options are available: *DPMS OFF*, *DPMS Reduce ON*, *Blank Screen*, *V/H SYNC+Blank*, *DPMS Standby*, and *DPMS Suspend*. The DPMS (Display Power Management System) features allow the BIOS to control the video display card if it supports the DPMS feature. *Blank Screen* only blanks the screen (use this for monitors without power management or “green” features. If set up in your system, your screen saver will not display with *Blank Screen* selected). *V/H SYNC+Blank* blanks the screen and turns off vertical and horizontal scanning.

.....

PM Timers

This section controls the time-out settings for the Power Management scheme. The fields included in this section are “HDD Power Down”, which places the hard disk into its lowest power consumption mode, and the Doze, Standby and Suspend system inactivation modes.

The system automatically “wakes up” from any power saving mode when there is system activity such as when a key is pressed from the keyboard, or when there is activity detected from the enabled IRQ channels.

HDD Power Down (Disable)

Shuts down any IDE hard disk drives in the system after a period of inactivity. This time period is user-configurable to *1–15 Min* or *Disable*. This feature does not affect SCSI hard drives.

Suspend Mode (Disable)

Sets the period of time after which each of these modes activate: *1 Min*, *2 Min*, *4 Min*, *8 Min*, *10 Min*, *20 Min*, *30 Min*, *1 Hour*, *2 Hour*, and *4 Hour*.

.....

Power Up Control

This section determines the ways the system can be controlled when it is started or restarted, when modem activity is detected, or when power to the computer is interrupted and reapplied. The Soft-Off mode refers to powering off the system through a momentary button switch (ATX switch) or through the software as opposed to disconnecting the AC power by way of a rocker switch or other means.

PWR Button < 4 Secs (Soft Off)

When set to *Soft Off*, the ATX switch can be used as a normal system power-off button when pressed for less than 4 seconds. *Suspend* allows the button to have a dual function where pressing less than 4 seconds will place the system in sleep mode. *No Function* disables the ATX switch function when the button is pressed under 4 seconds. Regardless of the setting, holding the ATX switch for more than 4 seconds will power off the system.

IV. BIOS SOFTWARE

PWR Up On Modem Act (Enabled)

This allows either settings of *Enabled* or *Disabled* for powering up the computer (turns the ATX power supply on) when the modem receives a call while the computer is off. **NOTE:** The computer cannot receive or transmit data until the computer and applications are fully running, thus connection cannot be made on the first try. Turning an external modem off and then back on while the computer is off causes an initialization string that will also cause the system to power on.

AC PWR Loss Restart (Disabled)

This allows you to set whether you want your system to boot up after the power has been interrupted. *Disabled* leaves your system off after reapplying power and *Enabled* boots up your system after reapplying power.

Wake on LAN (Enabled)

Enable allows the ASUS PCI-L101 fast Ethernet card to power up the system using the proper software. *Disable* turns off this feature.

Automatic Power Up (Disabled)

This allows you to have an unattended or automatic power up of your system. You may configure your system to power up at a certain time of the day by selecting *Everyday*, which will allow you to set the time or at a certain time and day by selecting *By Date*.

.....

Fan Monitor (xxxxRPM)

The onboard hardware monitor is able to detect the Chassis Fan Speed, CPU Fan Speed, and the Power Supply Fan Speed in Rotations Per Minute (RPM). These values refresh upon any key entries in the BIOS setup screen. Set to *Ignore* if one of these are not used so that error messages will not be given.

.....

Thermal Monitor (xxxC/xxxF)

The onboard hardware monitor is able to detect the CPU (thermal-sensing heatsink required for Pentium II processor) and MB (motherboard) temperatures. These values refresh upon key entries. Set to *Ignore* if unavailable.

.....

Voltage Monitor (xx.xV)

The onboard hardware monitor is able to detect the voltages put out by the voltage regulators. These values refresh upon key entries. Set to *Ignore* if unavailable.

NOTE: If any of the monitored items are out of range, an error message will appear: "Hardware Monitor found an error, enter POWER MANAGEMENT SETUP for details". You will then be prompted to "Press **F1** to continue, **DEL** to enter SETUP".

IV. BIOS SOFTWARE

PNP and PCI Setup

This “PNP and PCI Setup” option configures the PCI bus slots. All PCI bus slots on the system use INTA#, thus all installed PCI cards must be set to this value.

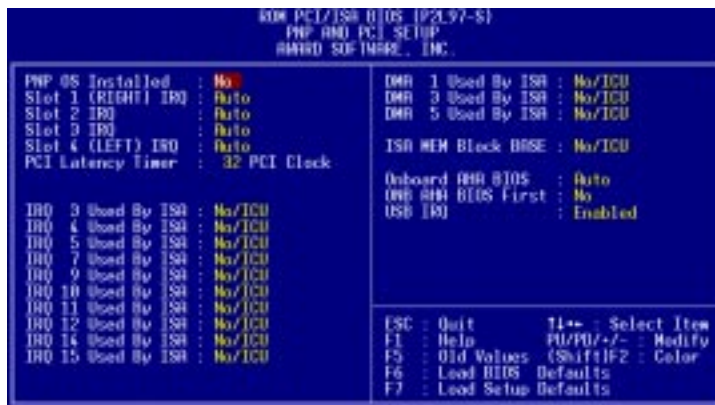

NOTE: SETUP Defaults are noted in parenthesis next to each function heading.

Details of PNP and PCI Setup

PNP OS Installed (No)

This field allows you to use a Plug-and-Play (PnP) operating system to configure the PCI bus slots instead of using the BIOS. Thus interrupts may be reassigned by the OS when *Yes* is selected. When a non-PnP OS is installed or to prevent reassigning of interrupt settings, select the default setting of *No*.

Slot 1 (RIGHT) IRQ to Slot 4/5 (LEFT) IRQ (Auto)

These fields set how IRQ use is determined for each PCI slot. The default setting for each field is *Auto*, which uses auto-routing to determine IRQ use. The other options are manual settings of *NA*, *5*, *7*, *9*, *10*, *11*, *12*, *14* or *15* for each slot.

PCI Latency Timer (32 PCI Clock)

The default setting of *32 PCI Clock* enables maximum PCI performance for this motherboard.

IRQ xx Used By ISA (No/ICU)

These fields indicate whether or not the displayed IRQ for each field is being used by a legacy (non-PnP) ISA card. Two options are available: *No/ICU* and *Yes*. The first option, the default value, indicates either that the displayed IRQ is not used or an ISA Configuration Utility (ICU) is being used to determine if an ISA card is using that IRQ. If you install a legacy ISA card that requires a unique IRQ, and you are not using an ICU, you must set the field for that IRQ to *Yes*. For example: If you install a legacy ISA card that requires IRQ 10, then set **IRQ10 Used By ISA** to *Yes*.

.....

IV. BIOS SOFTWARE

DMA x Used By ISA (No/ICU)

These fields indicate whether or not the displayed DMA channel for each field is being used by a legacy (non-PnP) ISA card. Available options include: *No/ICU* and *Yes*. The first option, the default setting, indicates either that the displayed DMA channel is not used or an ICU is being used to determine if an ISA card is using that channel. If you install a legacy ISA card that requires a unique DMA channel, and you are not using an ICU, you must set the field for that channel to *Yes*.

ISA MEM Block BASE (No/ICU)

This field allows you to set the base address and block size of a legacy ISA card that uses any memory segment within the C800H and DFFFH address range. If you have such a card, and you are not using an ICU to specify its address range, select a base address from the six available options; the **ISA MEM Block SIZE** field will then appear for selecting the block size. If you have more than one legacy ISA card in your system that requires to use this address range, you can increase the block size to either 8K, 16K, 36K, or 64K. If you are using an ICU to accomplish this task, leave **ISA MEM Block BASE** to its default setting of *No/ICU*.

Onboard AHA BIOS (Auto)

Auto enables the onboard Adaptec 7880 SCSI BIOS. If you do not want to use the onboard Adaptec 7880 SCSI BIOS, choose *Disabled*.

ONB AHA BIOS First (No)

This allows you to select whether you want the onboard SCSI to boot first by selecting *Yes* or for an external SCSI card to boot first by selecting *No*.

USB IRQ (Enabled)

Enabled reserves an IRQ# for the USB to work, *Disabled* does not allow the USB to have an IRQ# and therefore prevents the USB from functioning. If you do not use USB devices, you may *Disable* this feature to save an extra IRQ# for expansion cards.

IV. BIOS SOFTWARE

Load BIOS Defaults

This “Load BIOS Defaults” option allows you to load the troubleshooting default values permanently stored in the BIOS ROM. These default settings are non-optimal and disable all high performance features. To load these default settings, highlight “Load BIOS Defaults” on the main screen and then press <Enter>. The system displays a confirmation message on the screen. Press <Y> and then <Enter> to confirm. Press <N> and then <Enter> to abort. This feature does not affect the fields on the Standard CMOS Setup screen.

Load Setup Defaults

This “Load Setup Defaults” option allows you to load the default values to the system configuration fields. These default values are the optimized configuration settings for the system. To load these default values, highlight “Load Setup Defaults” on the main screen and then press <Enter>. The system displays a confirmation message on the screen. Press <Y> and then <Enter> to confirm. Press <N> and then <Enter> to abort. This feature does not affect the fields on the Standard CMOS Setup screen.



IV. BIOS SOFTWARE

Supervisor Password and User Password

These two options set the system passwords. “Supervisor Password” sets a password that will be used to protect the system and the Setup utility; “User Password” sets a password that will be used exclusively on the system. By default, the system comes without any passwords. To specify a password, highlight the type you want and then press <Enter>. A password prompt appears on the screen. Taking note that the password is case sensitive, and can be up to 8 alphanumeric characters long, type in your password and then press <Enter>. The system confirms your password by asking you to type it again. After setting a password, the screen automatically reverts to the main screen.



To implement password protection, specify in the “Security Option” field of the BIOS Features Setup screen when the system will prompt for the password. If you want to disable either password, press <Enter> instead of entering a new password when the “Enter Password” prompt appears. A message confirms the password has been disabled.

NOTE: If you forget the password, see **Clear Time Clock (Jumpers)** in section III for procedures on clearing the CMOS.

IV. BIOS SOFTWARE

IDE HDD Auto Detection

This “IDE HDD Auto Detection” option detects the parameters of an IDE hard disk drive, and automatically enters them into the Standard CMOS Setup screen.

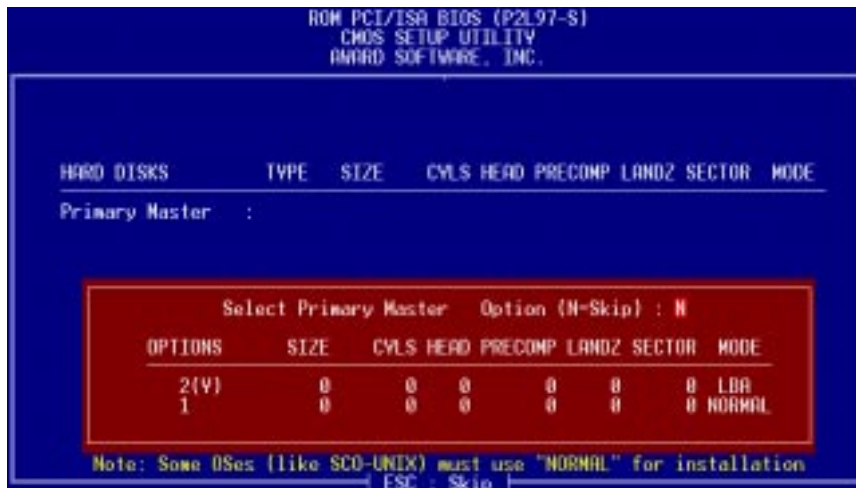

Up to four IDE drives can be detected, with parameters for each listed inside the box. To accept the optimal entries, press <Y> or else select from the numbers displayed under the OPTIONS field (2, 1, 3 in this case); to skip to the next drive, press <N>. If you accept the values, the parameters will appear listed beside the drive letter on the screen. The process then proceeds to the next drive letter. Pressing <N> to skip rather than to accept a set of parameters causes the program to enter zeros after that drive letter.

Remember that if you are using another IDE controller that does not feature Enhanced IDE support for four devices, you can only install two IDE hard disk drives. Your IDE controller must support the Enhanced IDE features in order to use Drive E and Drive F. The onboard PCI IDE controller supports Enhanced IDE, with two connectors for connecting up to four IDE devices. If you want to use another controller that supports four drives, you must disable the onboard IDE controller in the Chipset Features Setup screen.

When auto-detection is completed, the program automatically enters all entries you accepted on the field for that drive in the Standard CMOS Setup screen. Skipped entries are ignored and are not entered in the screen.

If you are auto-detecting a hard disk that supports the LBA mode, three lines will appear in the parameter box. Choose the line that lists LBA for an LBA drive. Do not select Large or Normal.

The auto-detection feature can only detect one set of parameters for a particular IDE hard drive. Some IDE drives can use more than one set. This is not a problem if the drive is new and empty.

IV. BIOS SOFTWARE

IMPORTANT: If your hard disk was already formatted on an older previous system, incorrect parameters may be detected. You will need to enter the correct parameters manually or use low-level format if you do not need the data stored on the hard disk.

If the parameters listed differ from the ones used when the disk was formatted, the disk will not be readable. If the auto-detected parameters do not match the ones that should be used for your disk, do not accept them. Press <N> to reject the presented settings and enter the correct ones manually from the Standard CMOS Setup screen.

Save & Exit Setup

Select this option to save into the CMOS memory all modifications you specified during the current session. To save the configuration changes, highlight the “Save & Exit Setup” option on the main screen, type “Y”, and then press <Enter>.



IV. BIOS
(Save & Exit)

Exit Without Saving

Select this option to exit the Setup utility without saving the modifications you specify during the current session. To exit without saving, highlight the “Exit Without Saving” option on the main screen and then press <Enter>.

V. DESKTOP MANAGEMENT

Desktop Management Interface (DMI)

Introducing the ASUS DMI Configuration Utility

This motherboard supports DMI within the BIOS level and provides a DMI Configuration Utility to maintain the Management Information Format Database (MIFD). DMI is able to auto-detect and record information pertinent to a computer's system such as the CPU type, CPU speed, and internal/external frequencies, and memory size. The onboard BIOS will detect as many system information as possible and store those collected information in a 4KB block in the motherboard's Flash EPROM and allow the DMI to retrieve data from this database. Unlike other BIOS software, the BIOS on this motherboard uses the same technology implemented for Plug and Play to allow dynamic real-time updating of DMI information versus creating a new BIOS image file and requiring the user to update the whole BIOS. This DMI Configuration Utility also allows the system integrator or end user to add additional information into the MIFD such as serial numbers, housing configurations, and vendor information. Those information not detected by the motherboard BIOS and has to be manually entered through the DMI Configuration Utility and updated into the MIFD. This DMI Configuration Utility provides the same reliability as PnP updating and will prevent the refreshing failures associated with updating the entire BIOS.

System Requirements

The DMI Configuration Utility (DMICFG2.EXE) must be used in real mode in order for the program to run, the base memory must be at least 180K. Memory managers like HIMEM.SYS (required by windows) must not be installed. You can boot up from a system diskette without AUTOEXEC.BAT and CONFIG.SYS files, "REM" HIMEM.SYS in the CONFIG.SYS, or press <F5> during bootup to bypass your AUTOEXEC.BAT and CONFIG.SYS files.

V. DESKTOP MANAGEMENT

Using the ASUS DMI Configuration Utility

Edit DMI (or delete)

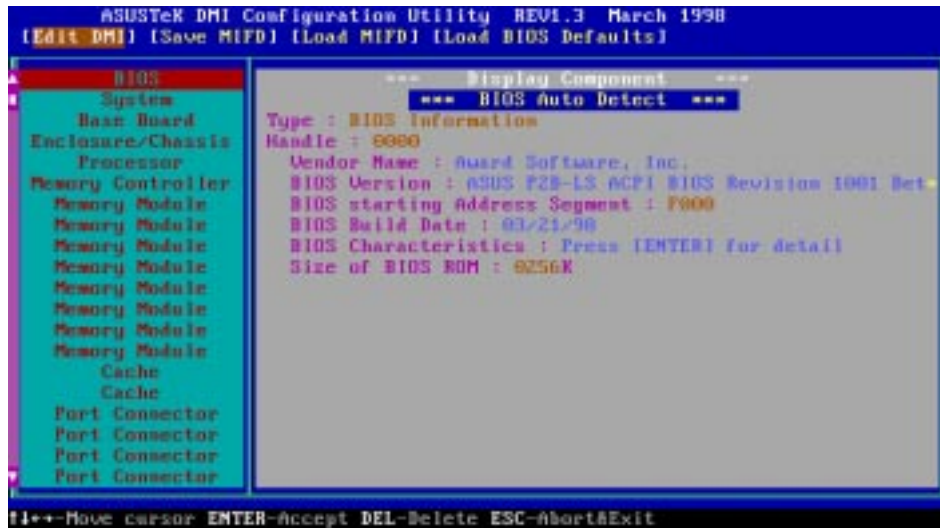

Use the ←→ (left-right) cursors to move the top menu items and the ↑↓ (up-down) cursor to move between the left hand menu items. The bottom of the screen will show the available keys for each screen. Press enter at the menu item to enter the right hand screen for editing. “Edit component” appears on top. The reversed color field is the current cursor position and the blue text are available for editing. The orange text shows auto-detected information and are not available for editing. The blue text “Press [ENTER] for detail” contains a second pop-up menu is available, use the + - (plus-minus) keys to change the settings. Enter to exit *and save*, ESC to exit *and not save*.

If the user has made changes, ESC will prompt you to answer Y or N. Enter Y to go back to the left-hand screen *and save*, enter N to go back to left-hand screen and *not save*. If editing has not been made, ESC will send you back to the left hand menu without any messages.

Notes

A heading, *** BIOS Auto Detect *** appears on the right for each menu item on the left side that has been auto detected by the system BIOS.

A heading, *** User Modified *** will appear on the right for menu items that has been modified by the user.



V. DESKTOP MANAGEMENT

Save MIFD



You can save the MIFD (normally only saved to flash ROM) to a file by entering the drive and path here. If you want to cancel save, you may press ESC and a message “Bad File Name” appears here to show it was not saved.

Load MIFD



You can load the disk file to memory by entering a drive and path and file name here.

Load BIOS Defaults



You can load the BIOS defaults from a MIFD file and can clear all user modified and added data. You must reboot your computer in order for the defaults to be saved back into the Flash BIOS.

VI. ADAPTEC SCSI SELECT

Configuring the SCSI Adapter

Access the SCSI BIOS by holding down both **CTRL** and **A** keys when you see the BIOS banner message listing the driver name and the attached devices. For example:

Adaptec AIC-7880 Ultra/Wide W BIOS v1.24
(c) 1996 Adaptec, Inc. All Rights Reserved.

<<< Press <Ctrl><A> for SCSISelect(TM) Utility! >>>

The SCSISelect screen will come up. Instructions on how to move the cursor and select options are listed on the bottom of the program windows. You can select either **Configure/View Host Adapter Settings** or **SCSI Disk Utilities**.

Configure/View Host Adapter Settings

Host Adapter SCSI Termination.....Low ON/High ON

- When using 50-Pin connector only, choose “Low ON/High ON” (Default)
- When using 68-Pin connector only, choose “Low ON/High ON” (Default)
- **When using both 50-Pin & 68-Pin, choose “Low OFF/High ON”**

Select the default of “Low ON/High ON” and press Enter, then use the up and down arrows to make your new selection and press Enter. Press ESC to go back to the Options menu. Press ESC again and select Yes to exit the program.

SCSI Disk Utilities

The SCSI Disk Utilities option displays information on SCSI IDs 0 through 15, listing all devices on the bus including non-disk devices. When you select a device from the list and press Enter key, another window appears giving you the option of selecting one of two sub-utilities, **Format Disk** or **Verify Media**. These utilities are used for hard disk drives only and will have no effect on other non-disk SCSI devices.

Format Disk - is a SCSI low-level formatting utility. In general, SCSI hard drive have already been low-level formatted when you get them, so you generally should not need to use this function.

Verify Media - scans the selected drive media for defects, notifies you of any found and gives you the option of reassigning bad blocks so that data will not be written to them. This is only necessary if you suspect that your SCSI disk drive has a problem.

(This page was intentionally left blank)

VII. ADAPTEC EZ-SCSI UTILITY

Welcome to Adaptec EZSCSI. ADAPTEC EZ-SCSI UTILITY 4.00e Adaptec EZSCSI gives you what you need to use your SCSI devices most effectively with Windows[®]95 and WindowsNT[™]. You can also use Adaptec EZSCSI on computers running DOS, Windows[®]3.1x, or Windows for Workgroups3.1x.

Quick Start Instructions

First, install SCSI devices (see the hardware documentation for details). Then follow the instructions for your operating system software in one of the following sections. We recommend that after you install Adaptec EZSCSI you run SCSTutor to learn more about the features of SCSI.

Windows95 or WindowsNT

If you want to install Windows95 or WindowsNT on a new computer system, you may not be able to access your SCSI CDROM drive at first. (Usually, you install Windows95 and WindowsNT from a CDROM disc.) To gain access to your CDROM drive, follow the DOS Quick Start instructions on page 4. Then reboot your computer and follow these instructions:

- 1 Install Windows95 or WindowsNT version 3.51 or above, and start it running on your computer.
- 2 Insert the Adaptec EZSCSI Setup Diskette in your floppy disk drive.
- 3 Click the Start button and select Run.
- 4 Type a:\setup if you are using the A drive or b:\setup if you are using the B drive. Then click OK.
- 5 Follow the instructions that appear on the screen.

Windows/Windows for Workgroups 3.1x

- 1 Install Windows3.1x or Windows for Workgroups3.1x and start it running on your computer.
- 2 Insert the Adaptec EZSCSI Setup Diskette in your floppy disk drive.
- 3 Select File/Run from the Program Manager menu.
- 4 When the Run dialog box appears, type a:\setup if you are using the A drive or b:\setup if you are using the B drive. Then click OK.
- 5 Follow the instructions that appear on the screen.

DOS

- 1 Install DOS6.x or above and start it running on your computer.
- 2 Insert the Adaptec EZSCSI Setup Diskette in your floppy disk drive.
- 3 At the DOS prompt, type a:\install (assuming your 3.5" floppy is A: drive). Then press Enter.
- 4 Follow the instructions that appear on the screen.

VII. ADAPTEC EZ-SCSI UTILITY

Troubleshooting Tips

SCSI Device Troubleshooting

Review this checklist if your newly-installed SCSI disk drives, CDROM drives, and other devices do not seem to work properly:

- Be sure that termination is correctly set for all devices on the SCSI bus, as described in your host adapter documentation.
- Be sure there are no hardware conflicts such as devices in your computer trying to use the same interrupts (IRQs) or DMA channels.
- Be sure the cables connecting the external and internal SCSI devices and the host adapter are attached securely. Also be sure the pin-1 orientation is correct for internal cables. See the host adapter documentation for more information.
- Be sure that each SCSI device connected to the host adapter has a unique SCSI ID.
- Be sure CD-ROM drives and other SCSI devices are attached to a power source and are turned ON.

Windows95/WindowsNT Troubleshooting

What is a miniport driver, and how do I make sure that the miniport driver is installed correctly?

Miniport drivers are a new kind of 32bit protect mode device driver used by Windows95 and WindowsNT to control host adapters and other kinds of devices. Windows95 and WindowsNT include a set of miniport drivers for various types of SCSI host adapters. The host adapter miniport driver is automatically installed and configured during Windows95 and WindowsNT installation if your host adapter is already installed. To make sure the driver is installed correctly in systems running Windows95, open the Control Panel, double-click on System, and click the Device Manager tab. Then double-click the SCSI Controllers icon; you should see the model name of the SCSI host adapter(s) installed in your system.

What if there is no SCSI controllers icon under Device Manager, or the model name of the SCSI chipset does not appear under Device Manager?

If the SCSI controllers icon or your host adapter's model name do not appear, open Control Panel and double-click the Add New Hardware icon. Let Windows search for the host adapter by selecting Yes on the second screen of the Add New Hardware Wizard.

If Windows does not detect the host adapter, run the Add New Hardware Wizard again. This time, select No on the second screen of the wizard, then select SCSI controllers on the next screen. Select the name of your host adapter when it appears.

VII. ADAPTEC EZ-SCSI UTILITY

If the name of your SCSI chipset does not appear, you may be able to find its miniport driver on the Windows95 CD-ROM. Follow these steps:

- 1 Place the Windows95 CD-ROM in your CDROM drive and run the Add New Hardware wizard.
- 2 Select No on the second screen, and select SCSI controllers on the next screen.
- 3 Click on the Have Disk button, then click the Browse button.
- 4 Look in the \drivers\storage directory of the CDROM and select the name of your SCSI host adapter if it appears.

What if a yellow exclamation point or a red X appears in Device Manager in front of my host adapter?

This means there is some kind of resource problem. First, see if the names of any host adapters appear that are not actually installed in your computer. If so, select the name and click Remove. If a red X appears in front of your host adapter name, remove all the host adapter references under SCSI Controllers and run Add New Hardware, as described in the previous question/answer. If a yellow exclamation point appears in front of your host adapter name, the resources that the driver uses probably do not match the resources used by the hardware. Double-click the host adapter name, then click on the Resource tab. Deselect the Use automatic settings box and edit the resources (Interrupt Request, Direct Memory Access, etc.) so they match those used by the host adapter. If the problem still remains, there is probably a hardware resource conflict between the host adapter and other hardware in your computer. You can fix this by changing the hardware resource settings. (See your hardware documentation.)

What do I need to do if I want to use another host adapter?

- 1 Open the Control Panel, double-click on System, and click the Device Manager tab.
- 2 Double-click the SCSI Controllers icon, select the name of the old host adapter, and click Remove.
- 3 Turn OFF the computer and physically remove the currently installed host adapter.
- 4 Install the new host adapter according to the instructions in the hardware documentation.
- 5 Turn the computer ON. If the new host adapter supports Plug and Play, Windows will install and configure it automatically. Otherwise, run Add New Hardware to make sure the new driver is loaded.

VII. ADAPTEC EZ-SCSI UTILITY

If I am running under Windows95, do I need lines for the Adaptec real mode ASPI drivers and mscdex in my config.sys and autoexec.bat files?

Usually, you do not need to use these real mode ASPI drivers, because the new Windows miniport drivers support most SCSI host adapters and SCSI devices. However, you need to load the drivers (including mscdex, if you have a CDROM drive) if any of the following is true:

- You are running in MSDOS mode
- You are using a scanner or another SCSI device with config.sys- or autoexec.bat-based drivers, such as HP's sjix.sys
- You have an older model SCSI-1 CDROM drive that Windows95 does not support
- You are using a CD-Recorder drive (however, some newer models of CD-Recorder drives can use the embedded Windows miniport drivers)

To install the Adaptec EZSCSI DOS drivers, click the Start button and select **Restart the computer in MS-DOS mode**. When the DOS prompt appears, follow the Quick Start instructions for DOS.

My CDROM drive doesn't work properly under Windows95.

Some older models of SCSI CDROM drives are not compatible with the embedded Windows95 CDROM driver. You can add support for the CDROM drive by doing the following:

- 1 Click the Start button and select Restart the computer in MS-DOS mode.
- 2 When the DOS prompt appears, follow the Quick Start instructions for DOS.
- 3 When you are finished running Adaptec EZSCSI for DOS, find the file named cdttd.vxd in the windows\system\iosubsys directory and rename it cdttd.sav.

My CDROM drive shows up as more than one icon under My Computer.

The mapping between mscdex, which runs in real mode, and the Windows95 CDROM driver does not match. You can correct this in one of two ways:

- Comment out the line that loads mscdex.exe in the autoexec.bat file.
- Change the /L switch on the line that loads mscdex.exe in the autoexec.bat file so it assigns the CDROM drive the next highest logical drive letter after the hard disk drives.

VII. ADAPTEC EZ-SCSI UTILITY

Information for DOS/Windows 3.1x Users

The following information may be useful if you install Adaptec EZSCSI on a computer running DOS, Windows 3.1x, or Windows for Workgroups 3.1x.

NOTE: The Windows95/WindowsNT Troubleshooting section on page 6 describes a few situations when you may need to use the DOS/Windows3.1x drivers and ASPI managers under Windows95 or WindowsNT.

DOS and Windows3.1x Device Drivers

Device drivers are software programs that enable your computer to communicate with SCSI devices such as hard disk drives, CDROM drives, and scanners. Each kind of device requires a different device driver. Adaptec EZSCSI includes several DOS/Windows3.1x device drivers that are copied to your hard disk during installation. Adaptec EZSCSI adds command lines to your config.sys and autoexec.bat files to load these device drivers if it finds these kinds of devices on your computer.

To learn more about the Adaptec EZSCSI device drivers, including their command line option information, see the online Adaptec EZSCSI Online Reference, a Windows Help application.

DOS and Windows3.1x ASPI Managers

ASPI (Advanced SCSI Programming Interface) managers are software programs that enable the SCSI device drivers, your host adapter, and your SCSI devices to communicate with each other. ASPI managers are written for a specific operating system, such as DOS, and a specific family of Adaptec host adapters.

Adaptec EZSCSI includes several ASPI managers for DOS/Windows3.1x. When you install Adaptec EZSCSI on these operating systems, it detects what kind of host adapter is installed in your computer and automatically configures your system with the correct ASPI manager. To learn more about these ASPI managers, including their command line option information, see the Adaptec EZSCSI Online Reference, a Windows Help application.

VII. ADAPTEC EZ-SCSI UTILITY

DOS Formatting Utilities

Adaptec EZSCSI includes several DOS-based formatting utilities:

Low-level Formatter (scsifmt)

Use the DOS-based scsifmt utility for low-level formatting of SCSI hard disk drives, removable media, Floptical[®] drives, and magneto-optical drives. You can also use it to scan a disk device for surface defects before you store data on it.

Run scsifmt from the DOS prompt, not from the Windows MSDOS prompt. Before you run it, be sure the disk devices you want to format are connected to the host adapter and that they are powered. Then follow these steps:

1. Change to the directory where scsifmt.exe is located (usually c:\scsi), type scsifmt at the DOS prompt, and press Enter.

NOTE: If you are formatting a SCSI disk device that supports more than one LUN (for example, Iomega's Bernoulli dual multidrive) type scsifmt / L at the command line.

2. When the first screen appears, read it and press Enter to continue. (Press F1 at any time to view Help.) Information about your SCSI disk devices appears on the screen.
3. Use the arrow keys to move the highlight bar to a disk device you want to format or verify, then press Enter.
4. When the next screen appears, select either Format or Verify (to verify that the disk is free of surface defects), then press Enter.

WARNING! Back up important data before you format the disk device!
A low-level format erases all data from the disk.

5. If you select Format, confirm that you want to format the disk, then wait while the disk device is formatted. This may take a long time if the disk is large.
If you select Verify, you can press Esc at any time to stop the verification process. (This does not damage the disk.) If the utility finds bad blocks on the disk, it displays information about them. You can reassign the bad block(s) to prevent data from being stored there.
6. Repeat steps 3, 4, and 5, as needed, to format or verify other disk devices. When you are finished, press Esc to exit.

VII. ADAPTEC EZ-SCSI UTILITY

Formatter and Partitioner (afdisk)

Use the DOS-based afdisk utility to partition and format SCSI hard disk drives, Floptical drives, and magneto-optical drives. You can also use afdisk to remove DOS and non-DOS partitions from a disk drive and to format removable media in standard hard disk format, OS/2 floppy format, or DOS V (Japanese) format.

NOTE: Use afdisk only if the disk device is not controlled by the host adapter BIOS—that is, if the host adapter does not have a BIOS or if its BIOS is not enabled. If the disk device is controlled by the host adapter BIOS, use the DOS fdisk utility to partition and format the disk device. (See the MSDOS documentation.)

Run afdisk from the DOS prompt only, not from the Windows MSDOS prompt. Before you run it, be sure the disk devices you want to format and partition are connected to the host adapter and that they are powered. Then follow these steps:

1. Change to the directory where afdisk.exe is located (usually c:\scsi), type afdisk at the DOS prompt, and press Enter.

Information about your SCSI disk devices appears on the screen. (The number that appears after Target is the device's SCSI ID.)

2. Use the arrow keys to move the highlight bar to the disk device you want to partition, then press Enter.
 - If the selected disk device is controlled by the host adapter BIOS, you can view information about it but you cannot partition it with afdisk (Use the DOS fdisk and format utilities.)
 - If the selected disk device is unpartitioned, you must partition it before you can format it. To do this, follow the instructions on the screen. (Press F1 to see an explanation of the partitioning options.)

Information about the selected disk device appears in the lower left of the screen. Disks smaller than 1Gigabyte have 64 heads, 32 sectors per track, and cylinders equal to the number of MBytes of available capacity. Disks larger than 1Gigabyte have 255 heads, 63sectors per track, and one cylinder per 8MBytes of available capacity.

VII. ADAPTEC EZ-SCSI UTILITY

3. To create a new partition on the disk device, press Ins. A screen similar to this appears:

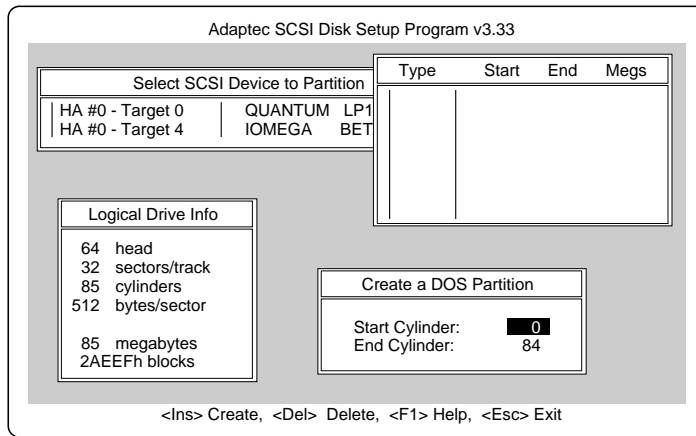

The Create a DOS Partition window suggests that you create one partition on the disk device, equal to its entire capacity. If this is what you want to do, skip to step 5.

4. To change the size of the partition, use the arrow keys to select Start Cylinder and End Cylinder, and type in the numbers you want. Partitions up to 2Gigabytes are supported.
5. When the number of cylinders is what you want, press Esc. When the confirmation prompt appears, select Yes and press Enter to create the partition. To create more partitions on the same disk device, repeat steps 3, 4, and 5. As you create partitions on the disk, they are added to the window at the upper right of the screen, as shown here:

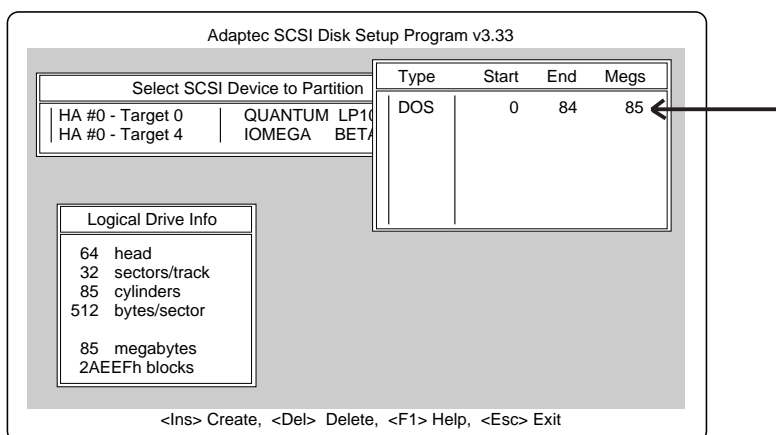

6. Press Esc to return to the Select SCSI Device to Partition window. If you want to partition a different disk device, select the device from the list and repeat the earlier steps.
7. To quit afdisk, press Esc and select Yes to confirm that you want to quit.