

TABLE OF CONTENTS

1. INTRODUCTION

1.1. PREFACE..... 1-1

1.2. KEY FEATURES 1-1

1.3. PERFORMANCE LIST..... 1-2

1.4. BLOCK DIAGRAM 1-3

1.5. INTRODUCE THE Pentium® II Processor 1-4

1.6. What is AGP? 1-6

2. SPECIFICATION

2.1. HARDWARE 2-1

2.2. SOFTWARE..... 2-2

2.3. ENVIRONMENT..... 2-2

3. HARDWARE INSTALLATION

3.1. UNPACKING 3-1

3.2. MAINBOARD LAYOUT 3-1

3.3. QUICK REFERENCE FOR JUMPERS & CONNECTORS 3-3

3.4. DRAM INSTALLATION..... 3-6

3.5. CPU SPEED SETUP 3-6

3.6. CMOS RTC & ISA CFG CMOS SRAM..... 3-7

3.7. SPEAKER CONNECTOR INSTALLATION 3-7

3.8. HARDWARE RESET SWITCH CONNECTOR INSTALLATION..... 3-7

3.9. POWER LED CONNECTOR INSTALLATION3-8

3.10. IDE & ATAPI DEVICE INSTALLATION.....3-8

3.11. PERIPHERAL DEVICE INSTALLATION.....3-8

3.12. KEYBOARD & PS/2 MOUSE INSTALLATION.....3-8

4. BIOS CONFIGURATION

4.1. ENTERING SETUP4-1

4.2. CONTROL KEYS4-1

4.3. GETTING HELP4-2

 4.3.1. Main Menu.....4-2

 4.3.2. Status Page Setup Menu / Option Page Setup Menu.....4-2

4.4. THE MAIN MENU.....4-2

4.5. STANDARD CMOS SETUP MENU4-4

4.6. BIOS FEATURES SETUP4-8

4.7. CHIPSET FEATURES SETUP4-13

4.8. POWER MANAGEMENT SETUP4-15

4.9. PNP/PCI CONFIGURATION4-19

4.10. LOAD BIOS DEFAULTS.....4-21

4.11. LOAD SETUP DEFAULTS4-22

4.12. INTEGRATED PERIPHERALS4-23

4.13. SUPERVISOR PASSWORD/USER PASSWORD4-28

4.14. IDE HDD AUTO DETECTION4-29

4.15. SAVE & EXIT SETUP4-30

4.16. EXIT WITHOUT SAVING4-31

1. INTRODUCTION

1.1. PREFACE

Welcome to use the **686LX3** motherboard. It is a Pentium® II Processor based PC / AT compatible system with AGP / PCI / ISA Bus, and has been designed to be the fastest PC / AT system. There are some new features allow you to operate the system with just the performance you want.

This manual also explains how to install the motherboard for operation, and how to set up your CMOS CONFIGURATION with BIOS SETUP program.

1.2. KEY FEATURES

- ❑ Intel Pentium® II Processor based PC / AT compatible mainboard.
- ❑ Slot 1 supports Pentium® II processor running at 200-633 MHz.
- ❑ Intel 440LX chipset, Supports AGP / SDRAM / Ultra DMA/33 IDE/ Keyboard and PS/2 Mouse Power On / ACPI features.
- ❑ Supports 3xDIMMs using 3.3V EDO or SDRAM DIMM module.
- ❑ Supports 8 MB - 768 MB EDO / 384MB SDRAM memory on board.
- ❑ Supports ECC or Non-ECC type DRAM module.
- ❑ 1xAGP slot, 4xPCI Bus slots, 3xISA Bus slots.
- ❑ Supports 2 channels Ultra DMA/33 IDE ports for 4 IDE Devices.
- ❑ Supports 2xCOM (16550), 1xLPT (EPP / ECP), 1x1.44MB Floppy port.
- ❑ Supports 2xUSB ports, 1xPS/2 Mouse.
- ❑ Licensed AWARD BIOS, 1Mbit FLASH RAM.
- ❑ 30.5 cm x 18 cm ATX SIZE form factor, 4 layers PCB.

1.3. PERFORMANCE LIST

The following performance data list is the testing results of some popular benchmark testing programs.

These data are just referred by users, and there is no responsibility for different testing data values gotten by users. (The different Hardware & Software configuration will result in different benchmark testing results.)

- CPU Pentium® II processor
- DRAM (32 x 2) MB SDRAM (LGS GM72V16821GT10K)
- CACHE SIZE 512 KB included in CPU
- DISPLAY GA-600 AGP Display Card (4MB SGRAM)
- STORAGE Onboard IDE (IBM DHEA-34330)
- O.S. Windows® 95 OSR2.1
- DRIVER Display Driver at 1024 x 768 x 64k colors at 75Hz.
TRIONES Bus Master IDE Driver 3.70

Processor	Intel Pentium® II	
	266MHz	300MHz
Winbench97		
CPU mark32	692	759
Business Disk	1940	2070
Hi-End Disk	5900	6210
Business Graphics	116	126
Hi-End Graphics	50.8	55.4
Winstone97		
Business	62.1	64.8
Hi-End	30.7	32.1

1.4. BLOCK DIAGRAM

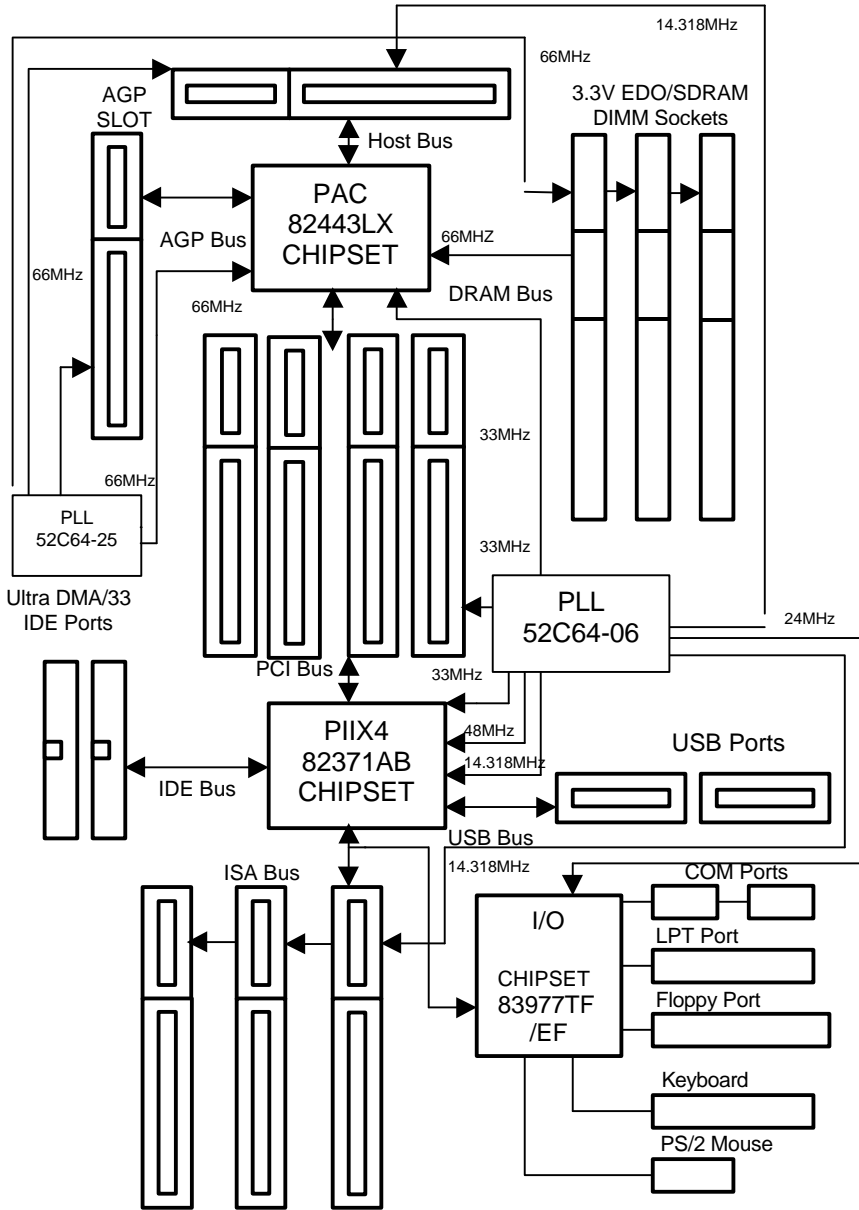

1.5. INTRODUCE THE Pentium® II Processor & AGP



Figure 1:Retention Mechanism & attach Mount



Figure 2:OEM Pentium® II Processor

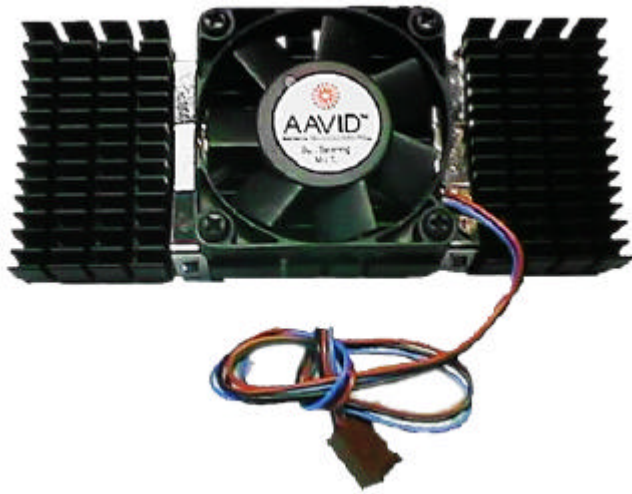

Figure 3:Heatsink / FAN & Heat sink support for OEM Pentium® II Processor

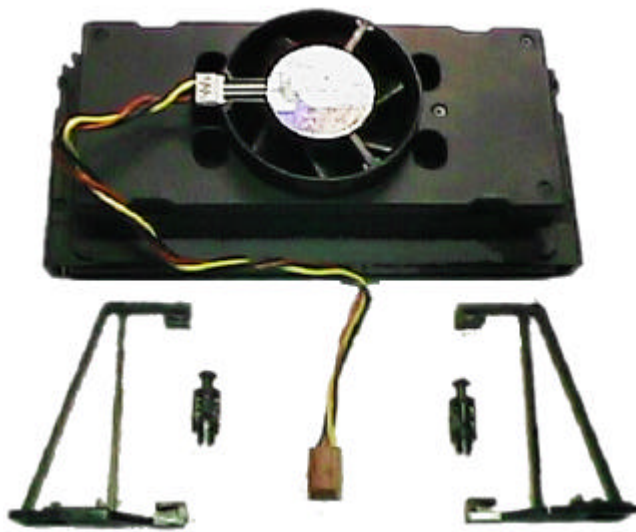

Figure 4:Boxed Pentium® II Processor & Heat sink support

1.6 What is AGP?

The Accelerated Graphics Port (AGP) is a new port on the Host-To-PCI bridge device that supports an AGP port. The main purpose of the AGP port is to provide fast access to system memory.

The AGP port can be used either as fast PCI port (32-bits at 66MHz vs. 32-bits at 33MHz) or as an AGP port which supports 2x data-rate, a read queue, and side band addressing. When the 2x-data rate is used, the port can transmit data at 533MB/sec ($66.6 \times 2 \times 4$). The read-queue can be used to pipeline reads – removing the effects of the reads-latency. Side band addressing can be used to transmit the data address on a separate line in order to speed up the transaction.

2. SPECIFICATION

2.1. HARDWARE

- CPU
 - Pentium® II processor 200 – 633 MHz.
 - 242 pins 66MHz slot1 on board.
- SPEED
 - 66 MHz system speed.
 - 66 MHz AGP bus speed. (133MHz 2X mode)
 - 33 MHz PCI-Bus speed.
 - 8 MHz AT bus speed.
- DRAM MEMORY
 - 3 banks 168 pins DIMM module sockets on board.
 - Use 8 / 16 / 32 / 64 / 128 / 256 MB DIMM module DRAM.
 - 8 ~ 768 MB EDO / 384 MB SDRAM.
 - Supports 3.3V SDRAM / EDO type DRAM.
 - Supports ECC or Non-ECC type DRAM.
- CACHE MEMORY
 - 32 KB 1st cache memory included in CPU.
 - 256KB/512 KB 2nd cache in CPU.
 - Supports DIB speed mode for L2 Cache.
- I/O BUS SLOTS
 - 4 33MHz Master / Slave PCI-BUS.
 - 3 8MHz 16 bits ISA BUS.
 - 1 66MHz / 133MHz AGP bus.
- IDE PORTS
 - 2 Ultra DMA/33 Bus Master IDE channels on board.(Using IRQ14,15)
 - Support Mode 3,4 IDE & ATAPI CD – ROM.
- I/O PORTS
 - Supports 2 16550 COM ports.
 - Supports 1 EPP/ECP LPT port.
 - Supports 1 1.44/2.88 MB Floppy port.
 - Supports 2 USB ports.
 - Supports PS/2 Mouse.

- GREEN FUNCTION
 - Suspend mode support.
 - Green switch & ACPI LED support.
 - IDE & Display power down support.
 - Monitor all IRQ / DMA / Display / I/O events.
- BIOS
 - 2M bits FLASH RAM.
 - Supports Plug & Play, DMI, ACPI Function.
- DIMENSION
 - ATX Form Factor, 4 layers PCB.

2.2. SOFTWARE

- DRIVER
 - Bus Master IDE Driver.
 - Suspend to HD utility.
 - Patch_95.
- BIOS
 - Licensed AWARD BIOS.
 - AT CMOS Setup, BIOS / Chipset Setup, Green Setup, Hard Disk Utility included.
- O.S.
 - Operation with MS-DOS[®], Windows[®]95, WINDOWS[™] NT, OS/2, NOVELL and SCO UNIX.

2.3. ENVIRONMENT

- Ambient Temp.
 - 0°C to +50°C (Operating).
- Relative Hum.
 - 0 to +85% (Operating).
- Altitude
 - 0 to 10,000 feet (Operating).
- Vibration
 - 0 to 1,000 Hz.
- Electricity
 - 4.9 V to 5.2 V. (Max. 20A current at 5V.)

3. HARDWARE INSTALLATION

3.1. UNPACKING

The mainboard package should contain the following:

- The **686LX3** mainboard.
- The Retention Mechanism & Attach Mount
- USER'S MANUAL for mainboard.
- Cable set for IDE, Floppy devices.
- Diskette or CD for Mainboard Utility.

The main board contains sensitive electric components, which can be easily damaged by static electricity, so the mainboard should be left in its original packing until it is installed.

Unpacking and installation should be done on a grounded anti-static mat. The operator should be wearing an anti static wristband, grounded at the same point as the anti-static mat.

Inspect the mainboard carton for obvious damage. Shipping and handling may cause damage to your board. Be sure there are no shipping and handling damages on the board before proceeding.

After opening the mainboard carton, extract the system board and place it only on a grounded anti-static surface component side up. Again inspect the board for damage. Press down on all of the socket IC's to make sure that they are properly seated. Do this only on with the board placed on a firm flat surface.

● **DO NOT APPLY POWER TO THE BOARD IF IT HAS BEEN DAMAGED.**

3.2. MAINBOARD LAYOUT

PCB Ver : 2.0

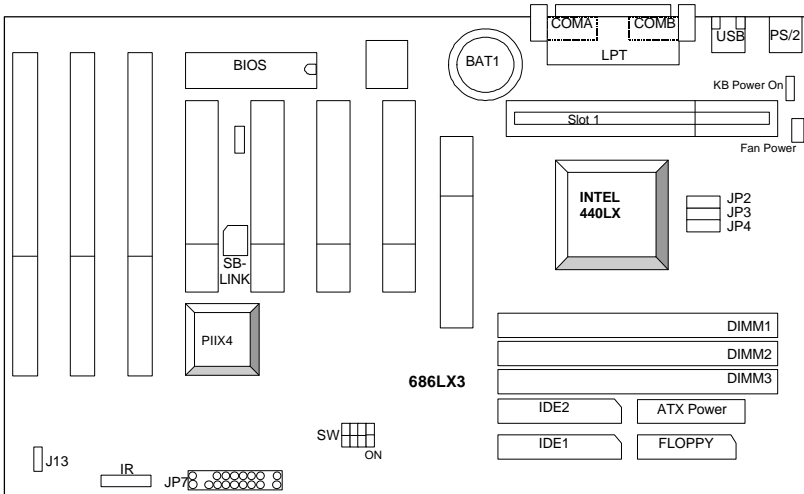

<Figure 3.1>

PCB Ver : 2.2

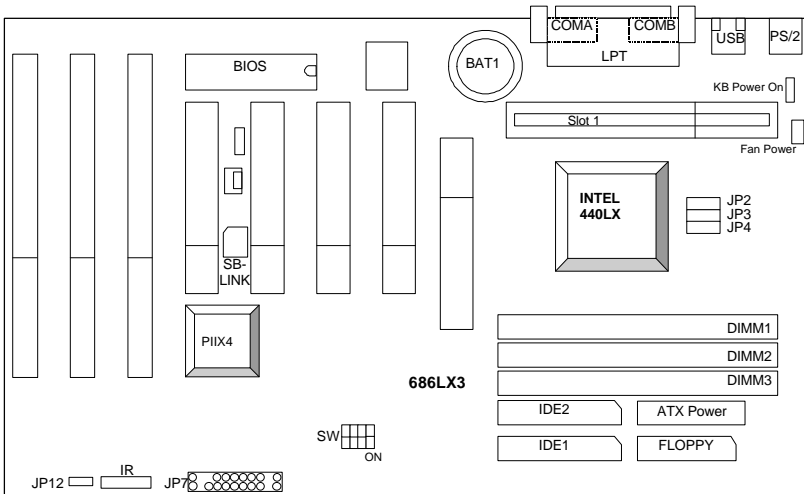

<Figure 3.2>

3.3. QUICK REFERENCE FOR JUMPERS & CONNECTORS

◆ I/O Ports Connector	
USB	USB port.
IDE1	For Primary IDE port.
IDE2	For Secondary IDE port.
PS/2	For PS/2 Keyboard port.
PS/2	For PS/2 Mouse port.
Floppy	For Floppy port
COMB	For Serial port2 (COM B).
COMA	For Serial port1 (COM A).
LPT	For LPT port.

◆ Slot 1
For Pentium® II processor installed

◆ FAN PWR : CPU cooling FAN Power Connector	
Pin No.	Function
1	GND.
2	+12V
3	SENSE

◆ J13 : System After Ac Back	
Pin No.	Function
1	Signal
2	GND

◆ JP1 : Keyboard Power On Selection	
Pin No.	Function
1-2	Enabled Keyboard power on.
2-3	Disabled Keyboard power on.

◆ JP10 : Wake on LAN Connector	
Pin No.	Function
1	+5VSB
2	GND
3	CTRL-Signal

◆ J6 :RING POWER ON	
Pin No.	Function
1	Signal
2	GND

◆ JP12 : CLEAR CMOS Function	
Pin No.	Function
1-2	CLEAR CMOS Function
2-3	NORMAL

◆ SB-LINK : For PCI Sound Card Connector	
Pin No.	Function
1	Signal
2	GND
3	NC
4	Signal
5	GND
6	Signal

◆ INFRARED Connector (IR) -- Function Optional	
Pin No.	Function
1	IR Data Output
2	GND
3	IR Data Input
4	NC
5	POWER (+)

JP7 : 2*11 PIN Jumper

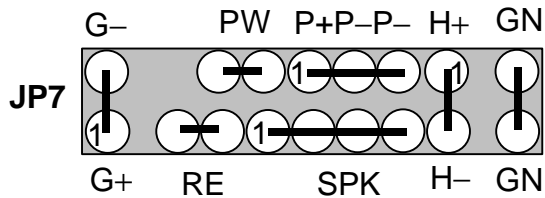

PW: Soft Power Connector



Open: Normal Operation

Short: Power On/Off

RE: Reset Switch



Open: Normal Operation
Short: For Hardware Reset System

P+P- P- : Power LED

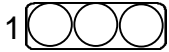

PIN 1 : anode (+)
PIN 2 : cathode (-)
PIN 3 : cathode (-)

SPK: Speaker Connector

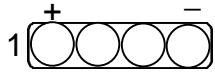

PIN 1 : VCC
PIN 2 : NC
PIN 3 : NC
PIN 4 : Data

H+H- : IDE Hard Disk Active LED



PIN 1: LED anode (+)
PIN 2: LED cathode (-)

GN: Green Function Switch



Open : Normal operation
Short : Entering Green Mode

G- G+: Green LED



PIN 1 : LED anode (+)
PIN 2 : LED cathode (-)

3.4. DRAM INSTALLATION

The mainboard can be installed with 8 / 16 / 32 / 64 / 128 / 256 MB 168 pins DIMM module DRAM, and the DRAM speed must be 50 or 60 ns for EDO & 67~100 MHz for SDRAM. The DRAM memory system on mainboard consists of bank 0, 1 & bank 2.

Since 168 pins DIMM module is 64 bits width, using 1 PCS which can match a 64 bits system. The total memory size is 8 MB ~ 768 MB EDO / 384MB SDRAM. The DRAM installation position refer to Figure 3.1, and notice the Pin 1 of DIMM module must match with the Pin 1 of DIMM socket. Insert the DRAM DIMM module into the DIMM socket at Vertical angle. If there is a wrong direction of Pin 1, the DRAM DIMM module couldn't be inserted into socket completely.

3.5. CPU SPEED SETUP

The default system bus speed is 66MHz. The user can change the DIP SWITCH (**SW**) selection to set up the CPU speed for 200 - 366MHz processor. The CPU speed must match with the frequency RATIO and external clock frequency. It will cause system hanging up if the frequency RATIO and external clock frequency are higher than that of CPU.

DIP SWITCH (SW)				FREQ. RATIO	EXT.CLK. MHz	INT.CLK. MHz	CPU Type
1	2	3	4				
ON	OFF	ON	ON	3	66	200	Pentium® II 200 MHz
OFF	OFF	ON	ON	3.5	66	233	Pentium® II 233 MHz
ON	ON	OFF	ON	4	66	266	Pentium® II 266 MHz
OFF	ON	OFF	ON	4.5	66	300	Pentium® II 300 MHz
ON	OFF	OFF	ON	5	66	333	Pentium® II 333 MHz
OFF	OFF	OFF	ON	5.5	66	366	Pentium® II 366 MHz

Main Clock	JP4	JP3	JP2
66 MHz	1-2	1-2	1-2
75 MHz	1-2	2-3	1-2
83 MHz	2-3	1-2	2-3
100 MHz	1-2	2-3	2-3

- ⚠ We don't recommend you to setup your system speed to 75, 83 or 100MHz because these frequencies are not the standard specifications for CPU, Chipset and most of the peripherals. Whether your system can run under 75, 83 or 100MHz properly will depend on your hardware configurations: CPU, SDRAM, Cards, etc.
- ⚠ The CPU is a sensitive electric component and it can be easily damaged by static electricity, so users must keep it away from metal surface when the CPU is installed onto mainboard.

3.6. CMOS RTC & ISA CFG CMOS SRAM

The main board contains RTC & CMOS SRAM on board. They have a power supply from external battery to keep the DATA inviolate & effective. The RTC is a REAL-TIME CLOCK device, which provides the DATE & TIME to system. The CMOS SRAM is used for keeping the information of system configuration, so the system can automatically boot OS every time. Since the lifetime of internal battery is 5 years, the user can change a new Battery to replace old one when it has consumed.

- ⚠ Danger of explosion if battery is incorrectly replaced.
- ⚠ Replace only with the same or equivalent type recommended by the manufacturer.
- ⚠ Dispose of used batteries according to the manufacturer's instructions.

3.7. SPEAKER CONNECTOR INSTALLATION

There is a speaker in AT system for sound purpose. The 4 - Pins connector **SPK** is used to connect speaker. Anode connects +, Cathode connects -.

3.8. HARDWARE RESET SWITCH CONNECTOR INSTALLATION

The RESET switch on panel provides users with HARDWARE RESET function. The system will do a cold start after the RESET switch is pushed and released by user. The RESET switch is a 2 PINS connector and should be installed to

RE on mainboard.

3.9. POWER LED CONNECTOR INSTALLATION

System has power LED lamp on the panel of case. The power LED will light on off or flash to indicate which step on the system. The connector should be connected to **P+P-P-** of mainboard in correct direction.

3.10. IDE & ATAPI DEVICE INSTALLATION

There are two-Enhanced PCI IDE ports (**IDE1, IDE2**) on board, which following ATAPI standard SPEC. Any one IDE port can connected to two ATAPI devices (IDE Hard Disk, CD-ROM & Tape Driver), so total four ATAPI devices can exist in a system. The **HD** is the active LED port for ATAPI devices.

3.11. PERIPHERAL DEVICE INSTALLATION

After the I/O device installation and jumpers setup, the mainboard can be mounted into the case and fixed by screw. To complete the mainboard installation, the peripheral device could be installed now. The basic system needs a display interface card. If the PCI - Bus device is to be installed in the system, any one of four PCI - Bus slots can be used.

3.12. KEYBOARD & PS/2 MOUSE INSTALLATION

The main board supports PS/2 Mouse (**J2**). The BIOS will auto detect whether the PS/2 Mouse is installed or not & assign IRQ12 for PS/2 Mouse port if it is installed. After installing the peripheral device, the user should check everything again, and prepare to power-on the system.