

TRADEMARKS

Award
is a registered trademark of Award Software, Inc.

Pentium CPU
is a registered trademark of Intel Corp.

PCI-bus
is a registered trademark of PCI Special Interest Group.

UM8890
is a registered trademark of United Microelectronics Corp.

All other brand and product names are trademarks or registered trademarks of their respective companies.

TABLE OF CONTENTS

PREFACE v

Chapter 1 INTRODUCTION..... 1-1

 Specifications 1-1

 Features 1-2

Chapter 2 SYSTEM COMPONENTS..... 2-1

 CPU..... 2-2

 CPU Installation 2-2

 Chipset 2-3

 ROM BIOS 2-4

 System DRAM 2-4

 Cache SRAM 2-5

Chapter 3 CONNECTORS AND JUMPERS..... 3-1

 Connector Definition 3-2

 Jumper Definition..... 3-3

Chapter 4 MEMORY CONFIGURATION 4-1

 System DRAM 4-2

 DRAM Configuration 4-2

 DRAM Installation 4-3

 Cache SRAM 4-4

 Cache Configuration 4-4

Cache Installation	4-4
Memory Mapping	4-6
Memory Address	4-7
I/O Mapping	4-7

Chapter 5 AWARD BIOS SETUP 5-1

STANDARD CMOS SETUP	5-3
Date / Time	5-3
Primary/Secondary Master/Slave	5-4
Drive A / B	5-4
Video	5-4
Halt On	5-4
BIOS FEATURES SETUP	5-5
Virus Warning	5-6
CPU Internal Cache	5-6
External Cache	5-6
Quick Power On Self Test	5-6
Boot Sequence	5-6
Swap Floppy Drive	5-7
Boot Up Floppy Seek	5-7
Boot Up NumLock Status	5-7
Boot Up System Speed	5-7
IDE HDD Block Mode	5-7
Gate A20 Option	5-8
Memory Parity Check	5-8
Typematic Rate Setting	5-8
Typematic Rate	5-8
Typematic Delay	5-9
Security Option	5-9
IDE Second Channel Control	5-9
Video or System ROM Shadow	5-9

CHIPSET FEATURES SETUP	5-10
POWER MANAGEMENT SETUP	5-11
Power Management	5-12
PM Control By APM	5-13
Video Off Method	5-13
HDD Standby Timer	5-13
Doze Timer Select	5-13
Standby Timer Select	5-14
Inactive Timer Select	5-15
Doze Mode	5-15
Standby Mode	5-15
Inactive Mode	5-16
*Monitor Event In Full On Mode items	5-16
PCI/GREEN FUNCTION SETUP	5-17
*Wakeup Event In Suspend Mode	5-17
LOAD BIOS DEFAULTS	5-18
LOAD SETUP DEFAULTS	5-18
PASSWORD SETTING	5-18
IDE HDD AUTO DETECT	5-19
EXITING SETUP	5-19

PREFACE

This manual contains basic information necessary for both the end user and service personnel. Although most of the information you need are contained in this manual, we recommend you to contact an authorized dealer for service purposes. Making personal alterations to the system can violate the effectivity of your warranty.

The manual is divided into five chapters.

- Chapter 1** lists the motherboard specifications and features.
- Chapter 2** describes the functions of the major system components.
- Chapter 3** provides the jumper and connector definitions.
- Chapter 4** contains the memory configuration information.
- Chapter 5** explains how you can configure your system by running the SETUP program.

CAUTION TEXTS CONCERNING LITHIUM BATTERIES

DANISH

ADVARSEL!

Lithiumbatteri - Eksplosionsfare ved fejlagtig håndtering. Udskiftning må kun ske med batteri af samme fabrikat og type. Levér det brugte batteri tilbage til leverandøren.

NORWEGIAN

ADVARSEL:

Lithiumbatteri - Eksplosjonsfare. Ved utskifting benyttes kun batteri som anbefalt av apparatfabrikanten. Brukt batteri returneres apparatleverandøren.

SWEDISH

VARNING:

Explosionsfara vid felaktigt batteribyte. Använd samma batterityp eller en ekvivalent typ som rekommenderas av apparattillverkaren. Kassera använt batteri enligt fabrikantens instruktion.

FINNISH

VAROITUS:

Paristo voi räjähtää, jos se on virheellisesti asennettu. Vaihda paristo ainoastaan laitevalmistajan suosittelemaan tyyppiin. Hävitä käytetty paristo valmistajan ohjeiden mukaisesti.

ENGLISH

CAUTION:

Danger of explosion if battery is incorrectly replaced. Replace only with the same or equivalent type recommended by the equipment manufacturer. Discard used batteries according to manufacturer's instructions.

DEUTSCH

VORSICHT:

Explosionsgefahr bei unsachgemäßem Austausch der Batterie. Ersatz nur durch denselben oder einen vom Hersteller empfohlenen gleich-wertigen Typ. Entsorgung gebrauchter Batterien nach Angaben des Herstellers.

Chapter 1

INTRODUCTION

■ Specifications

- One ZIF socket for Intel Pentium CPU
- UM8890 chipset
- Four 72-pin SIMM sockets configurable up to 256MB
- 256KB, 512KB, or 1MB cache memory
- 128KB Award ROM BIOS
- Expansion slots:
 - four ISA slots
 - three PCI-bus slots
- I/O support
 - one parallel port with ECP/EPP
 - two serial ports with 16550 - for high speed modem
 - two PCI-IDE connectors for four IDE devices
 - one FDD connector

■ Features

- Host/bridge PCI-bus architecture
- Fully compatible with IBM PC/AT
- Write-back / write-through cache technology
- Advanced power-saving modes:
 - Doze mode
 - Standby mode
 - Inactive mode

Chapter 2

SYSTEM COMPONENTS

This section describes the major components of the motherboard.

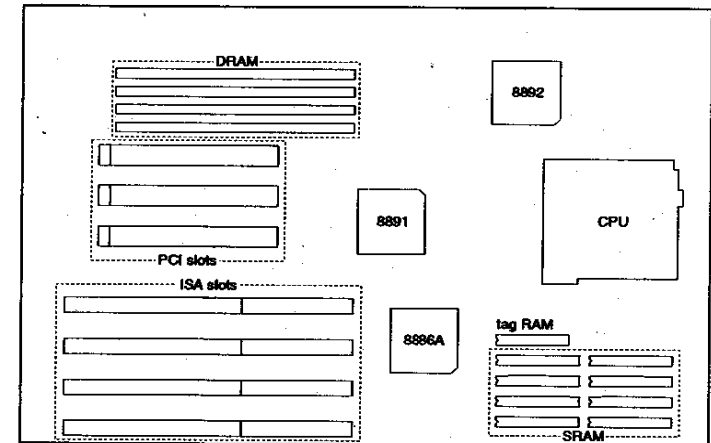

Motherboard revision number: R02

■ CPU

The CPU is a 64-bit microprocessor chip that forms the basis of the high-performance system with 16KB internal cache memory on chip.

CPU Installation

NOTE:

Static electricity can destroy electronic devices. Whenever you handle any option outside of its protective packaging, first discharge any static electricity from your body by touching a protective grounding device or unpainted metal on the rear panel of the system unit.

To install CPU in a ZIF socket:

1. Find the ZIF socket on the motherboard. (See p.2-1.)
2. Lift the ZIF socket arm up to the vertical position.
3. Align the CPU so its Pin 1 corner (beveled corner) is at the Pin 1 corner of the ZIF socket. Then insert the CPU's pins into the corresponding holes in the socket.

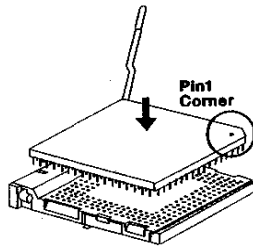

4. Press the arm downwards to the horizontal position. You will feel some resistance while doing so. This is normal as the pressure starts to secure the CPU in place.

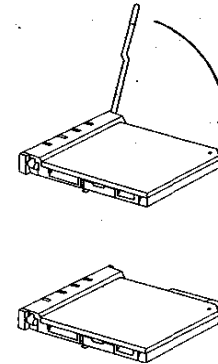

5. Set JP7 according to the CPU speed. (See p.3-3.)

■ Chipset

The UM8890 chipset is comprised of UM8891 (host bridge / cache memory controller), UM8892 (data path controller with write buffer), and UM8886A (ISA bridge and system I/O).

- Supports the Pentium processor at 60MHz and 66MHz
- Interface the host buses to the Peripheral Component Interconnect (PCI) local bus operating at 30MHz or 33.3MHz up to 132MB/sec transfer rate
- Full concurrence between CPU host bus and PCI bus transactions
- Integrated cache controller provided for optional second level cache

- Provides 64-bit DRAM interface
- Supports the pipeline address mode of Pentium processor for higher performance
- Supports concurrence between CPU host bus and PCI bus transactions
- Supports burst read and write of memory from the host and PCI buses
- Integrated post write buffers and read prefetch buffers increase CPU and PCI master performance
- Byte parity supports for main memory buses
- Package and technology
 - UM8891 208PQFP, 0.6um CMOS
 - UM8892 208PQFP, 0.6um CMOS
 - UM8886A 208PQFP, 0.6um CMOS

■ ROM BIOS

The BIOS holds the fundamental functions and acts as a communication channel between the motherboard and the rest of the system. You can configure the motherboard through the SETUP program. Details regarding the ROM BIOS are thoroughly discussed in Chapter 5.

■ System DRAM

There are four SIMM sockets. Each can support 256KB, 512KB, 1MB, 2MB, 4MB, 8MB, 16MB, and 32MB SIMM module. Refer to Chapter 4 for DRAM configuration and installation.

■ Cache SRAM

The effectiveness of the cache is determined predominantly by the size and organization of the cache. The motherboard design allows you to configure the external cache for 256KB, 512KB, or 1MB. It uses the write-back / write-through cache algorithm to minimize access time to the main memory, which improves overall system performance. Refer to Chapter 4 for proper SRAM configuration and installation.

Chapter 3

CONNECTORS AND JUMPERS

This chapter defines the connectors and jumpers on the motherboard. The figure below shows the connector and jumper positions.

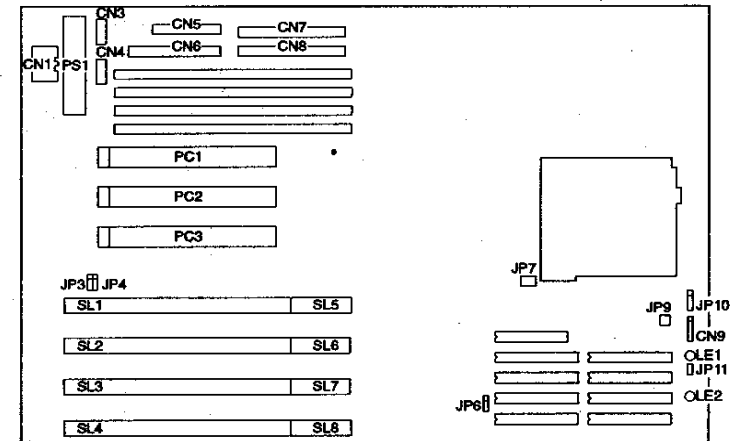

■ Connector Definition

Connector	Function
CN1	keyboard
CN3	COM1
CN4	COM2
CN5	PRINTER
CN6	FDD
CN7	SECONDARY IDE
CN8	PRIMARY IDE
CN9	keylock / power LED
JP10	speaker
JP11	reset
JP12	turbo
LE1	HDD LED
LE2	turbo LED
PS1	power
PC1-PC3	PCI slots
SL1-SL8	ISA slots

■ Jumper Definition

Jumpers are used to select options for certain features. To set a jumper to "close" means covering the jumper pins with the jumper caps, and "open" means not to cover the pins. Jumpers with more than two pins have numbers on the motherboard identifying the pins.

i. Intel

JP	75MHz CPU	90MHz CPU	100MHz CPU	120MHz CPU	133MHz CPU	150MHz CPU	166MHz CPU
JP3 (DRQ)	2-3	2-3	2-3	2-3	2-3	2-3	2-3
JP4 (DACK)	2-3	2-3	2-3	2-3	2-3	2-3	2-3
JP7 (Frequency)	1-2	3-4	1-2,5-6	3-4	1-2,5-6	3-4	1-2,5-6
JP8 (RATIO)	open	open	open	3-4	3-4	1-2,3-4	1-2,3-4
JP9 (Cache) - 256KB - 512KB - 1MB	open 1-2 1-2,3-4	open 1-2 1-2,3-4	open 1-2 1-2,3-4	open 1-2 1-2,3-4	open 1-2 1-2,3-4	open 1-2 1-2,3-4	open 1-2 1-2,3-4
JP20 (Voltage) - STD/VR - VRE	2-3 1-2	2-3 1-2	2-3 1-2	2-3 1-2	2-3 1-2	2-3 1-2	2-3 1-2

ii. Cyrix

JP	80MHz CPU	100MHz CPU	120MHz CPU
JP3 (DRQ)	2-3	2-3	2-3
JP4 (DACK)	2-3	2-3	2-3
JP7 (Frequency)	3-4,5-6	1-2	3-4
JP8 (RATIO)	3-4	3-4	3-4
JP9 (Cache) - 256KB - 512KB - 1MB	open 1-2 1-2,3-4	open 1-2 1-2,3-4	open 1-2 1-2,3-4
JP20 (Voltage) - STD/VR - VRE	2-3 n/a	2-3 n/a	2-3 n/a

Chapter 4

MEMORY CONFIGURATION

This chapter tells you how to configure the system DRAM and cache SRAM. The figure below shows the DRAM and SRAM locations:

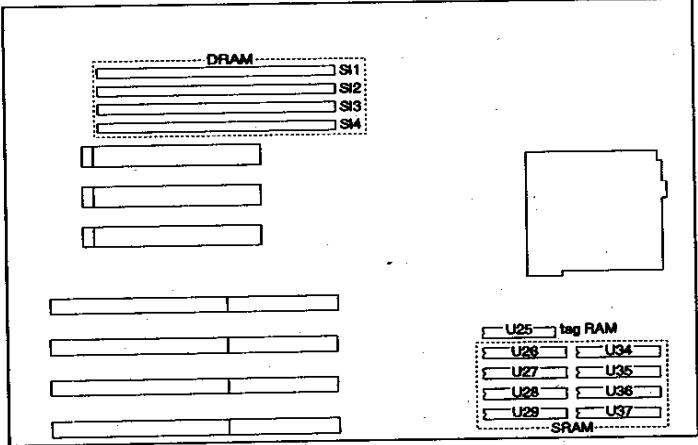

■ System DRAM

DRAM Configuration

Bank 1 (SIMM1, 2)		Bank 2 (SIMM3, 4)		Total
256KB x 32	256KB x 32	--	--	2MB
--	--	256KB x 32	256KB x 32	2MB
256KB x 32	256KB x 32	256KB x 32	256KB x 32	4MB
512KB x 32*	512KB x 32*	--	--	4MB
--	--	512KB x 32*	512KB x 32*	4MB
512KB x 32*	512KB x 32*	512KB x 32*	512KB x 32*	8MB
1MB x 32	1MB x 32	--	--	8MB
--	--	1MB x 32	1MB x 32	8MB
1MB x 32	1MB x 32	1MB x 32	1MB x 32	16MB
2MB x 32*	2MB x 32*	--	--	16MB
--	--	2MB x 32*	2MB x 32*	16MB
2MB x 32*	2MB x 32*	2MB x 32*	2MB x 32*	32MB
4MB x 32	4MB x 32	--	--	32MB
--	--	4MB x 32	4MB x 32	32MB
4MB x 32	4MB x 32	4MB x 32	4MB x 32	64MB
8MB x 32*	8MB x 32*	--	--	64MB
--	--	8MB x 32*	8MB x 32*	64MB
8MB x 32*	8MB x 32*	8MB x 32*	8MB x 32*	128MB
16MB x 32	16MB x 32	--	--	128MB
--	--	16MB x 32	16MB x 32	128MB
16MB x 32	16MB x 32	16MB x 32	16MB x 32	256MB
32MB x 32*	32MB x 32*	--	--	256MB
--	--	32MB x 32*	32MB x 32*	256MB

* means dual-bank DRAM.

NOTE:

Use DRAM chips of the same speed (≤ 70 ns) throughout the system to avoid memory problems.

DRAM Installation

NOTE:

Static electricity can destroy electronic devices. Whenever you handle any option outside of its protective packaging, first discharge any static electricity from your body by touching a protective grounding device or unpainted metal on the rear panel of the system unit.

1. Locate the DRAM sockets on the motherboard. (See the figure on p.4-1.)
2. Align the SIMM's notched end with the sockets corresponding end and firmly insert the SIMM into the socket at an angle. Maintaining this angle, insert the SIMM all the way into the slot. Then, push the SIMM towards the plastic clips to snap it into place.

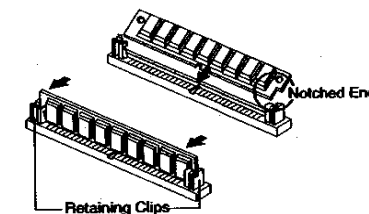

Cache SRAM

The motherboard provides options for configuring the external cache SRAM to either 256KB, 512KB, or 1MB.

Cache Configuration

Cache	Tag (U25)	SRAM (U26~29, U34~37)
256KB	32KB x 8	32KB x 8 (MIX MODE)
512KB	32KB x 8	64KB x 8 (MIX MODE)
1MB	32KB x 8	128KB x 8 (MIX MODE)

NOTE:

Use chips of the same speed (15ns) throughout the system to avoid memory problems.

Cache Installation

NOTE:

Static electricity can destroy electronic devices. Whenever you handle any option outside of its protective packaging, first discharge any static electricity from your body by touching a protective grounding device or unpainted metal on the rear panel of the system unit.

1. Locate the SRAM sockets. (See the figure on p.4-1.)

2. The two rows of pins are probably splayed too far apart and must be angled closer together before installation.

Rest the side of the chip on a hard and even surface. Carefully and steadily push down the chip until the pins are at a right angle with the chip body. Repeat for the other side.

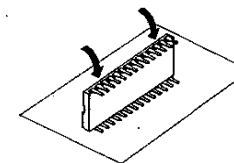

3. Align the notch end of the chip with the notch end of the socket. Then insert the chip's pins into the corresponding holes in the socket.

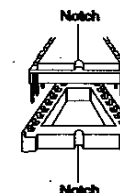

4. See the jumpers (JP9) according to the cache size. (See p.3-3.)

■ Memory Mapping

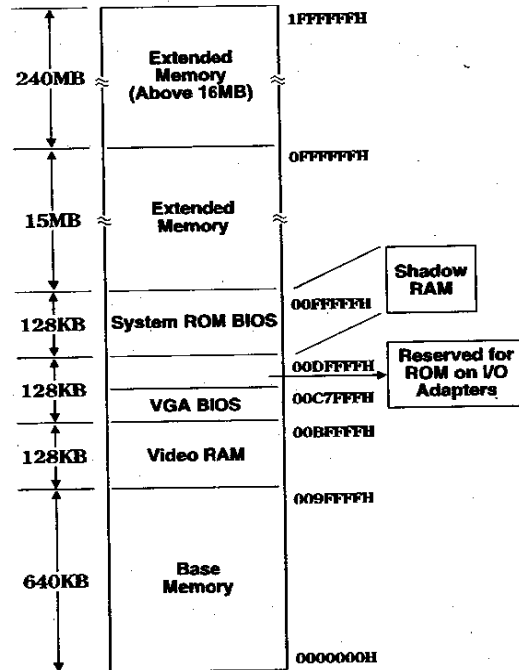

■ Memory Address

Hex Address	Device
00000000 - 0009FFFF	basic memory
000A0000 - 000BFFFF	video memory
000C0000 - 000C7FFF	VGA BIOS
000C8000 - 000DFFFF	reserved for ROM on I/O adapters
000E0000 - 000FFFFFFF	system ROM BIOS or shadow RAM
00100000 - 01FFFFFF	extended memory

■ I/O Mapping

Hex Address	Device
0000 - 001F	DMA controller 1
0020 - 003F	interrupt controller 1 and chipset programmable register
0040 - 005F	timer
0060 - 006F	keyboard controller
0070 - 007F	real time clock, NMI mask
0080 - 009F	DMA page register
00A0 - 00BF	interrupt controller 2
00C0 - 00DF	DMA controller 2
00F0	clear numeric coprocessor busy
00F1	reset numeric coprocessor
00F8 - 00FF	numeric coprocessor
0100 - 3FF	adapter I/O

Chapter 5

AWARD BIOS SETUP

The SETUP program contains a record of the computer's system parameters (such as, amount of memory, disk drives, video displays, numeric coprocessors, etc.) in the CMOS. When the computer is turned off, a back-up battery retains the system parameters in the CMOS memory.

To enter SETUP, power on the computer and press **DEL** immediately.

The following is the SETUP main menu:

STANDARD CMOS SETUP	PASSWORD SETTING
BIOS FEATURES SETUP	IDE HDD AUTO DETECTION
CHIPSET FEATURES SETUP	SAVE & EXIT SETUP
POWER MANAGEMENT SETUP	EXIT WITHOUT SAVING
PCI/GREEN FUNCTION SETUP	
LOAD BIOS DEFAULTS	
LOAD SETUP DEFAULTS	

SETUP Options

The following is the best way to set up the system. From the main menu:

1. Select the STANDARD CMOS SETUP option and choose the device types.
2. Select the LOAD SETUP DEFAULTS option, and follow the on-screen instructions.

Below are the generic keys for the BIOS SETUP program:

Key	Function
Esc	1. Quit without saving. 2. Exit to main menu.
←→↑↓	Moves the cursor to a desired item.
+ / - PgUp PgDn	Modifies the value of the highlighted item.
F1	Displays the help screen of a selected item.
F2 Shift-F2	Changes the colors.
F5	Loads all items in the BIOS FEATURES SETUP / CHIPSET FEATURES SETUP with the old values before the current SETUP was started.
F6	Loads all items in the BIOS FEATURES SETUP / CHIPSET FEATURES SETUP with the BIOS defaults.
F7	Loads all items in the BIOS FEATURES SETUP / CHIPSET FEATURES SETUP with the SETUP defaults.

■ STANDARD CMOS SETUP

STANDARD CMOS SETUP is the first option on the main SETUP menu. Move the highlight bar to this option and press ENTER to select it. The items for this option are:

Date (mm:dd:yy)	: Mon, Feb. 6 1995
Time (hh:mm:ss)	: 10 : 36 : 12
HARD DISKS	: TYPE
Primary Master	: None
Primary Slave	: None
Secondary Master	: None
Secondary Slave	: None
Drive A	: 1.44 MB, 3.5 in.
Drive B	: None
Video	: EGA / VGA
Halt On	: All Errors

Items of STANDARD CMOS SETUP

Date / Time

The first item in the Standard CMOS SETUP screen is the current date setting. A calendar has been provided to facilitate its setting. Press PgUp or PgDn to select the appropriate value for the month, date, and year.

The procedure for setting the time is similar to that of setting the date. Note that the time has a 24-hour format.

Primary/Secondary Master/Slave

This item sets the hard disk type.

There are 46 pre-defined types of hard disk drives. For an unknown type, choose *User* (user definable). *None* applies to diskless workstations and SCSI hard disks.

Drive A/ B

This item sets the floppy disk drive type. It can support the following drive types: 5.25 in. (360K and 1.2M) or 3.5 in. (720K, 1.44M, and 2.88M).

Video

This item sets the type of video adapter installed. The available options are:

EGA / VGA (default)
CGA 40
CGA 80
MONO

Halt On

This item determines whether the computer will stop if an error is detected during power up.

The available options are:

All Errors (default)
No Errors
All, But Keyboard
All, But Diskette
All, But Disk/key

BIOS FEATURES SETUP

The BIOS FEATURES SETUP program is equipped with a series of help screens. Press F1 for help screens.

Virus Warning	: Disabled
CPU Internal Cache	: Enabled
External Cache	: Enabled
Quick Power On Self Test	: Enabled
Boot Sequence	: A, C
Swap Floppy Drive	: Disabled
Boot Up Floppy Seek	: Enabled
Boot Up NumLock Status	: On
Boot Up System Speed	: High
IDE HDD Block Mode	: Disabled
Gate A20 Option	: Fast
Memory Parity Check	: Enabled
Typematic Rate Setting	: Disabled
Typematic Rate (Chars/Sec)	: 6
Typematic Delay (msec)	: 250
Security Option	: Setup
IDE Second Channel Control	: Enabled
Video BIOS Shadow	: Enabled
C8000-CBFFF Shadow	: Disabled
CC000-CFFFF Shadow	: Disabled
D0000-D3FFF Shadow	: Disabled
D4000-D7FFF Shadow	: Disabled
D8000-DBFFF Shadow	: Disabled
DC000-DFFFF Shadow	: Disabled

Items of BIOS FEATURES SETUP

Virus Warning

If this item is set to *Enabled*, during and after the system boots up, any attempt to write to the boot sector or partition table of the hard disk drive will halt the system and the following error message will appear. In the mean time, you can run an anti-virus program to locate the problem.

!WARNING!
Disk boot sector is to be modified
Type **Y** to accept write or **N** to abort write

The default setting is *Disabled*.

CPU Internal Cache

This item allows you to use the internal cache on the CPU. The available options are *Enabled* (default) and *Disabled*.

External Cache

This item allows you to use the external cache. The available options are *Enabled* (default) and *Disabled*.

Quick Power On Self Test

This item speeds up Power On Self Test (POST) after you power on the computer. The default for this item is *Enabled* which allows BIOS to shorten or skip some check items during POST.

Boot Sequence

The default for this item is *A,C*. The system first boots from floppy drive A and then from drive C. To interchange the sequence, set this item to *C, A*.

Swap Floppy Drive

This feature allows you to exchange the drive names of the two floppy disk drives. It works if your system has two floppy disk drives defined in this SETUP program. Make sure that Drive A/B item of STANDARD CMOS SETUP option has been updated.

The available options are:

Disabled (default)
Enabled

Boot Up Floppy Seek

The default for this item is *Enabled*. If it is set to *Disabled*, BIOS will not search for floppy disk drive to determine if it is 40 or 80 tracks.

Boot Up NumLock Status

At default, the Num Lock is *On* at system boot. Setting it to *OFF* turns the NumLock off.

Boot Up System Speed

This item selects the default system speed - the speed that system will run at immediately after power up. The available options are:

High (default)
Low

IDE HDD Block Mode

This item enables or disables the IDE HDD Block Mode. The default setting is *Disabled*.

Gate A20 Option

This item uses the fast gate A20 line to access any memory above 1MB. Setting this item to make the access faster than the normal method. The default setting is *Fast*.

Memory Parity Check

This item enables or disables the memory parity checking. Recommended setting for this item is *Enabled*.

Typematic Rate Setting

This item adjusts the *Typematic Delay* and *Typematic Rate* whenever a keystroke is repeated.

Typematic Rate (Chars/Sec)

This item controls the rate at which a character is repeated (in chars/sec) whenever a key is held down. The available options are:

6(default)
8
10
12
15
20
24
30

Typematic Delay (msec)

This item controls the delay time (in msec) when a key is pressed and held down. The available options are:

250 (default)
500
750
1000

Security Option

This feature allows the password to prevent unauthorized system boot-up or unauthorized use of BIOS SETUP. Options for this item are *SETUP* and *System*. At default (*SETUP*), the password prompt appears only when you want to enter the SETUP program.

If set to *System*, each time you want to boot the system or to run SETUP, the prompt for user password appears.

NOTE:

To disable security, select *PASSWORD SETTING* option from the main menu, and press *ENTER* when you are asked to enter a password.

IDE Second Channel Control

This item enables or disables the IDE second channel. The default setting is *Enabled*.

Video or System ROM Shadow

When enabled, this feature allows the BIOS code to be copied from slower ROM to faster RAM. Each option allows for a segment of 16KB to be shadowed from ROM to RAM. If one of these options is enabled, and there is BIOS present in that particular 16KB segment, the BIOS will be shadowed.

■ CHIPSET FEATURES SETUP

This section of the BIOS SETUP is used to change the values for the chipset registers. These registers control most of the system options on the motherboard.

Auto Configuration	: Enabled
DRAM Read Wait states	: 1 WS
DRAM Write Wait states	: 1 WS
DRAM RAS# Precharge Time	: 4 clocks
DRAM RAS# Low to CAS# low	: 3 clocks
DRAM Page Mode Option	: Disabled
L2 Cache Update Scheme	: Wr-Back
Tag Option	: 7+1 Bit
Cache Read Wait States	: 0 WS
Cache Write Wait States	: 0 WS
Cache Tag Hit Wait States	: 0 WS
System BIOS cacheable	: Disabled
Video BIOS Cacheable	: Disabled
Keyboard Controller Clock	: PCICLK/3
ISA Bus Clock Option	: PCICLK/3
Keyboard Emulation	: Disabled
CPU Pipeline Function	: Enabled
CPU To PCI Write Buffer	: Enabled
PCI Bus Park Option	: Enabled
PCI Posted Memory Write	: Disabled
HOST Clock / PCI Clock	: 1 : 1/2
Preempt PCI Mater Option	: Enabled
IBC DEVEL# Decoding	: Slow
Onboard FDC Controller	: Enabled
Onboard Parallel Mode	: ECP Mode
Onboard Parallel Port	: 378H
Onboard Serial Port 1	: COM1
Onboard Serial Port 2	: COM2

Items of CHIPSET FEATURES SETUP

NOTE:

You are suggested not to change the settings of the CHIPSET FEATURES SETUP items.

■ POWER MANAGEMENT SETUP

Power Management allows you to conserve power for your system.

Power Management	: User Defined	
PM Control By APM	: Enabled	
Video Off Method	: DPMS Support	
HDD Standby Timer	: 15 Min	
Doze Timer Select	: 0.25 Min	
Standby Timer Select	: 2 Min	
Inactive Timer Select	: 2 Min	
Mode Control	CPU Speed	Display
Doze Mode	: 1/4 HCLK	Turn On
Standby Mode	: 1/8 HCLK	Turn Off
Inactive Mode	: STOP CLK	
* Monitor Event In Full On Mode		
PCI Master2 Check	: Enabled	
PCI Master1 Check	: Enabled	
PCI Master0 Check	: Enabled	
VESA Slave Access Check	: Disabled	
LPT Access Check	: Enabled	
COM Access Check	: Enabled	
ISA Master & DMA Check	: Enabled	
IDE Access Check	: Enabled	
Floppy Access Check	: Enabled	
VGA Access Check	: Disabled	
Keyboard Access Check	: Enabled	

Items of POWER MANAGEMENT SETUP

Power Management

This item is the master control for the Power Management features. The available options are:

User Defined (default)
Disabled
Min Saving
Max Saving
Optimized

Below are the descriptions of the four options:

Option	Description
Disabled	The Power Management feature does not take effect.
Min Saving	Some items are pre-defined for the Power Management to assumedly save minimum power. The pre-defined settings are: HDD Standby Timer: 15 Min Doze Timer Select: 512 Min Standby Timer Select: 512 Min Inactive Timer Select: 512 Min
Max Saving	Some items are pre-defined for the Power Management to assumedly save maximum power. The pre-defined settings are: HDD Standby Timer: 1 Min Doze Timer Select: 0.5 Min Standby Timer Select: 2 Min Inactive Timer Select: 2 Min
Optimized	Some items are pre-defined for the Power Management to assumedly save power with high system performance. The pre-defined settings are: HDD Standby Timer: Disabled Doze Timer Select: 512 Min Standby Timer Select: 512 Min Inactive Timer Select: 512 Min
User Defined	All the settings can be defined for the Power Management to work in the way as specified by the user.

PM Control By APM

The default for this item is *Enabled* which activates the APM (Advanced Power Management) driver.

Video Off Method

This item lets you define the monitor status in Inactive mode. The available options are:

DPMS Support (default)
Blank Screen
V/H SYNC + Blank

HDD Standby Timer

Setting the HDD Standby Timer causes the hard disk to cease spinning if it is not in use during the set time-out period. The available options are:

1 Min 2 Min 3 Min 4 Min 5 Min
 6 Min 7 Min 8 Min 9 Min 10 Min
 11 Min 12 Min 13 Min 14 Min 15 Min (default)
Disabled

Doze Timer Select

Setting the Doze Timer Select allows your system to enter Doze mode when no major device activities have occurred during the set time-out period. (Major devices refer to the keyboard, mouse, FDD, hard disk and SIO/PIO.) The available options are:

0.25 Min (default)
 0.5 Min 1 Min 2 Min 4 Min 8 Min
 16 Min 32 Min 64 Min 128 Min 256 Min
 512 Min

While in Doze mode,

- The CPU speeds can be *1/2, 1/4, 1/6 or 1/8 CLKI*. (The speed is determined by the Doze Mode item under Mode Control.)
- The screen can be *On* (default) or *Off*.

The system will wake up from Doze mode if it detects any major device activities.

Standby Timer Select

Setting the Standby Timer Select allows your system to enter Standby mode when no major device activities have occurred during the set time-out period. (Major devices refer to the keyboard, mouse, FDD, hard disk and SIO/PIO.) The available options are:

2 Min (default)	4 Min	8 Min
16 Min	32 Min	64 Min
128 Min	256 Min	512 Min

While in Standby mode,

- The CPU speeds can be *1/2, 1/4, 1/6 or 1/8 CLKI*. (The speed is determined by the Standby Mode item under Mode Control.)
- The screen can be *On* or *Off* (default).

The system will wake up from Standby mode if it detects any major device activities.

Inactive Timer Select

Setting the Inactive Timer Select allows your system to enter Inactive mode when no major device activities have occurred during the set time-out period. (Major devices refer to the keyboard, mouse, FDD, hard disk and PIO/SIO.) The available options are:

2 Min (default)	4 Min	8 Min
16 Min	32 Min	64 Min
128 Min	256 MIN	512 Min

While in Inactive mode,

- The CPU halts (*STOP CLK*) or speeds down (*1/8 CLKI*). (The speed is determined by the Inactive Mode item under Mode Control.)
- The screen blanks out.

The system will wake up from Inactive mode if it detects any major device activities.

Doze Mode

This item controls the CPU speed in Doze Mode. The available options are:

<i>1/2 CLKI</i>	<i>1/4 CLKI</i> (default)
<i>1/6 CLKI</i>	<i>1/8 CLKI</i>

Standby Mode

This item controls the CPU speed in Standby Mode. The available options are:

<i>1/2 CLKI</i>	<i>1/4 CLKI</i>
<i>1/6 CLKI</i>	<i>1/8 CLKI</i> (default)

Inactive Mode

This item controls the CPU speed in Inactive Mode. The available options are:

STOP CLK (default)
1/8 CLKI

***Monitor Event In Full On Mode items**

You are suggested to set most of the items to *Enabled* so the Power Management can monitor the major device activities to assure optimal operation.

■ PCI/GREEN FUNCTION SETUP

Slot 1 Using INT#	:	AUTO
Slot 2 Using INT#	:	AUTO
Slot 3 Using INT#	:	AUTO
1st Available IRQ	:	10
2nd Available IRQ	:	9
3rd Available IRQ	:	11
PCI IRQ Activated By	:	Level
PCI IDE Controller	:	Enabled
* WakeUp Event In Inactive Mode		
Monitor IRQ3 Wake Up	:	Enabled
Monitor IRQ4 Wake Up	:	Enabled
Monitor IRQ5 Wake Up	:	Enabled
Monitor IRQ6 Wake Up	:	Enabled
Monitor IRQ7 Wake Up	:	Enabled
Monitor IRQ9 Wake Up	:	Enabled
Monitor IRQ10 Wake Up	:	Enabled
Monitor IRQ11 Wake Up	:	Enabled
Monitor IRQ12 Wake Up	:	Enabled
Monitor IRQ14 Wake Up	:	Enabled
Monitor IRQ15 Wake Up	:	Enabled

Items of PCI/GREEN FUNCTION SETUP

The PCI SETUP program provides the *plug & play* function, which automatically sets the IRQ channel, the memory address and the I/O address for your system.

***Wakeup Event In Suspend Mode items**

These items let you select the event which will wake up the system from the Suspend mode. You are suggested to set them to *Enabled*.

■ LOAD BIOS DEFAULTS

The BIOS default values have been set to provide the minimum performance for the system.

To use the BIOS defaults, simply type **Y** and press **ENTER**.

■ LOAD SETUP DEFAULTS

The SETUP default values have been set to provide the maximum performance for the system.

To use the SETUP defaults, simply type **Y** and press **ENTER**.

■ PASSWORD SETTING

The PASSWORD SETTING feature is used to change the user password of your system.

To change the user password, move the cursor to this option and press **ENTER**. The following prompt appears:

Enter Password:

Press **ENTER** if you do not want to set a password.

After the new password is entered, you will be asked to confirm or re-enter the new password.

NOTE:

The password feature described here will depend on the configuration of the Security Option described in the BIOS FEATURES SETUP. If you select System, you will be prompted for the password every time the system is rebooted or any time you try to enter SETUP. If you select Setup, you will be prompted only when you try to enter SETUP.

■ IDE HDD AUTO DETECT

The IDE HDD AUTO DETECT feature automatically selects disk type for your newly installed hard disk.

■ EXITING SETUP

To exit the SETUP program, you can choose **SAVE & EXIT SETUP** or **EXIT WITHOUT SAVING** from the main SETUP menu.