

6KF

**82440 LX PCI Mainboard
User's Guide &
Technical Reference**



SOYOTM

About This Guide

This User's Guide is for assisting system manufacturers and end users in setting up and installing the mainboard. Information in this guide has been carefully checked for reliability; however, no guarantee is given as to the correctness of the contents. The information in this document is subject to change without notice.

Copyright Notice

Copyright 1997, Soyo Computer Inc. All rights reserved. This manual is copyrighted by Soyo Computer Inc. You may not reproduce, transmit, transcribe, store in a retrieval system, or translate into any language, in any form or by any means, electronic, mechanical, magnetic, optical, chemical, manual, or otherwise, any part of this publication without express written permission of Soyo Computer Inc.

Trademarks

Soyo is a registered trademark of Soyo Computer Inc. All trademarks are the property of their owners.

Disclaimer

Soyo Computer Inc. makes no representations or warranties regarding the contents of this manual. We reserve the right to revise the manual or make changes in the specifications of the product described within it at any time without notice and without obligation to notify any person of such revision or change. The information contained in this manual is provided for general use by our customers. Our customers should be aware that the personal computer field is the subject of many patents. Our customers should ensure that they take appropriate action so that their use of our products does not infringe upon any patents. It is the policy of Soyo Computer Inc. to respect the valid patent rights of third parties and not to infringe upon or assist others to infringe upon such rights.

Restricted Rights Legend

Use, duplication, or disclosure by the Government is subject to restrictions set forth in subparagraph (c)(1)(ii) of the Rights in Technical Data and Computer Software clause at 252.277-7013.

Product Rights

Product mentioned in this manual are mentioned for identification purpose only. Product names appearing in this manual may or may not be registered trademarks or copyrights of their respective companies.

If you need any further information, please come to our home page on internet. The address is "<http://www.soyo.com.tw>".

Edition: November 1997

Version 1.0

6KF SERIAL

FC Tested To Comply
With FCC Standards
FOR HOME OR OFFICE USE

Table of Contents

Chapter 1: Introduction	1
Key Features	1
Unpacking the Mainboard	2
Electrostatic Discharge Precautions	2
Mainboard Layout w/ Default Settings	3
Chapter 2: Hardware Setup	5
Jumpers	5
JP3: CMOS Clear Jumper	5
JP12/JP15/JP16: Power Supply Selection Jumper	6
JP6/JP7/JP11: CE Test Jumper Pin	6
SW1: Bus Fraction Core/Bus Ratio Select Jumper	6
CPU Type Configuration	7
686 (PII) – 233 CPU Settings (3.5 x clock)	7
686 (PII) – 266 CPU Settings (4.0 x clock)	7
686 (PII) – 300 CPU Settings (4.5 x clock)	8
686 (PII) – 330 CPU Settings (5.0 x clock)	8
Memory Configuration	8
Multi I/O Port Addresses	9
Connectors	9
AT PW — Power Supply Connectors	9
ATX PW — ATX Power Supply Connectors	9
J8 — PS/2 Keyboard Connector	10
IR — IR Connector	10
Keylock — Keylock & Power LED Connector	10
SPEAKER — Speaker Connector	11
RESET — Hardware Reset Control	11
IDE1/IDE2 — On-board Primary/Secondary IDE HDD Connectors	11
COM1/COM2 Connectors	11
HDD LED — IDE HDD LED Connectors	11
FDC Connector	11
PRT — Parallel Port Connector	11
USB (J3) — (Universal Serial Bus) Connector	11
PW/SW — ATX Power Supply On/Off Switch Connector (Momentary Type)	11
TB LED — Turbo LED Connector	12
FAN (JP10) — CPU Cooling Fan Connector	12
JP9 — Wake-On-LAN (WOL) Header	12
Slot 1 Installation Guide	13

Chapter 3: BIOS Setup	19
Standard CMOS Setup	20
BIOS Features Setup	22
Chipset Features Setup	25
Power Management Setup	28
PNP/PCI Configuration Setup	31
Load Setup Defaults	32
Load BIOS Defaults	33
Integrated Peripherals	33
Supervisor Password	35
User Password	36
IDE HDD Auto Detection	37
Quick Installation Guide	38
Motherboard Layout	38
CPU Jumper Settings	38
Memory Configurations	39
Connectors and Jumper Settings	39
Default I/O Settings	39

1 Introduction

The 82440 LX PCI mainboard is a high-performance AT architecture system board that supports 686 (PII) family CPUs. This mainboard is fully compatible with industry standards, and adds many technical enhancements.

Key Features

- Processor supports:
 - Pentium II CPU up to 66 MHz host bus frequency (233 ~ 333 MHz)
 - **auto detection of CPU voltage**
 - **Slot 1 support**
- DRAM controller:
 - **supports 3 strips of 168-pin EDO /SDRAM Unbuffered DIMM**
 - supports auto detection of memory type
 - **supports ECC or Parity configuration**
 - has onboard memory configurations from 8MB to 384MB
- BUS controller:
 - complies with the PCI specifications v2.1
 - four 32-bit PCI slots (Masters), two ISA slots, one 32-bit AGP slot, and 4-layer PCB
 - **supports Universal Serial Bus—USB** (Optional cable)
- Peripheral controller:
 - System BIOS built-in NCR4.0 SCSI/SY-S8115 SCSI/SY-V325-2M Card BIOS and “Plug and Play” function
 - onboard built-in PCI Master IDE controller and floppy controller
 - onboard supports for two high speed UARTS (w/i 16550 FIFO) and Multimode parallel port for Standard, Enhanced (EPP) and high speed (ECP) modes, PS/2 mouse function
 - onboard FLASH Memory for easy upgrade BIOS
 - onboard IR support (optional cable)
 - AT/ATX power supply connectors available

Unpacking the Mainboard

The mainboard package contains:

- The 82440LX Mainboard
- One CD (including Manuals/Drivers/Utilities)

Note: Do not unpack the mainboard until you are ready to install it.

Follow the precautions below while unpacking the mainboard.

1. Before handling the mainboard, ground yourself by grasping an unpainted portion of the system's metal chassis.
2. Remove the mainboard from its anti-static packaging and place it on a grounded surface, component side up.
3. Check the mainboard for damage. If any chip appears loose, press carefully to seat it firmly in its socket.

Do not apply power if the mainboard appears damaged. If there is damage to the board contact your dealer immediately.

Electrostatic Discharge Precautions

Make sure you ground yourself before handling the mainboard or other system components. Electrostatic discharge can easily damage the components. Note that you must take special precaution when handling the mainboard in dry or air-conditioned environments.

Take these precautions to protect your equipment from electrostatic discharge:

- Do not remove the anti-static packaging until you are ready to install the mainboard and other system components.
- Ground yourself before removing any system component from its protective anti-static packaging. To ground yourself grasp the expansion slot covers or other unpainted portions of the computer chassis.
- Frequently ground yourself while working, or use a grounding strap.
- Handle the mainboard by the edges and avoid touching its components.

Mainboard Layout w/ Default Settings

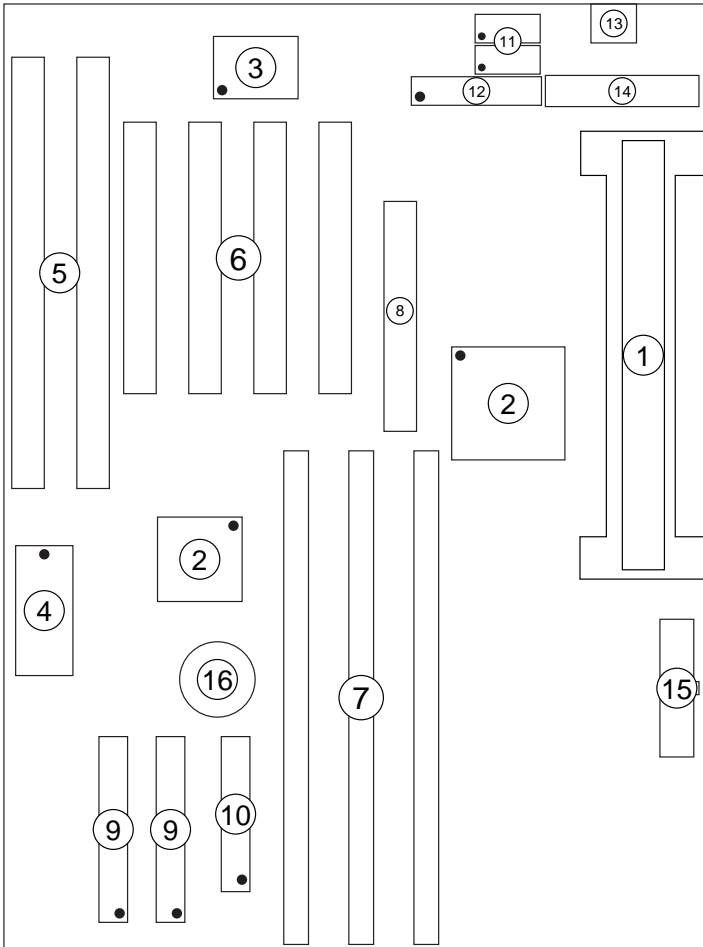

Figure 1-1. Mainboard Layout

- | | | | |
|----|--------------------|-----|------------------------------------|
| 1. | Slot 1 for PII CPU | 9. | IDE1/IDE2 Connector |
| 2. | 82440LX Chipset | 10. | Floppy Connector |
| 3. | Ultra I/O Chip | 11. | COM1/COM2 Connector |
| 4. | PnP FLASH BIOS | 12. | Parallel Port Connector |
| 5. | ISA Slot | 13. | Keyboard Connector |
| 6. | PCI Slot | 14. | AT Power Connector |
| 7. | DIMM Memory Bank | 15. | ATX Power Connector |
| 8. | AGP Port | 16. | CMOS Battery (Lithium battery, 3V) |

Default settings are as follows: Pentium II 233MHz CPU, On-board PCI Bus IDE Enabled, FDC Enabled, 2 high speed UARTS Enabled (w/ 16550 FIFO), 1 EPP/ECP port (ECP + EPP mode), and AT Power Supply.

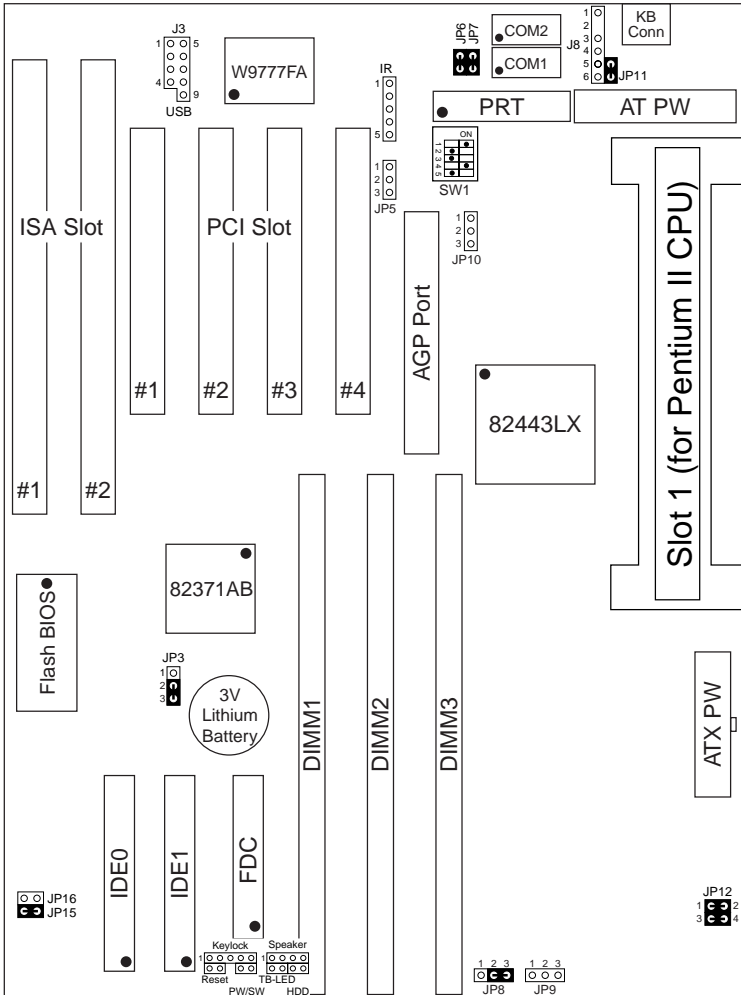

Figure 1-2. Mainboard Default Setting

Important: *Make sure the system is well ventilated to prevent overheating and ensure system stability.*

2 Hardware Setup



This chapter explains how to configure the mainboard's hardware. After you install the mainboard, you can set jumpers, install memory on the mainboard, and make case connections. Refer to this chapter whenever you upgrade or reconfigure your system.

CAUTION: *Turn off power to the mainboard, system chassis, and peripheral devices before performing any work on the mainboard or system.*

Jumpers

JP3: CMOS Clear Jumper

Clear the CMOS memory by momentarily shorting this jumper; then open the jumper to retain new settings.

CMOS Setting	JP3
Clear CMOS data	1 
Retain CMOS data (default)	1 

JP12/JP15/JP16: Power Supply Selection Jumper

These jumpers let you select either the AT or ATX power supply. Use only one power supply at a time on this mainboard.

	JP12	JP15	JP16
AT Power Supply (default)			
ATX Power Supply			

JP6/JP7/JP11: CE Test Jumper Pin

These jumpers are reserved for the CE test. If you run into problems during the CE test, unplug these jumper pins and try again.

SW1: Bus Fraction Core/Bus Ratio Select Jumper

Set this jumper according to your CPU clock.

Ratio	686 (PII) Family	SW1
3.5x (default)	686 (PII) – 233 MHz	
4.0x	686 (PII) – 266 MHz	
4.5x	686 (PII) – 300 MHz	
5.0x	686 (PII) – 330 MHz	

CPU Type Configuration

Set the mainboard's CPU switch SW1 according to CPU type as described below.

686 (PII) – 233 CPU Settings (3.5 x clock)



Figure 2-1-1. CPU Jumper Settings

686 (PII) – 266 CPU Settings (4.0 x clock)



Figure 2-1-2. CPU Jumper Settings

686 (PII) – 300 CPU Settings (4.5 x clock)

*Figure 2-1-3. CPU Jumper Settings*

686 (PII) – 330 CPU Settings (5.0 x clock)

*Figure 2-1-4. CPU Jumper Settings*

Memory Configuration

The mainboard supports three banks of **168-pin 3.3V EDO/SDRAM Unbuffered DIMM**. The mainboard supports **from 8 to 384 Mbytes** with no other restrictions on memory configurations. You can install DRAM in any combination without having to rely on a memory configuration table. Memory configuration is thus “**Table-Free**” in any bank.

Multi I/O Port Addresses

Default settings for multi-I/O port addresses are shown in the table below.

Port	I/O Address	IRQ	Status
LPT1*	378H	7	ECP + EPP
COM1	3F8H	4	
COM2	2F8H	3	

* If default I/O port addresses conflict with other I/O cards (e.g. sound cards or I/O cards), you must adjust one of the I/O addresses to avoid address conflict. (You can adjust these I/O addresses from the BIOS.)

Note: Some sound cards have a default IRQ setting for IRQ7, which may conflict with printing functions. If this occurs do not use sound card functions at the same time you print.

Connectors

Attach the mainboard to case devices, or an external battery, via connectors on the mainboard. Refer to Figure 1-1 for connector locations and connector pin positions.

AT PW — Power Supply Connectors

The mainboard requires a power supply with at least 200 watts and a “power good” signal. AT PW has two 6-pin male header connectors. Plug the dual connectors from the power directly onto the board connector while making sure the black leads are in the center.

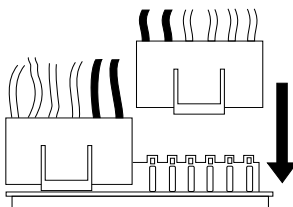

ATX PW — ATX Power Supply Connectors

The motherboard provides an ATX power supply connector. It is a twenty-pin male header connector. Plug the connector from the power

directly onto the board connector while making sure the pin1 is in its position.

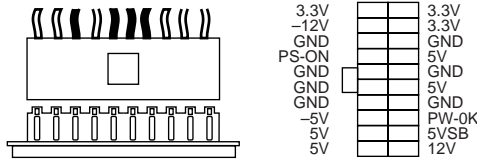

J8 — PS/2 Keyboard Connector

Attach a 5-pin male PS/2 mouse cable to this connector to enable the PS/2 mouse function.

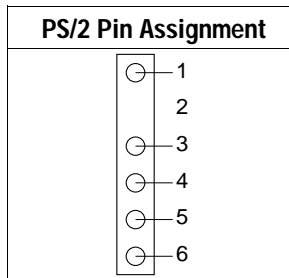

IR – IR Connector

A five-pin wafer connector is for connecting to the IR device. Use the device that has the ASKIR or HPSIR specification and choose ASKIR/HPSIR from the BIOS setup.

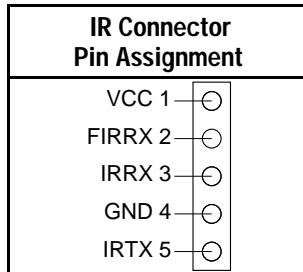

Keylock — Keylock & Power LED Connector

This connector is for a lock that may be installed on the system case for enabling or disabling the keyboard. This connector also attaches to the case’s Power LED. (Pin 1, 3 for power LED, pin 4, 5 for keylock.)

SPEAKER – Speaker Connector

Attach the system speaker to connector SPK.

RESET – Hardware Reset Control

Attach the Reset switch to RESET. Closing the Reset switch restarts the system.

IDE1/IDE2 – On-board Primary/Secondary IDE HDD Connectors

Attach on-board hard disk drives to these connectors.

COM1/COM2 Connectors

Connect COM1/COM2 devices to these connectors.

HDD LED – IDE HDD LED Connectors

Attach on-board IDE device LEDs to this connector. The LED lights when an IDE device is active.

FDC Connector

Attach floppy cable to this connector.

PRT – Parallel Port Connector

Attach parallel port cable to this connector.

USB (J3) – (Universal Serial Bus) Connector

Attach USB cable to these connectors for external USB device. Please ask your dealer for the cable.

PW/SW – ATX Power Supply On/Off Switch Connector (Momentary Type)

Attach a two-pin switch to this connector for turning the ATX power supply on/off. Don't forget to remove all jumper caps on JP12 to enable the ATX power supply function.

TB LED — Turbo LED Connector

Attach a 2-pin turbo LED cable to it. The LED lights when the system is in turbo mode. Manufacture default has set the board in turbo mode due to most of hardware and software are compliance to turbo mode.

FAN (JP10) — CPU Cooling Fan Connector

This 3-pins connector provides 12V power for the CPU cooling fan which matches the pin assignment of this connector. If you enable the Suspend Mode function in BIOS setup, this fan will stop when the system is into the suspend mode.

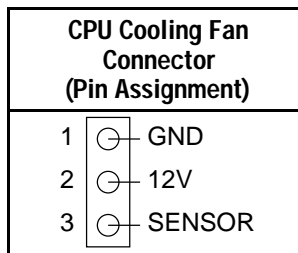

Note: Make sure the pin assignment of our CPU Cooling Fan is matched with this connector before connecting it, otherwise, you may damage either the mainboard or the cooling fan.

JP9 – Wake-On-LAN (WOL) Header

Attach a 3-pin connector from the LAN card which supports the Wake-On-LAN (WOL) function. This function lets users wake up the connected computer through the LAN card. (The cable should be included with the LAN card.)

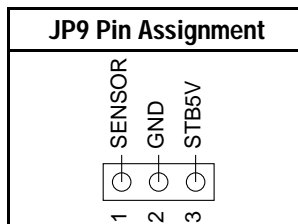

Slot 1 Installation Guide

This mainboard provides a non-boxed 686 (PII) CPU retention set to secure the CPU on this board. Follow the steps below to secure this type of CPU on to your motherboard.

Step 1:

Find the ATX PW and the Slot 1 on the board and set the board in the direction as follows before doing any installation.

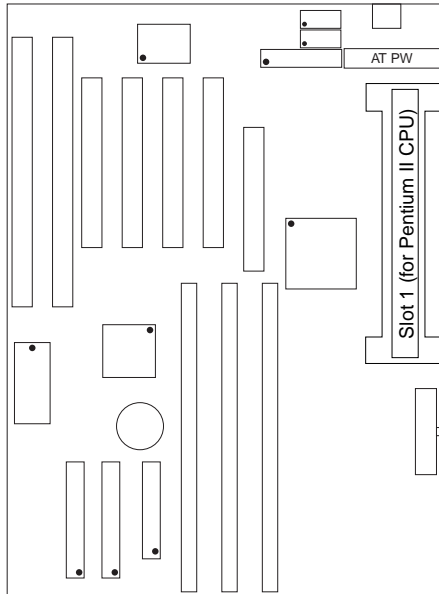

Install the 2 pairs of screws, as shown in the following figure, from the bottom of the motherboard upward onto the mainboard.

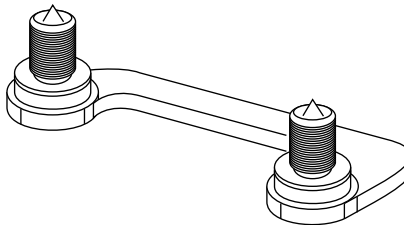

Step 2:

Insert the supporting base, which is shown below, into the two holes directly to the left of the 2 sets of screws that have just been inserted on to the board.

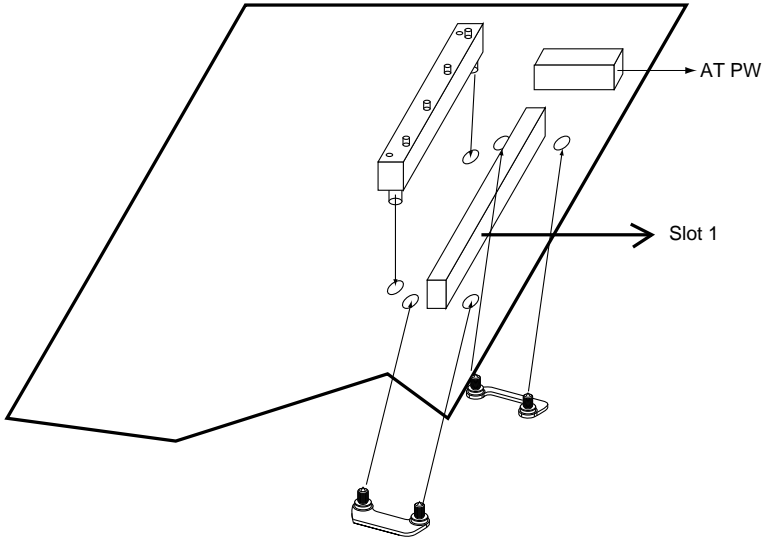

Step 3:

Insert the clip portion of the CPU supporter, which is shown below, so that the heat sink can sit on the top of the whole CPU supporter.

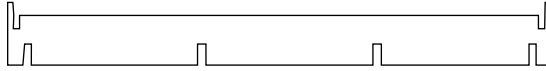

Top View of CPU Support Clip

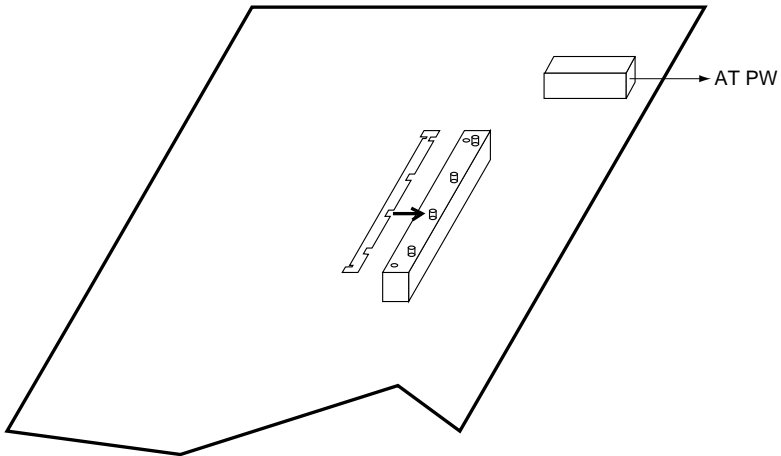

Step 4:

Insert the 2 latches into the two holes of the supporting base and then turn them 90° to secure the CPU.

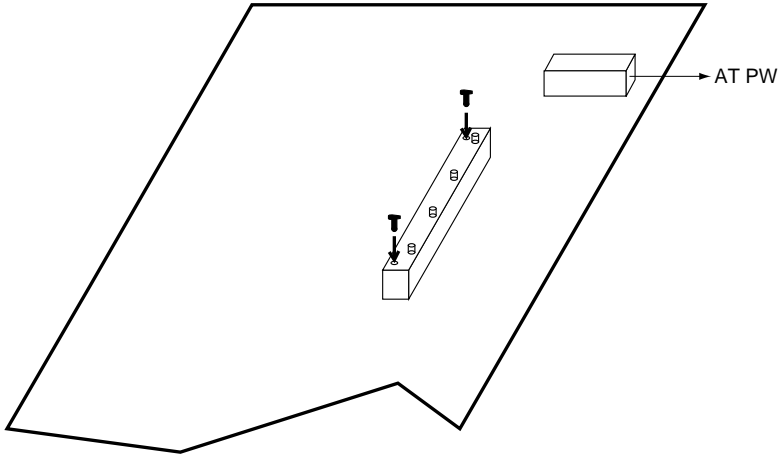

Step 5:

Set the retention clip right on the top of the 2 sets of screws which are along the sides of Slot1 and then tighten the 4 screws on the retention clip.

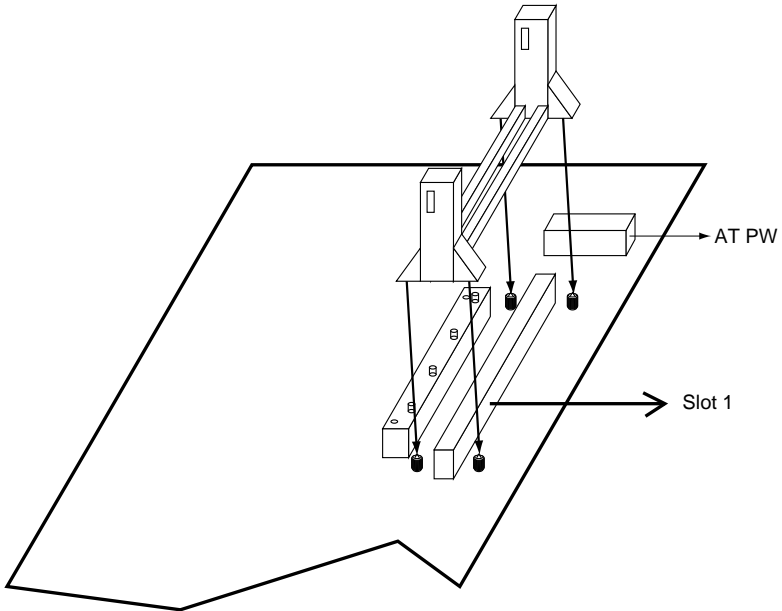

Step 6:

Insert the CPU into the retention clip and notice that the heat sink is on the left hand side of the board. Lock the two latches on the sides of the CPU to secure the CPU.

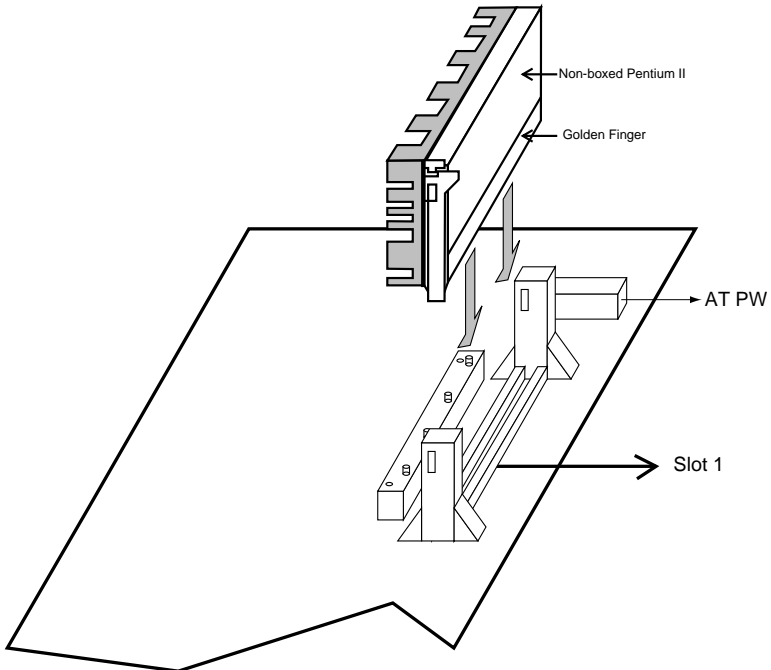

3 BIOS Setup

The mainboard's BIOS setup program is the ROM PCI/ISA BIOS from Award Software Inc. Enter the Award BIOS program's Main Menu as follows:

1. Turn on or reboot the system. After a series of diagnostic checks, you are asked to press DEL to enter Setup.
2. Press the key to enter the Award BIOS program and the main screen appears:

ROM PCI/ISA BIOS
CMOS SETUP UTILITY
AWARD SOFTWARE, INC.

STANDARD CMOS SETUP	INTEGRATED PERIPHERALS
BIOS FEATURES SETUP	SUPERVISOR PASSWORD
CHIPSET FEATURES SETUP	USER PASSWORD
POWER MANAGEMENT SETUP	IDE HDD AUTO DETECTION
PNP/PCI CONFIGURATION	SAVE & EXIT SETUP
LOAD SETUP DEFAULTS	EXIT WITHOUT SAVING
LOAD BIOS DEFAULTS	
Esc : Quit	↑ ↓ → ← : Select Item
F10 : Save & Exit Setup	(Shift) F2 : Change Color
Time, Date, Hard Disk Type...	

3. Choose an option and press <Enter>. Modify the system parameters to reflect the options installed in the system. (See the following sections.)
4. Press <ESC> at anytime to return to the Main Menu.
5. In the Main Menu, choose "SAVE AND EXIT SETUP" to save your changes and reboot the system. Choosing "EXIT WITHOUT SAVING" ignores your changes and exits the program.

The Main Menu options of the Award BIOS are described in the sections that follow.

Standard CMOS Setup

Run the Standard CMOS Setup as follows.

1. Choose "STANDARD CMOS SETUP" from the Main Menu. A screen appears.

ROM PCI/ISA BIOS
STANDARD CMOS SETUP
AWARD SOFTWARE, INC.

Date (mm:dd:yy) : Fri, Feb 1 1995															
Time (hh:mm:ss) : 7 : 30 : 33															
HARD DISKS	TYPE	SIZE	CYLS	HEAD	PRECOMP	LANDZ	SECTOR MODE								
Primary Master	: AUTO	0	0	0	0	0	0 AUTO								
Primary Slave	: None	0	0	0	0	0	0 ----								
Secondary Master	: None	0	0	0	0	0	0 ----								
Secondary Slave	: None	0	0	0	0	0	0 ----								
Drive A : 1.44M, 3.5 in.				<table border="1"> <tr> <td>Base Memory:</td> <td>640K</td> </tr> <tr> <td>Extended Memory:</td> <td>3328K</td> </tr> <tr> <td>Other Memory:</td> <td>128K</td> </tr> <tr> <td colspan="2">Total Memory: 4096K</td> </tr> </table>				Base Memory:	640K	Extended Memory:	3328K	Other Memory:	128K	Total Memory: 4096K	
Base Memory:	640K														
Extended Memory:	3328K														
Other Memory:	128K														
Total Memory: 4096K															
Drive B : None															
Floppy 3 Mode Support : Disabled															
Video : EGA/VGA															
Halt On : All Errors															
Esc : Quit		↑ ↓ → ← : Select Item		PU/PD/+/- : Modify											
F11 : Help		(Shift) F2 : Change Color		F3 : Toggle Calendar											

2. Use arrow keys to move between items and select values. Modify selected fields using PgUp/PgDn/+/- keys. Some fields let you enter values directly.

Date (mm/dd/yy) Type the current date.

Time (hh:mm:ss) Type the current time.

Primary (Secondary) Master & Slave Choose from the standard hard disk types 1 to 46. Type 47 is user definable. If a hard disk is not installed choose "Not installed." (default)

Drive A & B Choose 360KB , 5 1/4 in.,
1.2MB , 5 1/4 in.,
720KB , 3 1/2 in.,
1.4M , 3 1/2 in.(default),
2.88 MB, 3 1/2 in. or
Not installed

Video	Choose Monochrome, Color 40x25, VGA/EGA (default), Color 80x25
Floppy 3 Mode Support	Choose Disabled (default) or Enabled. When enables this function, the system will support 720KB/1.25MB/1.44MB 3 different modes floppy diskette. <i>Note: This function is for a special disk drive which happens to be popular in Japan.</i>
Halt On	Choose halt mode when BIOS detects system errors: All Errors (default) All, But Diskette No Errors All, But Keyboard All, But Disk/Key

3. When you finish, press the <ESC> key to return to the Main Menu.

BIOS Features Setup

Run the BIOS Features Setup as follows.

1. Choose “BIOS FEATURES SETUP” from the Main Menu and a screen with a list of items appears. (**The screen below shows the BIOS default settings.**)

ROM PCI/ISA BIOS
BIOS FEATURES SETUP
AWARD SOFTWARE, INC.

Virus Warning	: Disable	Video BIOS Shadow	: Enabled
CPU Internal Cache	: Enabled	C8000-CBFFF Shadow	: Disabled
External Cache	: Enabled	CC000-CFFFF Shadow	: Disabled
Quick Power on Self Test	: Enabled	D0000-D3FFF Shadow	: Disabled
Boot Sequence	: A,C,SCSI	D4000-D7FFF Shadow	: Disabled
Swap Floppy Drive	: Disabled	D8000-DBFFF Shadow	: Disabled
Boot Up Floppy Seek	: Enabled	DC000-DFFFF Shadow	: Disabled
Boot Up NumLock Status	: On		
Boot Up System Spped	: High		
Gate A20 Option	: Fast		
Typematic Rate Setting	: Disabled		
Typematic Rate (Chars/Sec)	: 6	ESC : Quit	↑ ↓ → ←: Select Item
Typematic Delay (Msec)	: 250	F1 : Help	PU/PD/+/- : Modify
Security Option	: Setup	F5 : Old Values (Shift)F2 : Color	
PCI/VGA Palette Snoop	: Disabled	F6 : Load BIOS Defaults	
OS Select for DRAM >64MB	: Non-OS2	F7 : Load Setup Defaults	

2. Use the arrow keys to move between items and to select values. Modify the selected fields using the PgUp/PgDn/+/- keys. <F> keys are explained below:

<F1>: “Help” gives options available for each item.

Shift <F2>: Change color.

<F5>: Get the old values. These values are the values with which the user started the current session.

<F6>: Load all options with the BIOS Setup default values.

<F7>: Load all options with the Power-On default values.

A short description of screen items follows:

Virus Warning Enable this option will allow BIOS to protect the boot sectors and partition tables of your hard disk. Any attempt to write to them will cause the system to halt and display a warning message.

CPU Internal Cache This option enables/disables the CPU’s internal cache. (The Default setting is Enabled.)

External Cache This option enables/disables the external cache memory. (The Default setting is Enabled.)

Quick Power On Self Test	Enabled provides a fast POST at boot-up .
Boot Sequence	Choose the boot device sequence as your need. For example, "A, C, SCSI" means that BIOS will look for an operating system first from drive A, drive C, then SCSI device. Options of this function are: A, C, SCSI; C,A, SCSI; C, CD-ROM, A; CD-ROM, C, A; D, A, SCSI; E, A, SCSI; F, A, SCSI; SCSI, A, C; SCSI, C, A; C only; LS/ZJP.C.
Swap Floppy Drive	Enabled changes the sequence of the A: and B: drives. (The Default setting is Disabled.)
Boot Up Flppy Seel	Choose Enabled then the BIOS will look for the floppy while the system is booting up.
Boot Up Num Lock Status	Choose On or Off. On puts numeric keypad in Num Lock mode at boot-up. Off puts this keypad in arrow key mode at boot-up.
Boot Up System Speed	Choose the boot-up speed. Options are either high or low.
Gate A20 Option	Choose Fast (default) o Normal. Fast allows RAM accesses above 1MB using the fast gate A20 line.
Typematic Rate Setting	Enable this option to adjust the keystroke repeat rate.
Typematic Rate (Chars/Sec)	Choose the rate a character keeps repeating.
Typematic Delay (Msec)	Choose how long after you press a key that a character begins repeating.

Security Option	Choose Setup or System. Use this feature to prevent unauthorized system boot-up or use of BIOS Setup. “System” – Each time the system is booted the password prompt appears. “Setup”– If a password is set, the password prompt only appears if you attempt to enter the Setup program.
PCI/VGA Palette Snoop	Enabled: The color of the monitor may be incorrect if uses with MPEG card. Enable this option to make the monitor normal. Disabled: Default setting.
OS Select for DRAM >64MB	OS2: Choosing this when you are using OS/2 operation system. Non-OS/2: Choosing this when you are using no-OS/2 operation system.
Video or Adapter BIOS Shadow	BIOS shadow copies BIOS code from slower ROM to faster RAM. BIOS can then execute from RAM. These 16K segments can be shadowed from ROM to RAM. BIOS is shadowed in a 16K segment if it is enabled and it has BIOS present.

3. After you have finished with the BIOS Features Setup program, press the <ESC> key and follow the screen instructions to save or disregard your settings.

Chipset Features Setup

The Chipset Features Setup option changes the values of the chipset registers. These registers control system options in the computer.

Note: Change these settings only if you are familiar with the Chipset.

Run the Chipset Features Setup as follows.

1. Choose “CHIPSET FEATURES SETUP” from the Main Menu and the following screen appears. (The screen below shows default settings.)

ROM PCI/ISA BIOS CHIPSET FEATURES SETUP AWARD SOFTWARE, INC.			
Auto Configuration	: Enabled	SDRAM CAS Latency Time	: 3
DRAM Speed Selection	: 60 ns	Spread Spectrum Modulated	: Disabled
MA Wait State	: Slow	CPU Warning Temperature	: Disabled
EDO RAS# To CAS# Delay	: 3	Current CPU Temperature	: 40°C/104°F
EDO RAS# Precharge Time	: 3	Current System Temperature	: 44°C/111°F
EDO DRAM Read Burst	: x3/3/3	Current CPUFAN1 Speed	: 5113 RPM
EDO DRAM Write Bursts	: x3/3/2	3.3(V) :	2.78 V VTT(V) :
DRAM Data Integrity Mode	: Non-ECC	+12(V) :	11.84V -12(V) :
CPU-TO-PCI IDE Posting	: Enabled	-5(V) :	-4.88V
System BIOS Cacheable	: Disabled		
Video BIOS Cacheable	: Disabled	ESC :	Quit ↑ ↓ → ← :
Video RAM Cacheable	: Disabled	F1 :	Help PU/PD/+/- :
8 Bit I/O Recovery Time	: 3	F5 :	Old Values (Shift)F2 :
16 Bit I/O Recovery Time	: 2	F6 :	Load BIOS Defaults
Memory Hole At 15M-16M	: Disabled	F7 :	Load Setup Defaults
Passive Release	: Enabled		
Delay Transaction	: Disabled		
AGP Aperture Size (MB)	: 64		
SDRAM RAS-to-CAS Delay	: Slow		
SDRAM RAS Precharge Time	: Slow		

2. Use the arrow keys to move between items and select values. Modify selected fields using the PgUp/PgDn/+/- keys.

A short description of screen items follows:

Auto Configuration Enable this option (strongly recommended) and the system automatically sets all options on the left side of the screen (except cache update mode & BIOS cacheable).
If this option is Enabled you must boot from Turbo mode.

MA Wait State Use the default setting.

EDO RAS# to CAS# Delay Use the default setting.

EDO RAS# Precharge Time	Use the default setting.
EDO DRAM Read Burst	Use the default setting.
DRAM Write Burst	Use the default setting.
DRAM Data Integrity Mode	Choose Non-ECC (default) or ECC according to the DRAM type you have.
CPU-TO-PCI IDE Posting	Use the default setting.
System BIOS Cacheable	Disabled: The ROM area F0000H-FFFFFH is not cached. Enabled: The ROM area F0000H-FFFFFH is cacheable if cache controller is enabled.
Video BIOS Cacheable	Disabled: The video BIOS C0000H-C7FFFH is not cached. Enabled: The video BIOS C0000H-C7FFFH is cacheable if cache controller is enabled.
8Bit I/O Recovery Time	Use the default setting.
16Bit I/O Recovery Time	Use the default setting.
Memory Hole At 15M-16M	Choose Enabled or Disabled (default). Some interface cards will map their ROM address to this area. If this occurs, you should select Enabled, otherwise use Disabled.
Passive Release	Use the default setting.
Delayed Transaction	Use the default setting.
AGP Aperture Size	AGP could use the DRAM as its video RAM. Choose the DRAM size that you want it to be used as video RAM. The range is from 4MB to 256MB.

SDRAM RAS-to-CAS Delay	Use the default setting.
SDRAM RAS Precharge Time	Use the default setting.
SDRAM CAS Latency Time	Use the default setting.
Spread Spectrum Modulated	Enabled it when you want to run the FCC or DOC testing.
CPU Warning Temperature	Choose Disabled (default) or Enabled . Set CPU temperature from 50°C to 70°C. The system will slow down automatically when CPU temperature goes beyond the preset value. CPU will continue to run slow until the CPU temperature returns back within the safe range.
Current CPU Temperature; System Temp and CPU FAN1 Speed; Vcore	Show the current status of CPU.

3. After you have finished with the Chipset Features Setup, press the <ESC> key and follow the screen instructions to save or disregard your settings.

Power Management Setup

The Power Management Setup option sets the system's power saving functions.

Run the Power Management Setup as follows.

1. Choose "POWER MANAGEMENT SETUP" from the Main Menu and a screen with a list of items appears.

ROM PCI/ISA BIOS CMOS SETUP UTILITY POWER MANAGEMENT SETUP	
Power Management	: Disabled
PM Control by APM	: Yes
Video Off Method	: V/H SYNC+Blank
Video Off After	: Standby
Modem Use IRQ	: 3
Doze Mode	: Disabled
Standby Mode	: Disabled
Suspend Mode	: Disabled
HDD Power Down	: Disabled
Throttle Duty Cycle	: 62.5%
ZZ Active in Suspen	: Disabled
VGA Active Monitor	: Enabled
Soft-Off by PWR-BTN	: Instant-Off
Resume by Ring	: Disabled
Resume by Alarm	: Disabled
IRQ 8 Break Suspend	: Disabled
** Relead Global Timer Events ** IRQ [3-7.9-15], NMI : Disabled Primary IDE 0 : Disabled Primary IDE 1 : Disabled Secondary IDE 0 : Disabled Secondary IDE 1 : Disabled Floppy Disk : Disabled Serial Port : Enabled Parallel Port : Disabled	
ESC : Quit ↑↓→←: Select Item F1 : Help PU/PD/+/- : Modify F5 : Old Values (Shift)F2 : Color F6 : Load BIOS Defaults F7 : Load Setup Defaults	

2. Use the arrow keys to move between items and to select values. Modify the selected fields using the PgUp/PgDn/+/- keys.

A short description of selected screen items follows:

Power

Options are as follows:

Management

User Define Let's you define the HDD and power down times.

Disabled Disables the Green PC Features.

Min Saving Doze timer = 1 Hour
Standby timer = 1 Hour
Suspend timer = 1 Hour
HDD Power Down = 15 Min

Max Saving Doze timer = 1 Min
Standby timer = 1 Min
Suspend timer = 1 Min
HDD Power Down = 1 Min

PM Control by APM

Choose Yes or No (default). APM stands for Advanced Power Management. To use APM, you must run "power.exe" under DOS v6.0 or later version.

Video Off Method	Choose V/H Sync+Blank (default), Blank screen, or DPMS for the selected PM mode.
Video Off After	Choose the mode you want video to go off after the mode is being active. Options are Standby, Suspend, and Doze.
Doze Mode	When the set time has elapsed, the BIOS sends a command to the system to enter doze mode (system clock drops to 33MHz). Time is adjustable from 1 Min to 1 Hour.
Standby Mode	The default is Disabled. Time is adjustable from 1 Min to 1 Hour.
Suspend Mode	The default is Disabled. Only an SL-Enhanced (or SMI) CPU can enter this mode. Time is adjustable from 1 Min to 1 Hour. Under Suspend mode, the CPU stops completely (no instructions are executed.)
HDD Power Down	When the set time has elapsed, the BIOS sends a command to the HDD to power down, which turns off the motor. Time is adjustable from 1 to 15 minutes. The default setting is Disabled. Some older model HDDs may not support this advanced function.
Throttle Duty Cycle	Using the default setting.
ZZ Active in suspend	Using the default setting.
VGA Active Monitor	Choose Enabled (default) or Disabled. Enabled –enables the power management timers when a “no activity” event is detected.
Soft-Off by POR-BTTN	Choose Instant-off (default) or Delay 4 Sec. Delay 4 Sec turns off the system power 4 seconds after pushing the power button

- Resume by Ring** Choose **Enabled** or **Disabled** (default). This function only works when the computer is powered on.
Enabled: The system will resume active when modem is ringing.
Disabled: The system will not resume when modem is ringing.
- Resume by Alarm** Choose **Enabled** or **Disabled** (default).
Enabled: Set alarm to wake up the system either by the date (1-31) or time (hh:mm:ss), and if the date is set to 0, it means that the system will wake up by the alarm everyday.
Disabled: The system ignores the alarm.
- IRQ8 Clock Event** Choose **Enabled** or **Disabled** (default). Alarm function will be activated when this function is enabled.
- IRQ[3-7,9-15], NMI** Choose **Enabled** (default) or **Disabled**. The BIOS monitors these items for activities. If activity occurs from the Enabled item the system then wakes up.
- Primary/
Secondary IDE0
Primary/
Secondary IDE1** Choose **Enabled** or **Disabled** (default).
Enabled: enables the power management timers when “no activity” event is detected.
- Floppy Disk/serial
Port/Parallel Port** Choose **Enabled** or **Disabled**.
Enabled: enables the power management timers when “no activity” event is detected.

3. After you have finished with the Power Management Setup, press the <ESC> key to return to the Main Menu.

PNP/PCI Configuration Setup

This option sets the mainboard's PCI Slots. Run this option as follows:

1. Choose "PNP/PCI CONFIGURATION SETUP" from the Main Menu and the following screen appears. (The screen below shows default settings.)

ROM PCI/ISA BIOS PNP/PCI CONFIGURATION AWARD SOFTWARE, INC.	
Resources Controlled By : Manual	PCI IRQ Activated By : Level
Reset Configuration Data : Disabled	PCI IDE IRQ Map To : PCI-AUTO
	Primary IDE INT# : A
	Secondary IDE INT# : B
IRQ-3 assigned to : Legacy ISA*	
IRQ-4 assigned to : Legacy ISA*	
IRQ-5 assigned to : PCI/ISA PnP*	
IRQ-7 assigned to : Legacy ISA*	
IRQ-9 assigned to : PCI/ISA PnP*	
IRQ-10 assigned to : PCI/ISA PnP*	
IRQ-11 assigned to : PCI/ISA PnP*	
IRQ-12 assigned to : PCI/ISA PnP*	
IRQ-14 assigned to : Legacy ISA*	
IRQ-15 assigned to : Legacy ISA*	
DMA-0 assigned to : PCI/ISA PnP*	ESC : Quit ↑↓→← : Select Item
DMA-1 assigned to : PCI/ISA PnP*	F1 : Help PU/PD/+/- : Modify
DMA-3 assigned to : PCI/ISA PnP*	F5 : Old Values (Shift)F2 : Color
DMA-5 assigned to : PCI/ISA PnP*	F6 : Load BIOS Defaults
DMA-6 assigned to : PCI/ISA PnP*	F7 : Load Setup Defaults
DMA-7 assigned to : PCI/ISA PnP*	

- *: These items will disappear when Resource Controlled. is Auto.
2. Use the arrow keys to move between items and select values. Modify selected fields using the PgUp/PgDn/+/- keys.

A short description of screen items follows:

Resources Controlled By	Manual: BIOS doesn't manage PCI/ISA PnP card (i.e., IRQ) automatically.
	Auto: BIOS auto manage PCI and ISA PnP card (recommended).
Reset Configuration Data	Disabled: Retain PnP configuration data in BIOS.
	Enabled: Reset PnP configuration data in BIOS.

IRQX and DMAX assigned to	Choose PCI/ISA PnP or Legacy ISA. If the first item is set to Manual, you could choose IRQX and DMAX assigned to PCI/ISA PnP card or ISA card. PCI/ISA PnP: BIOS auto assigns IRQ/DMA to the device. Legacy ISA: User assigns IRQ/DMA to the device.
PCI IRQ Activated By	Choose Edge or Level. Most PCI trigger signals are Level. This setting must match the PCI card.
PCI IDE IRQ Map To	Select PCI-AUTO, ISA, or assign a PCI SLOT number (depending on which slot the PCI IDE is inserted). The default setting is PCI-AUTO. If PCI-AUTO does not work, then assign an individual PCI SLOT number.
Primary IDE INT#	Choose INTA#, INTB#, INTC#, or INTD#. The default setting is INTA#.
Secondary IDE INT#	Choose INTA#, INTB#, INTC#, or INTD#. The default setting is INTB#.

3. After you have finished with the PCI Slot Configuration, press the <ESC> key and follow the screen instructions to save or disregard your settings.

Load Setup Defaults

This item loads the system values you have previously saved. Choose this item and the following message appears:

“Load SETUP Defaults (Y/N)? N”

To use the SETUP defaults, change the prompt to “Y” and press <Enter>.

Note: The SETUP Defaults are optimized for the most stabilized performance.

Load BIOS Defaults

Choose this item and the following message appears:

“Load BIOS Defaults (Y/N)?N”

To use the BIOS defaults, change the prompt to “Y” and press <Enter>.

Note: BIOS DEFAULTS values are adjusted for high performance. If you run into any problems after loading BIOS DEFAULTS, please load the SETUP DEFAULTS for the stable performance.

Integrated Peripherals

The Integrated Peripherals option changes the values of the chipset registers. These registers control system options in the computer.

Note: Change these settings only if you are familiar with the Chipset.

Run the Integrated Peripherals as follows.

1. Choose “Integrated Peripherals” from the Main Menu and the following screen appears. (The screen below shows default settings.,

ROM PCI/ISA BIOS INTEGRATED PERIPHERALS AWARD SOFTWARE, INC.	
IDE HDD Block Mode : Enabled	USB Controller : Enabled
IDE Primary Master PIO : Auto	
IDE Primary Slave PIO : Auto	
IDE Secondary Master PIO : Auto	
IDE Secondary Slave PIO : Auto	
On-Chip Primary PCI IDE: Enabled	
On-Chip Secondary PCI IDE: Enabled	
PCI Slot IDE 2nd Channel : Enabled	
Onboard FDD Controller : Enabled	
Onboard Serial Port 1 : 3F8/IRQ4	
Onboard Serial Port 2 : 2F8/IRQ3	
UART 2 Mode : Standard	
Onboard Parallel Port : 378H/IRQ7	ESC : Quit ↑ ↓ → ← : Select Item
Onboard Parallel MODE : ECP/EPP	F1 : Help PU/PD/+/- : Modify
ECP Mode Use DMA : 3	F5 : Old Values (Shift)F2 : Color
Parallel Port EPP Type : EPP1.9	F6 : Load BIOS Defaults
	F7 : Load Setup Defaults

2. Use the arrow keys to move between items and select values. Modify selected fields using the PgUp/PgDn/+/- keys.

A short description of screen items follows:

IDE HDD Block Mode	Choose Enabled (default) or Disabled. Enabled invokes multi-sector transfer instead of one sector per transfer. Not all HDDs support this function.
IDE Primary Master PIO	Choose Auto (default) or mode 0~4. Mode 0 is the slowest speed, and HDD mode 4 is the fastest speed. For better performance and stability, we suggest you use the Auto setting to set the HDD control timing.
IDE Primary Slave PIO	
IDE Secondary Master PIO	
IDE Secondary Slave PIO	
On-chip Primary/ Secondary PCI IDE	Enabled: Use the on-board IDE (default) Disabled: Turn off the on-board IDE
PCI Slot IDE 2nd Channel	Choose Enabled (default) or Disabled. When Enabled is set, IRQ15 is dedicated for secondary IDE use. When Disabled is set, IRQ15 is released for other devices.
Onboard FDC Controller	Enabled: Use the on-board floppy controller (default). Disabled: Turn off the on-board floppy controller.
Onboard Serial Port 1 Onboard Serial Port 2	Choose serial port 1 & 2's I/O address. Do not set port 1 & 2 to the same value except for Disabled. COM 1/3F8H COM3/3E8H COM 2/2F8H COM4/2E8H (default)
UART 2 Mode	Standard: Use standard UART mode (default). ASK IR: Use UART with ASK. IR function enable. HPSIR: Use UART with HP.. Serial IR function enable.
Onboard Parallel Port	Choose the printer I/O address: 378H/IRQ7 (default), 3BCH/IRQ7, 278H/IRQ5

Onboard Printer Mode	Choose SPP, ECP, EPP/SPP, or ECP/EPP mode. The mode depends on your external device that connects to this port.
ECP Mode Use DMA	Choose 3 (default) or 1 to select DMA3 or DMA1 when using the ECP device.
Parallel Port EPP Type	Choose EPP specification Ver. 1.7 (default) or 1.9.
USB Controller	Enable it when you are using the USB device.

Supervisor Password

Based on the setting you made in the “Security Option” of the “BIOS FEATURES SETUP”, this Main Menu item lets you configure the system so that a password is required every time the system boots or an attempt is made to enter the Setup program. Change the password as follows:

1. Choose “SUPERVISOR PASSWORD” in the Main Menu and press <Enter>. The following message appears:

“Enter Password:”

2. Enter a password and press <Enter>.
(If you do not wish to use the password function, you can just press <Enter> and a “Password disabled” message appears.)
3. After you enter your password, the following message appears prompting you to confirm the new password:

“Confirm Password:”

4. Re-enter your password and then Press <ESC> to exit to the Main Menu.
5. You have the right to change any changeable settings in the “CMOS SETUP UTILITY.”

Important: If you forget or lose the password, the only way to access the system is to set jumper JP5 to clear the CMOS RAM. All setup information is lost and you must run the BIOS setup program again.

User Password

Based on the setting you made in the “Security Option” of the “BIOS FEATURES SETUP”, this Main Menu item lets you configure the system so that a password is required every time the system boots or an attempt is made to enter the Setup program. Change the password as follows:

1. Choose “USER PASSWORD” in the Main Menu and press <Enter>. The following message appears:

“Enter Password:”

2. Enter a password and press <Enter>. (If you do not wish to use the password function, you can just press <Enter> and a “Password disabled” message appears.)
3. After you enter your password, the following message appears prompting you to confirm the new password:

“Confirm Password:”

4. Re-enter your password and then Press <ESC> to exit to the Main Menu.
5. You are not allowed to change any setting in “CMOS SETUP UTILITY” except change user’s password.

Important: If you forget or lose the password, the only way to access the system is to set jumper JP5 to clear the CMOS RAM. All setup information is lost and you must run the BIOS setup program again.

IDE HDD Auto Detection

This Main Menu item automatically detects the hard disk type and configures the STANDARD CMOS SETUP accordingly.

*Note: This function is only valid for **IDE** hard disks.*

ROM PCI/ISA BIOS
 CMOS SETUP UTILITY
 AWARD SOFTWARE, INC.

HARD DISKS	TYPE	SIZE	CYLS	HEAD	PRECOMP	LANDZ	SECTOR	MODE
Primary Master	: None	0	0	0	0	0	0	----
Primary Slave	: None	0	0	0	0	0	0	----
Secondary Master	: None	0	0	0	0	0	0	----
Secondary Slave	: None	0	0	0	0	0	0	----

Do you accept this drive C (Y/N)? N

ESC : Skip

Quick Installation Guide

This Quick Installation Guide leaflet is designed for those people who are familiar with motherboard settings to set up this new motherboard in order to boot up the system. Refer back to the proper chapters if you have run in to any problems.

Motherboard Layout

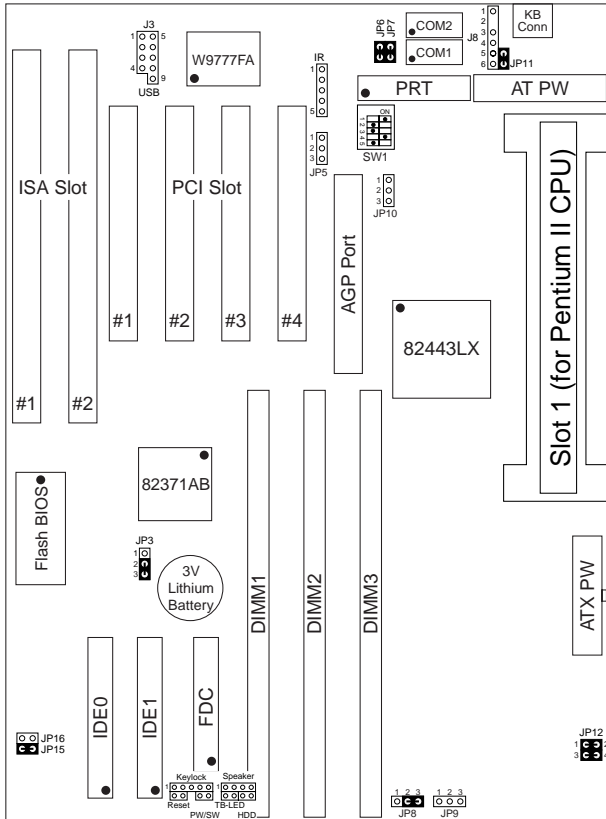

CPU Jumper Settings

CPU Frequency Settings		SW1				
Processor Type	Multiplier	1	2	3	4	5
Pentium II 233MHz	3.5x (default)	on	off	off	on	off
Pentium II 266MHz	4.0x	off	on	on	on	off
Pentium II 300MHz	4.5x	off	on	off	on	off
Pentium II 330MHz	5.0x	off	off	on	on	off

Memory Configurations

	DIMM BANKS		
	DIMM1	DIMM2	DIMM3
RAM Type	EDO/SDRAM		
Size	8/16/32/64/128		

Note: This mainboard requires 3.3V DIMM with an access time of 70ns or less, it supports memory size from 8 to 512MB and you may use any combination of DIMMs in the banks.

Connectors and Jumper Settings

CMOS clear: JP3		USB1 and 2 (J3)	CPU Cooling Fan: FAN (JP10)			
Retain CMOS data (default)	2-3	Connect your USB devices to these headers	pin	1	2	3
			function	GND	12V	sensor
Clear CMOS data	1-2	Please connect the WOL cable from your LAN card to this jumper.	wake on LAN jumper: JP9		RESET	HDD
			Connect the reset button to this jumper.		Connect the HDD led to this jumper.	
Power supply selection Jumper: JP12/JP15/JP16			SPEAKER		Keylock	
AT Power Supply (default)		JP12: 1-2 & 3-4 JP15: 1-2 JP16: Open	Connect the cable of speakers to this jumper		Connect keyboard lock switch to this jumper	
ATX Power Supply		JP12: Open JP15: Open JP16: Close				
ATX Power Supply On/Off Switch: PW/SW						
Connect your power switch to this jumper (momentary switct type).			TB Led		PRT	
CE Test Jumper Pins: JP6/JP7/JP11			Connect your Turbo led to this jumper.		printer cable header	
These connectors are reserved for the CE test. If you run into any problems during the CE test, unplug these jumper pins and try again.						

Default I/O Settings

PORT	I/O Address	IRQ	Functionality
LPT1	378H	7	ECP + EPP
COM1	3F8H	4	—
COM2	2F8H	3	—

Note: If the default I/O settings conflict with those of other I/O cards, such as soundcards you will have to adjust the settings of one of them. The default settings for the onboard I/O can be changed in the BIOS setup. Enter BIOS Setup by pressing <Delete> key during boot-up. The I/O settings can be found under “Integrated Peripherals”.