



T h e S o u l O f C o m p u t e r T e c h n o l o g y

**Product Model: SL-75KV/75KV-X**  
**Manual Revision : V1.0**  
**Release Date : June 2000**

## **USER NOTICE**

This Users Guide & Technical Reference is for assisting system manufacturers and end-users in setting up and installing the mainboard.

Every effort has been made to ensure that the information in this manual is accurate. Soltek Computer Inc. is not responsible for printing or clerical errors. Information in this document is subject to change without notice and does not represent a commitment on the part of Soltek Computer Inc.

No part of this manual may be reproduced, transmitted, translated into any language in any form or by any means, electronic or mechanical, including photocopying and recording, for any purpose without the express written permission of Soltek Computer Inc.

Companies and products mentioned in this manual are for identification purpose only. Product names appearing in this manual may or may not be registered trademarks or copyrights of their respective companies.

Soltek computer inc. Provides this manual "As is " without warranty of any kind, either express or implied, including but not limited to the implied warranties or conditions of merchantability or fitness for a particular purpose. In no event shall Soltek computer inc. Be liable for any loss or profits, loss of business, loss of use or data, interruption of business, or for indirect, special, incidental, or consequential damages of any kind, even if Soltek computer inc. Has been advised of the possibility of such damages arising from any defect or error in this manual or product.

**Copyright © 2000 Soltek Computer Inc. All Rights Reserved.**

- AMD Athlon Thunderbird™, and Duron™ processors are trademarks of AMD Corporation.
- VIA, KT-133, VT8363 and VT82C686A are trademarks of VIA Corporation.
- Norton AntiVirus, Norton Ghost are trademarks of Symantec Corporation.

# **SOLTEK AROUND THE WORLD**

## **SOLTEK COMPUTER INC.**

---

Address : 7F, No. 306-3, Ta-Tung Rd, Sec.1, Hsi-Chin, Taipei-Hsien, Taiwan, R.O.C.  
Telephone : 886-2-2642-9060  
Fax : 886-2-2642-9065  
E-mail : [sashia@soltek.com.tw](mailto:sashia@soltek.com.tw)  
Web site : <http://www.soltek.com.tw>

## **SOLTEK KOREA INC.**

---

Address : 1002, Chungjin Bldg. 53-5 Wonhyo-Ro, 3-Ka, Yongsan-Ku Seoul 140-113, Korea  
Telephone : 82-2-32717400  
Fax : 82-2-32717405  
E-mail : [soltek@nuri.net](mailto:soltek@nuri.net)

## **MOKA HOLDING B.V.**

---

Address : De Run 4428 5503 LR Veldhoven, the Netherlands  
Telephone : 31-402-556150  
Fax : 31-402-546006

## **SOUL TECHNOLOGY EUROPE B.V.**

---

Address : Sydneystraat 52-54 3047 BP Rotterdam, the Netherlands  
Telephone : 31-10-2457492  
Fax : 31-10-2457493

# C O N T E N T

## Chapter 1

<b>INTRODUCTION .....</b>	<b>6</b>
1-1 ITEM LIST CHECKUP .....	6
1-2 PROCESSOR .....	6
1-3 CHIPSET .....	6
1-4 MEMORY .....	7
1-5 BIOS .....	7
1-6 MULTI-I/O FUNCTION .....	7
1-7 FORM FACTOR .....	8
1-8 AC'97 CODEC FUNCTION .....	8
1-9 MISCELLANOUS .....	8
1-10.1 MOTHERBOARD LAYOUT --- 75KV .....	9
1-10.2 MOTHERBOARD LAYOUT --- 75KV-X .....	10
1-11 CHIPSET DIAGRAM .....	11

## Chapter 2

<b>HARDWARE SETUP .....</b>	<b>12</b>
2-1 CPU INSTALLATION .....	12
2-2 AMD SOCKET A (SOCKET 462) PROCESSOR .....	13
2-3 CPU FREQUENCY .....	14
2-4 JUMPER DEFINITIONS .....	15
2-5 CONNECTORS .....	19
2-5.1 J3 AND J4 .....	19
2-5.2 CHASSIS PANEL CONNECTOR .....	23
2-5.3 ATX POWER SUPPLY CONNECTOR .....	24
2-5.4 SECOND USB CONNECTOR .....	25
2-5.5 PS/2 MOUSE AND PS/2 KEYBOARD .....	26
2-5.6 IRQ DESCRIPTION .....	27
2-6 VOICE DIAGNOSIS TECHNOLOGY FOR 75KV-X .....	28

## Chapter 3

<b>SOFTWARE SETUP .....</b>	<b>29</b>
3-1 ABOUT SUPPORT CD .....	29
3-2 HARDWARE MONITOR INSTALLATION .....	29
3-3 VIA CHIPSET DRIVER INSTALLATION (4-IN-1 DRIVER) .....	31
3-4 AC'97 AUDIO CODEC INSTALLATION .....	35

## Chapter 4

<b>BIOS Setup .....</b>	<b>37</b>
4-1 INTRODUCE THE BIOS .....	37
4-2 WHAT IS BIOS SETUP .....	37
4-3 HOW TO RUN BIOS SETUP .....	37
4-4 WHAT IS CMOS .....	37
4-5 WHAT IS POST .....	38
4-6 BIOS UPGRADE .....	38
4-6.1 BEFORE UPGRADE BIOS .....	38
4-6.2 UPGRADE PROCESS .....	38
4-7 CMOS SETUP UTILITY .....	41
4-8 STANDARD CMOS SETUP .....	42
4-9 ADVANCED BIOS FEATURES .....	44
4-10 ADVANCED CHIPSET FEATURES .....	48
4-11 INTEGRATED PERIPHERALS .....	54
4-12 POWER MANAGEMENT SETUP .....	59
4-13 PNP / PCI CONFIGURATION .....	65
4-14 PC HEALTH STATUS .....	68
4-15 FREQUENCY/VOLTAGE CONTROL .....	69
4-16 LOAD FAIL-SAFE DEFAULTS .....	70
4-17 LOAD OPTIMIZED DEFAULTS .....	70
4-18 SET SUPERVISOR / USER PASSWORD .....	71
4-19 SAVE & EXIT SETUP .....	72
4-20 EXIT WITHOUT SAVING .....	72

# CHAPTER 1 INTRODUCTION

## 1-1 ITEM LIST CHECKUP

- Motherboard
- Support CD
- User's Manual
- 2-In-1 Bonus Pack CD
- 2-In-1 Bonus Pack Manual
- Temperature Sensor Cable
- ATA66 IDE Cable
- RS232 Cable

## 1-2 PROCESSOR

- Supports AMD Athlon Thunderbird™ 700MHz/ 750MHz/ 800MHz/ 850MHz/ 900MHz/ 950MHz/1.0GHz processors or higher.
- Supports AMD Athlon Duron™ 600MHz/ 650MHz/ 700MHz processors or higher.
- Supports 66MHz/ 100MHz/ 133MHz CPU Front Side Bus(FSB).
- Supports processor voltage auto-detect circuit.

## 1-3 CHIPSET

- KT133 Chipset: VT8363 system controller (552 pin BGA)and VT82C686A PCI to ISA bridge (352 pin BGA).
  - The VT8363 supports two 32-bit 3.3V / 5V system buses (one AGP and one PCI) that are synchronous / pseudo-synchronous to the CPU bus.
  - Single chip Athlon system controller with 64-bit Socket-A Athlon CPU, 64-bit system memory, 32-bit PCI and 32-bit AGP interfaces.
  - PCI-to-ISA bridge chip includes UltraDMA-33/66 EIDE, 4 USB Ports, Integrated Super-I/O, AC97 / MC97 link(for Audio and Modem support). Hardware Monitoring, Power Management, and Keyboard / PS2 Mouse Interfaces plus RTC / CMOS on chip.
  - Supports separately powered 3.3V (5V tolerant) interface to system memory, AGP, and PCI bus.

- 100MHz DDR(Double Data Rate) transfer on Athlon CPU address and data buses.
- Supports full AGP v2.0 capability for maximum bus utilization including 1x, 2x, and 4x mode transfers.
- Both Windows 95 VxD and Windows 98 / Windows 2000 miniport drivers are supported for interoperability with major AGP-based 3D and DVD-capable multimedia accelerators.

## **1-4 MEMORY**

- Supports PC133 and PC100 SDRAM and Virtual Channel Memory (VCM) up to 3 DIMMs.
- Supports up to 1.5GB memory space (256MB DRAM technology).
- The six banks of DRAM can be composed of an arbitrary mixture of 1M/ 2M/ 4M/ 8M/ 16M/ 32MxN DRAMs.
- Different DRAM types may be used in mixed combinations.
- 64-bit data width and 3.3V DRAM Interface.
- Concurrent CPU, AGP, and PCI access.

## **1-5 BIOS**

- Award BIOS.
- Supports Plug & Play (PnP).
- Flash Memory for easy upgrade.
- Supports Advanced Power Management (APM) Rev 1.2 function.
- Advanced Configuration Power Management Interface (ACPI) Rev 1.0 compliant.
- Year 2000 compliant.

## **1-6 MULTI-I/O FUNCTION**

- One floppy port supports up to 2.88MB.
- Provides 2 Built-In USB Ports. (Another 2 internal USB ports for extensible purpose require an optional USB connect cable)
- Ultra ATA33/66 bus master IDE supports up to 4 IDE devices (including ZIP/LS-120 floppy devices).
- 2x 16550A Built-In fast UART compatible serial port connectors.
- Built-In SPP/EPP/ECP parallel port connector.
- Built-In standard IrDA TX/RX header.
- Peripherals boot-up function with ATX power.

## 75KV/75KV-X

### 1-7 FORM FACTOR

- ATX form factor, 4 layers PCB.
- Motherboard size: 22.0cm x 30.5cm

### 1-8 AC'97 CODEC FUNCTION

- Adopts onboard AC'97 Audio Codec controller chip.

### 1-9 MISCELLANEOUS

- PCI 2.2 compliant, 32-bit 3.3V PCI interface with 5V tolerant inputs.
- Provides 5 PCI master slots, 1 ISA slot, 1 4xAGP PRO slot, and 3 DIMM slots.
- Clock Generator supports 1MHz linear clock setting.
- Provides DIP switch for easy adjusting.
- Supports SCSI, CD-ROM, ZIP/LS-120, and USB boot-up function.
- Supports Wake On LAN(WOL) boot-up function.
- Supports BIOS Writing Protection.
- Supports BIOS CPU Core Voltage setting. (optional)
- Supports Hardware Monitor function.
- Supports Voice Diagnosis Technology for easily debugging. (**75KV-X** only)
- Supports Suspend To RAM(STR) function.



# 1-10.1 MOTHERBOARD LAYOUT --- 75KV

• Default Setting: AMD Athlon Thunderbird™ 100MHz.

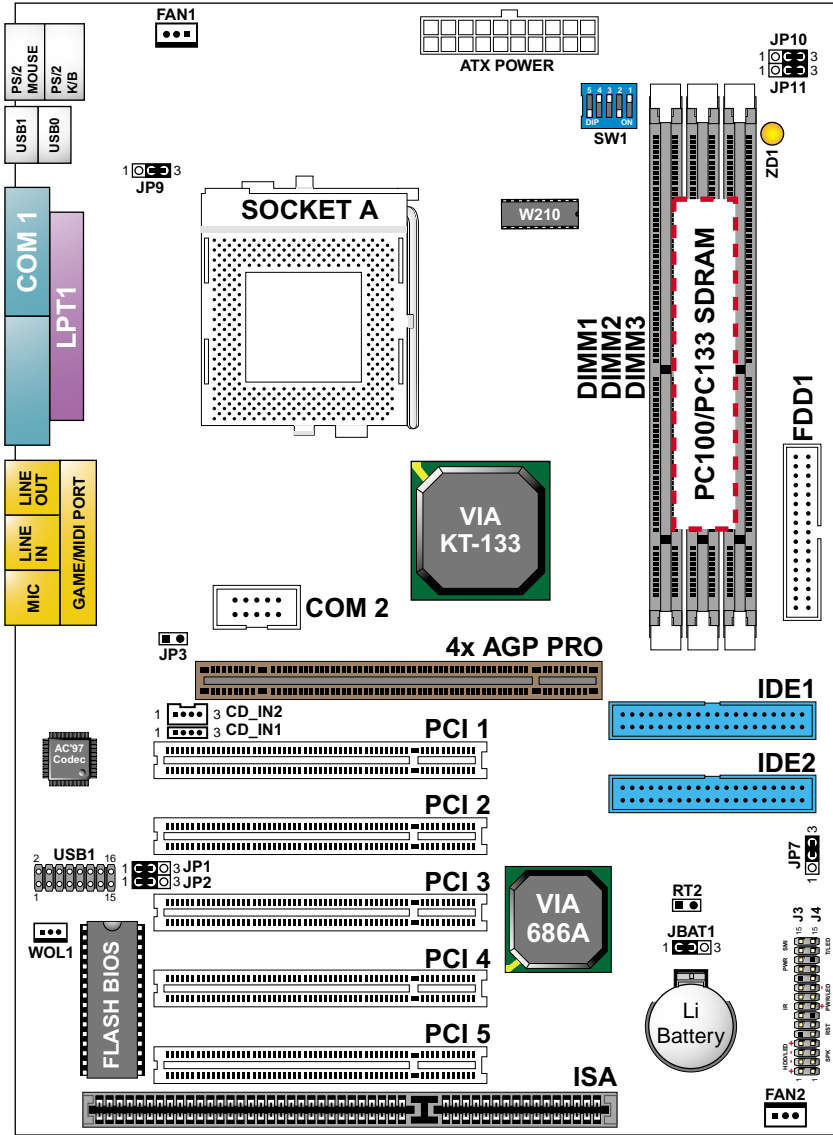

# 1-10.2 MOTHERBOARD LAYOUT --- 75KV-X

- Default Setting: AMD Athlon Thunderbird™ 100MHz.

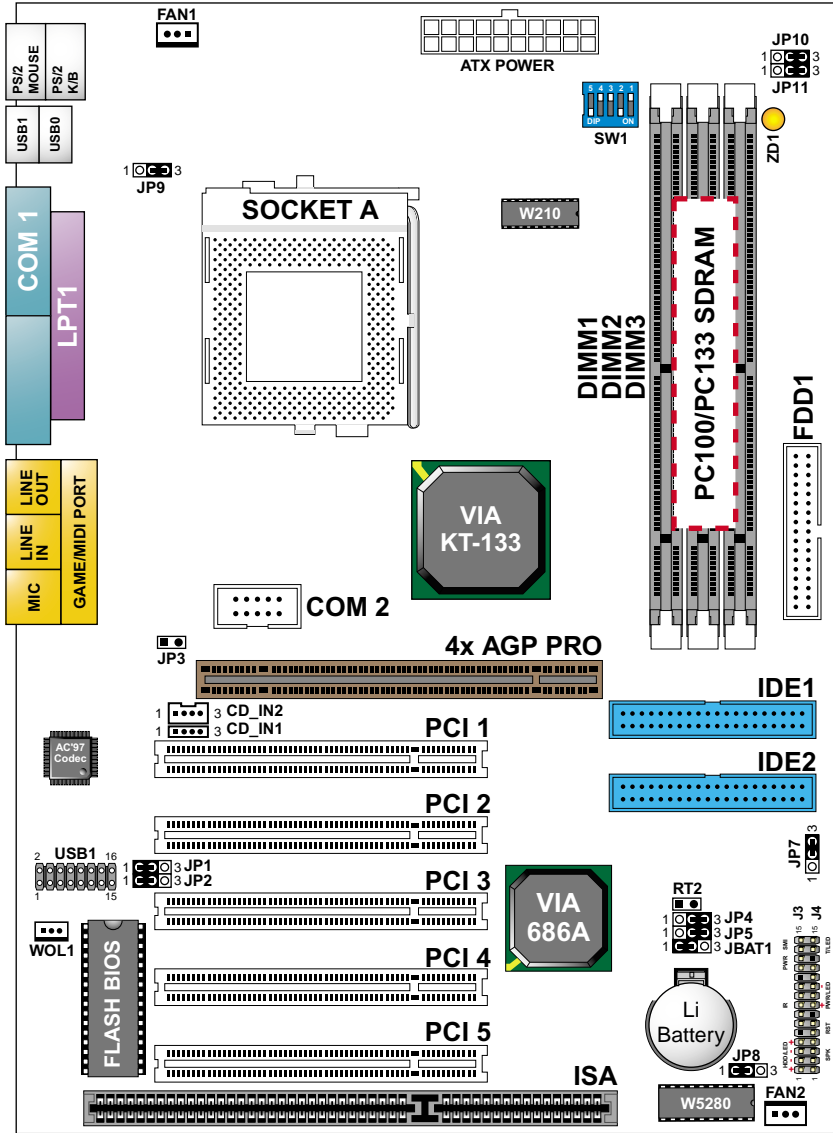

## 1-11 CHIPSET DIAGRAM

- The KT133 / VT8363 and VT82C686A chipset is a high performance, cost-effective and energy efficient system controller for the implementation of AGP / PCI / ISA desktop personal computer system based on 64-bit Socket-A (AMD Athlon) processors.

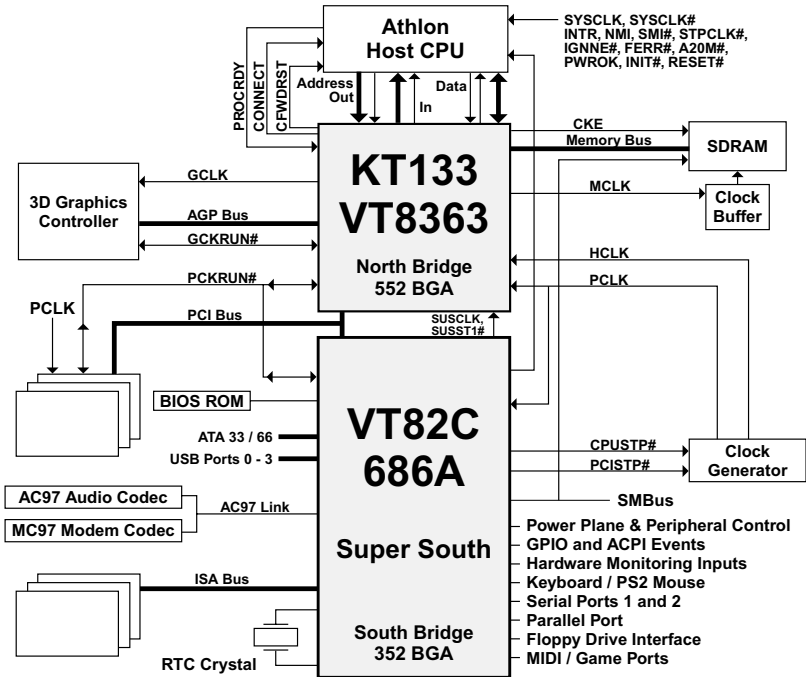

KT133 System Block Diagram Using the VT82C686A South Bridge

## CHAPTER 2 HARDWARE SETUP

### 2-1 CPU INSTALLATION

1. Pull the lever sideways away from the socket, and then raise the lever up to a 90-degree angle.

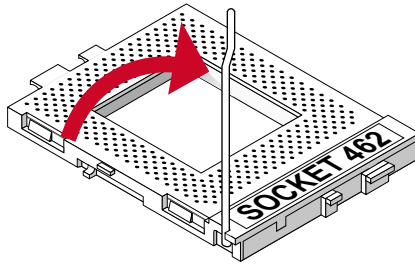

2. Take note of the red circle as below picture. While inserting the CPU into the socket, you can find out there is a definite pin orientation for CPU and socket.

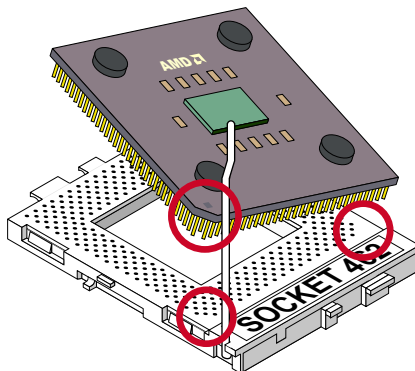

3. Make sure that the CPU position in the socket tightly, and then put the lever down to complete the CPU installation.

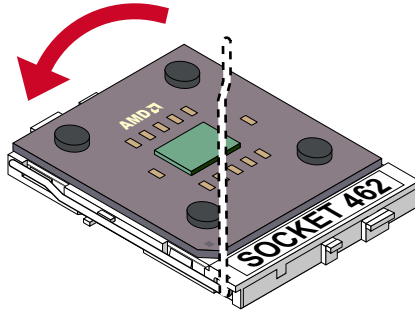

## 2-2 AMD SOCKET A (SOCKET 462) PROCESSOR

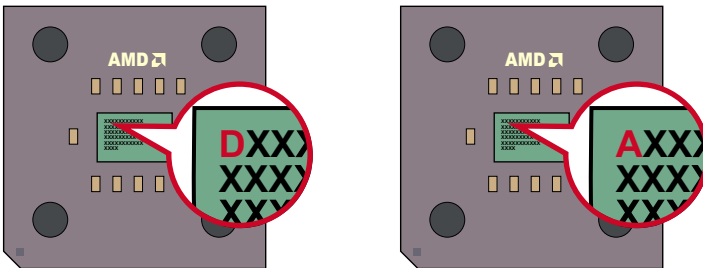

- 75KV/75KV-X motherboard works with AMD Athlon Thunderbird™ and Duron™ processor series. There is a simply way for user to distinguish between these two kinds of CPU. As the demonstration, you can see some little descriptions on the center of processor. Please pay attention to the first alphabert: the “D” represents AMD Athlon Duron™ processor, and the “A” represents AMD Athlon Thunderbird™ processor.

## 2-3 CPU FREQUENCY

SW1	CPU CLOCK	PCI CLOCK																								
<table border="1"> <tr><td>OFF</td><td>OFF</td><td>OFF</td><td></td></tr> <tr><td>ON</td><td>ON</td><td>ON</td><td>ON</td></tr> <tr><td></td><td></td><td></td><td></td></tr> <tr><td></td><td></td><td></td><td></td></tr> <tr><td></td><td></td><td></td><td></td></tr> <tr><td>5</td><td>4</td><td>3</td><td>2 1</td></tr> </table>	OFF	OFF	OFF		ON	ON	ON	ON													5	4	3	2 1	100MHz (default)	33.3MHz
OFF	OFF	OFF																								
ON	ON	ON	ON																							
5	4	3	2 1																							
<table border="1"> <tr><td>OFF</td><td>OFF</td><td>OFF</td><td></td></tr> <tr><td>ON</td><td>ON</td><td>ON</td><td>ON</td></tr> <tr><td></td><td></td><td></td><td></td></tr> <tr><td></td><td></td><td></td><td></td></tr> <tr><td></td><td></td><td></td><td></td></tr> <tr><td>5</td><td>4</td><td>3</td><td>2 1</td></tr> </table>	OFF	OFF	OFF		ON	ON	ON	ON													5	4	3	2 1	103MHz	34.3MHz
OFF	OFF	OFF																								
ON	ON	ON	ON																							
5	4	3	2 1																							
<table border="1"> <tr><td>OFF</td><td>OFF</td><td>OFF</td><td></td></tr> <tr><td>ON</td><td>ON</td><td>ON</td><td>ON</td></tr> <tr><td></td><td></td><td></td><td></td></tr> <tr><td></td><td></td><td></td><td></td></tr> <tr><td></td><td></td><td></td><td></td></tr> <tr><td>5</td><td>4</td><td>3</td><td>2 1</td></tr> </table>	OFF	OFF	OFF		ON	ON	ON	ON													5	4	3	2 1	105MHz	35.0MHz
OFF	OFF	OFF																								
ON	ON	ON	ON																							
5	4	3	2 1																							
<table border="1"> <tr><td>OFF</td><td>OFF</td><td>OFF</td><td></td></tr> <tr><td>ON</td><td>ON</td><td>ON</td><td>ON</td></tr> <tr><td></td><td></td><td></td><td></td></tr> <tr><td></td><td></td><td></td><td></td></tr> <tr><td></td><td></td><td></td><td></td></tr> <tr><td>5</td><td>4</td><td>3</td><td>2 1</td></tr> </table>	OFF	OFF	OFF		ON	ON	ON	ON													5	4	3	2 1	110MHz	36.7MHz
OFF	OFF	OFF																								
ON	ON	ON	ON																							
5	4	3	2 1																							
<table border="1"> <tr><td>OFF</td><td>OFF</td><td>OFF</td><td></td></tr> <tr><td>ON</td><td>ON</td><td>ON</td><td>ON</td></tr> <tr><td></td><td></td><td></td><td></td></tr> <tr><td></td><td></td><td></td><td></td></tr> <tr><td></td><td></td><td></td><td></td></tr> <tr><td>5</td><td>4</td><td>3</td><td>2 1</td></tr> </table>	OFF	OFF	OFF		ON	ON	ON	ON													5	4	3	2 1	112MHz	37.3MHz
OFF	OFF	OFF																								
ON	ON	ON	ON																							
5	4	3	2 1																							
<table border="1"> <tr><td>OFF</td><td>OFF</td><td>OFF</td><td></td></tr> <tr><td>ON</td><td>ON</td><td>ON</td><td>ON</td></tr> <tr><td></td><td></td><td></td><td></td></tr> <tr><td></td><td></td><td></td><td></td></tr> <tr><td></td><td></td><td></td><td></td></tr> <tr><td>5</td><td>4</td><td>3</td><td>2 1</td></tr> </table>	OFF	OFF	OFF		ON	ON	ON	ON													5	4	3	2 1	115MHz	38.3MHz
OFF	OFF	OFF																								
ON	ON	ON	ON																							
5	4	3	2 1																							
<table border="1"> <tr><td>OFF</td><td>OFF</td><td>OFF</td><td></td></tr> <tr><td>ON</td><td>ON</td><td>ON</td><td>ON</td></tr> <tr><td></td><td></td><td></td><td></td></tr> <tr><td></td><td></td><td></td><td></td></tr> <tr><td></td><td></td><td></td><td></td></tr> <tr><td>5</td><td>4</td><td>3</td><td>2 1</td></tr> </table>	OFF	OFF	OFF		ON	ON	ON	ON													5	4	3	2 1	120MHz	40.0MHz
OFF	OFF	OFF																								
ON	ON	ON	ON																							
5	4	3	2 1																							
<table border="1"> <tr><td>OFF</td><td>OFF</td><td>OFF</td><td></td></tr> <tr><td>ON</td><td>ON</td><td>ON</td><td>ON</td></tr> <tr><td></td><td></td><td></td><td></td></tr> <tr><td></td><td></td><td></td><td></td></tr> <tr><td></td><td></td><td></td><td></td></tr> <tr><td>5</td><td>4</td><td>3</td><td>2 1</td></tr> </table>	OFF	OFF	OFF		ON	ON	ON	ON													5	4	3	2 1	124MHz	31.0MHz
OFF	OFF	OFF																								
ON	ON	ON	ON																							
5	4	3	2 1																							
<table border="1"> <tr><td>OFF</td><td>OFF</td><td>OFF</td><td></td></tr> <tr><td>ON</td><td>ON</td><td>ON</td><td>ON</td></tr> <tr><td></td><td></td><td></td><td></td></tr> <tr><td></td><td></td><td></td><td></td></tr> <tr><td></td><td></td><td></td><td></td></tr> <tr><td>5</td><td>4</td><td>3</td><td>2 1</td></tr> </table>	OFF	OFF	OFF		ON	ON	ON	ON													5	4	3	2 1	133.3MHz	33.3MHz
OFF	OFF	OFF																								
ON	ON	ON	ON																							
5	4	3	2 1																							
<table border="1"> <tr><td>OFF</td><td>OFF</td><td>OFF</td><td></td></tr> <tr><td>ON</td><td>ON</td><td>ON</td><td>ON</td></tr> <tr><td></td><td></td><td></td><td></td></tr> <tr><td></td><td></td><td></td><td></td></tr> <tr><td></td><td></td><td></td><td></td></tr> <tr><td>5</td><td>4</td><td>3</td><td>2 1</td></tr> </table>	OFF	OFF	OFF		ON	ON	ON	ON													5	4	3	2 1	140MHz	35.0MHz
OFF	OFF	OFF																								
ON	ON	ON	ON																							
5	4	3	2 1																							
<table border="1"> <tr><td>OFF</td><td>OFF</td><td>OFF</td><td></td></tr> <tr><td>ON</td><td>ON</td><td>ON</td><td>ON</td></tr> <tr><td></td><td></td><td></td><td></td></tr> <tr><td></td><td></td><td></td><td></td></tr> <tr><td></td><td></td><td></td><td></td></tr> <tr><td>5</td><td>4</td><td>3</td><td>2 1</td></tr> </table>	OFF	OFF	OFF		ON	ON	ON	ON													5	4	3	2 1	150MHz	37.5MHz
OFF	OFF	OFF																								
ON	ON	ON	ON																							
5	4	3	2 1																							



**Premature wearing of the processor may result when overclocking. Be sure that the DIMM you use can handle the specified SDRAM MHz or else bootup will not be possible.**

## 2-4 JUMPER DEFINITIONS

- The figure below shows the location for the motherboard's jumper blocks.

### CAUTION

- Do not move the jumper with the power on. Always turn off the power and unplug the power cord from the computer before changing the jumper. Otherwise, the motherboard could be damaged.

FAN1/FAN2: ONBOARD FAN (12V)	
CPU FAN	FAN1 
SYSTEM FAN	FAN2 



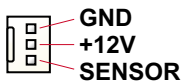

Those connectors support processor/system/chassis cooling fan with +12V. Those support three pin head connector. When connecting the wire to FAN connectors, user should give attention that the red wire is the positive and should be connected to the +12V, the black wire is Ground and should be connected to GND. If your motherboard has Hardware Monitor chipset on-board, you must use a specially designed fan with speed sensor to take advantage of this function.

For fans with fan speed sensor, every rotation of the fan will send out 2 pulses. System Hardware Monitor will count and report the fan rotation speed.







NOTE 1: Always consult vendor for proper CPU cooling fan.



NOTE 2: CPU FAN supports the FAN control. You can install PC Alert utility. This will automatically control the CPU FAN speed according to the actual CPU temperature.



JP1/JP2: USB PORT SELECT	
Redirect USB port 3 to USB 2 connector (default)	JP1  JP2 
Redirect USB port 3 to AGP	JP1  JP2 

JP3: FACTORY TEST	
Only for factory test.	JP3 



JP4/JP5: VOICE DIAGNOSTIC LANGUAGE SELECT	
Chinese Language	JP4 JP5 
English Language (default)	JP4 JP5 
Japanese Language	JP4 JP5 
Spanish Language	JP4 JP5 

**NOTE: The Voice Diagnosis Technology (JP4, JP5, and JP8) is only supported by 75KV-X motherboard.**









JP8: VD-TECH CONTROLLER CHIP	
Enabled (default)	JP8 
Disabled	JP8 

JP7: POWER LOST RESUME	
Normal (default)	JP7 
Enabled	JP7 

**This jumper allows you to use the switch of ATX power supply to control ON/OFF switch directly instead of using the power switch on the motherboard.**



JP9: USB POWER ON	
Disabled (default)	JP9 
Enabled	JP9 



JP10/JP11: VIO SELECT	
3.3V (default)	JP10  JP11 
3.4V	JP10  JP11 
3.5V	JP10  JP11 
3.6V	JP10  JP11 

VIO allows you to select the voltage supplied to the DRAM, chipset, AGP, PCI, and the CPU's I/O buffer. The default voltage (3.3V) should be used unless processor overclocking requires a higher voltage.

**NOTE! Using a higher voltage may help when overclocking but may result in the shortening of your computer components's life. It is strongly recommended that you leave this setting on its default.**

JBAT1: CLEAR CMOS DATA	
Clear CMOS Data	JBAT1 
Retain Data (default)	JBAT1 

A battery must be used to retain the motherboard configuration in CMOS RAM.

**NOTE :** You can clear CMOS by shorting 2-3 pin when the system is POWER OFF. Then, return to 1-2 pin position (default). It may damage the motherboard if clearing the CMOS in POWER ON status. Unplug the power cord from power supply before clearing CMOS will be a best bet for user.

WOL1 : WAKE ON LAN (WOL) FUNCTION	
Connect the Wake On LAN signal from LAN card to WOL1	WOL1 

**NOTE: For support WOL function, the ATX power supply must provide at least 5V / 720mA standby current.**

75KV/75KV-X

<b>CD_IN1/CD_IN2: CD-ROM AUDIO CONNECTOR</b>		
<b>PIN NO.</b>	<b>CD_IN1</b>	<b>CD_IN2</b>
<b>PIN 1</b>	<b>Left Channel</b>	<b>Left Channel</b>
<b>PIN 2</b>	<b>GND</b>	<b>GND</b>
<b>PIN 3</b>	<b>GND</b>	<b>Right Channel</b>
<b>PIN 4</b>	<b>Right Channel</b>	<b>GND</b>

## 2-5 CONNECTORS

- In this section we list all external connectors that user will use them.

### 2-5.1 J3 AND J4



HDD LED CONNECTOR	
PIN 1	+5V
PIN 2	HDD LED SIGNAL
PIN 3	HDD LED SIGNAL
PIN 4	+5V
DESCRIPTION	This connector supplies power to the cabinet's IDE activity LED. Read and write activity by devices connected to the Primary or Secondary IDE connector will cause the LED to light up.



INFRARED CONNECTOR	
PIN 6	INFRARED TRANSMIT SIGNAL
PIN 7	GND
PIN 8	INFRARED RECEIVE SIGNAL
PIN 9	NONE
PIN 10	+5V
DESCRIPTION	This connector supports an optional wireless transmitting and receiving infrared module. This module mounts to a small opening on system cases that support this feature. User must also configure the setting through BIOS program "Peripheral Setup" to select whether UART2 is directed for use with COM2 or IrDA. Use the five pins and connect a ribbon cable from the module to the motherboard's IR connector according to the pin definitions.

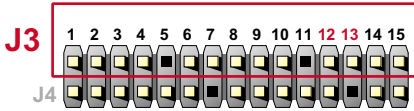

ATX POWER SWITCH	
PIN 12	ATX POWER SWITCH
PIN 13	GND
DESCRIPTION	<p>The system power is controlled by a momentary switch connected to this lead.</p> <p>Pressing the button once will switch the system between ON and SOFT OFF.</p> <p>Pushing the switch while in the ON mode for more 4 seconds will turn the system off.</p> <p>The system power LED shows the status of the system's power.</p>

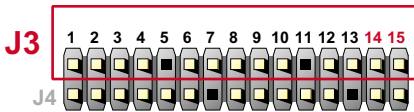

SMI CONNECTOR	
PIN 14	SMI(System Management Interrupt) SIGNAL
PIN 15	GND
DESCRIPTION	<p>This allows user to manually place the system into a suspend mode or "Green" mode, where system activity is decreased to save electricity and prolong the life of certain components when the system is not in use. This 2-pin connector connects to the case-mounted suspend switch. If you do not have a switch for the connector, you may use the "Turbo Switch".</p> <p>SMI is activated when it detects a short to open moment and therefore leaving it shorted will not cause any problems. This may require one or two presses depending on the position of the switch.</p> <p>Wake-Up can be controlled by settings in the BIOS but the keyboard will always allow wake-up (the SMI lead cannot wake up the system).</p>



75KV/75KV-X



SUSPEND LED	
PIN 14	SUSPEND LED SIGNAL
PIN 15	GND
DESCRIPTION	Connect to Suspend indicator light.

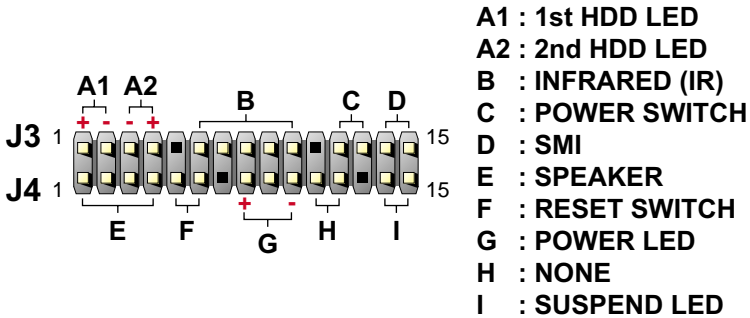

## 2-5.2 CHASSIS PANEL CONNECTOR

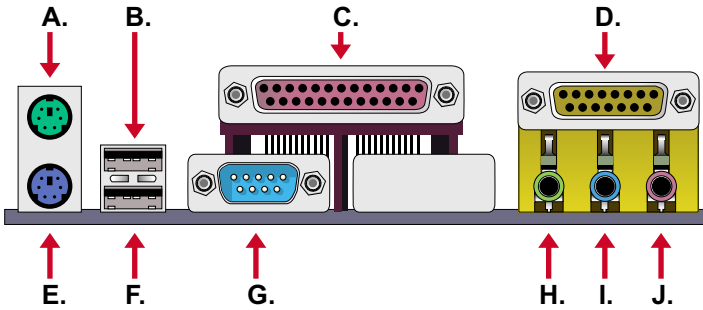

- A : PS/2 MOUSE PORT
- B : USB 0 PORT
- C : LPT 1 PORT
- D : GAME/MIDI PORT
- E : PS/2 KEYBOARD PORT
- F : USB 1 PORT
- G : COM 1 PORT
- H : LINE OUT/SPEAK OUT PORT
- I : LINE IN
- J : MICROPHONE

### 2-5.3 ATX POWER SUPPLY CONNECTOR

- This connector connects to an ATX power supply. The plug from the power supply only inserts in an orientation because of the different hole sizes. Find the proper orientation and push down firmly making sure that all pins are aligned.
- Reminding that your power supply should support at least 10mA on the 5V standby voltage. It may cause an difficulty to power on the system if the power supply can't support the load.
- **For Wake On LAN function, the power supply should support at least 720mA current.**

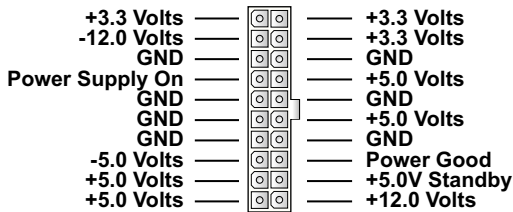



## 2-5.4 SECOND USB CONNECTOR

- This motherboard provides 4 sets of USB port. Besides 2 sets of them can be connected directly by USB devices, the others are built-in onboard for user to extend the USB function.
- **NOTE:** User can order the 2nd USB connector from your motherboard dealer and vendor only.

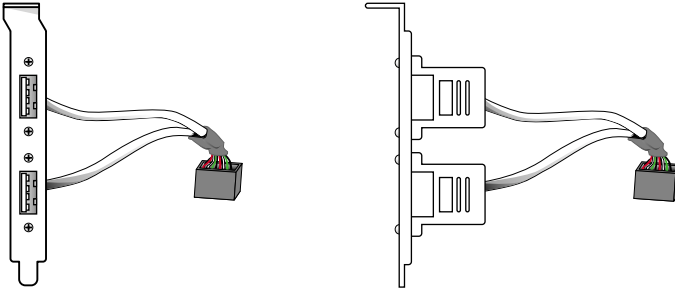

2nd USB Connector (Optional)

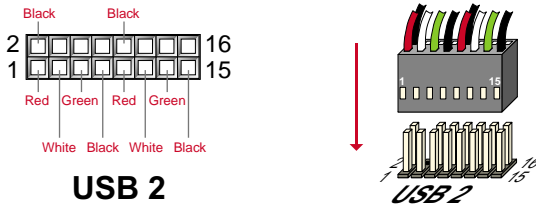

- When plugging the USB connector to USB2 port, user can see each color of wires to determine which is first pin.

PIN	SIGNAL	PIN	SIGNAL
PIN 1	Vcc (Red)	PIN 2	GND (Black)
PIN 3	DO- (White)	PIN 4	N/A
PIN 5	DO+ (Green)	PIN 6	N/A
PIN 7	GND (Black)	PIN 8	N/A
PIN 9	Vcc (Red)	PIN 10	GND (Black)
PIN 11	D1- (White)	PIN 12	N/A
PIN 13	D1+ (Green)	PIN 14	N/A
PIN 15	GND (Black)	PIN 16	N/A

## 2-5.5 PS/2 MOUSE AND PS/2 KEYBOARD

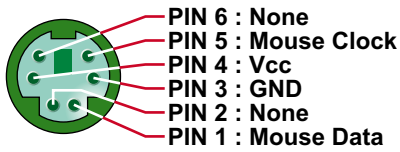

**PS/2 MOUSE**

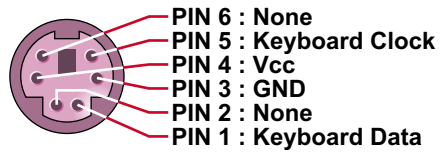

**PS/2 KEYBOARD**

## 2-5.6 IRQ DESCRIPTION

IRQ	Function Description	Priority
IRQ 0	System Timer	1
IRQ 1	Keyboard Controller	2
IRQ 2	Programmable Interrupt	N/A
IRQ 3	Serial Port (COM 2)	11
IRQ 4	Serial Port (COM 1)	12
IRQ 5		13
IRQ 6	Floppy Disk Controller	14
IRQ 7	Parallel Port (LPT1)	15
IRQ 8	Real Time Clock (RTC)	3
IRQ 9		4
IRQ 10		5
IRQ 11		6
IRQ 12	PS/2 Mouse Port	7
IRQ 13	Coprocessor	8
IRQ 14	Primary IDE Channel	9
IRQ 15	Secondary IDE Channel	10

- Both ISA and PCI expansion cards may require IRQs. System IRQs are available to cards installed in the ISA expansion bus first, then any remaining IRQs are available to PCI cards. Currently, there are two types of ISA cards.
- The original ISA expansion card design, now referred to as “Legacy” ISA card, requires that you configurate the card’s jumpers manually and then install it in any available slot on the ISA bus. To see a map of your used and free IRQs in Windows 98, the *Control Panel* in *My Computer*, contains a *System* icon, which gives you a *Device Manager* tab. Double-Clicking on a specific hardware device gives you a *Resources* tab which shows the Interrupt number and address. Double-Clicking *Computers* to see all the interrupts and addresses for your system. Make sure that no two devices use the same IRQ or your computer will experience problems when those two devices are in use at the same time.

## 2-6 VOICE DIAGNOSIS TECHNOLOGY FOR 75KV-X

- The Voice Diagnostic Function provides user an indispensable assistance on troubleshooting while assembling your computer components. If there is any conflict or other latent problem triggers a boot-up failure, this new VD-TECH technology will voice you realistically where the conflict/problem is, then user can remove the malfunction quickly.
- This function mainly provides 4 languages and their contents as following table:

<b>English Voice Content</b>
<ol style="list-style-type: none"> <li>1. No memory module</li> <li>2. Please check memory module</li> <li>3. Please clear CMOS setting</li> <li>4. Please check the Video adapter</li> <li>5. Please check hard disk cable or setting</li> </ol>
<b>國語語音内容</b>
<ol style="list-style-type: none"> <li>1. 未安裝記憶體</li> <li>2. 請檢查記憶體</li> <li>3. 請清除 CMOS 設定</li> <li>4. 請檢查顯示卡</li> <li>5. 請檢查硬碟接線及設定</li> </ol>
<b>El Contenido Español de la Voz</b>
<ol style="list-style-type: none"> <li>1. No hay modulo de memoria</li> <li>2. Por favor, chequea el modulo de memoria</li> <li>3. Por favor, borra CMOS setting</li> <li>4. Por favor, chequea la tarjeta de video</li> <li>5. Por favor, chequea el cable o la instalacion del disco duro</li> </ol>
<b>日本語音内容</b>
<ol style="list-style-type: none"> <li>1.メモリーないじゃん（メモリーがありません）</li> <li>2.メモリーだめだめ（メモリーをチェックして下さい）</li> <li>3.CMOS だめっす？（CMOSの内容をクリアして下さい）</li> <li>4.VGA どう？（ビデオカードをチェックして下さい）</li> <li>5.ハードディスクつながってる？ （HDDケーブル又は設定をチェックして下さい）</li> </ol>

## CHAPTER 3 SOFTWARE SETUP

### 3-1 ABOUT SUPPORT CD

- In support CD, it contains most informations for user's requirement, such as Acrobat Reader, BIOS, User's full version Manual, Driver, Hardware Monitor(if motherboard supports this function), Patch, and Utilities etc,. User can browse the CD and get further details in regard of our motherboard. Of course, welcome to vendor's website for the newest release.

### 3-2 HARDWARE MONITOR INSTALLATION



Step 1:

- Please put the support CD attached to motherboard into the CD-ROM drive.
- When appears a welcome window as left screen, then user should choose **"Install Driver"**



Step 2:

- Click on the **"VIA Chipset Driver"**.

## 75KV/75KV-X



Step 3:

- Click on the “**Hardware Monitor Utility**”.

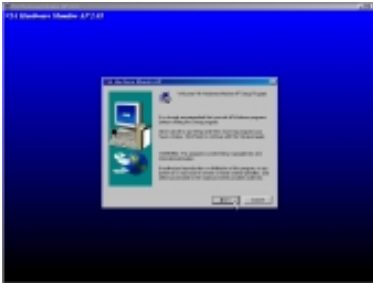

Step 4:

- Press **Next** button to continue.

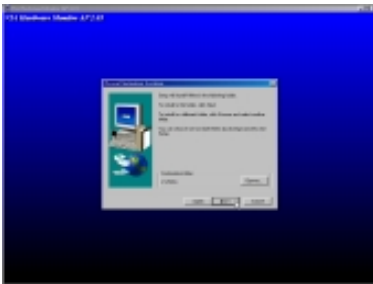

Step 5:

- The default destination is **C:\VIAhm**, then press **Next** button to continue.

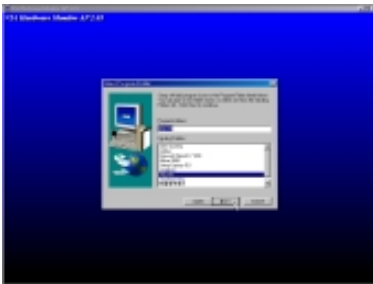

Step 6:

- Press **Next** button to finish the Hardware Monitor setup process.

### 3-3 VIA CHIPSET DRIVER INSTALLATION (4-IN-1 DRIVER)



Step 1:

- Please put the support CD attached to motherboard into the CD-ROM drive.
- When appears a welcome window as left screen, then user should choose “**Install Driver**”



Step 2:

- Click on the “**VIA Chipset Driver**”.

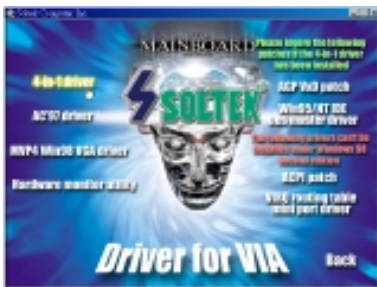

Step 3:

- Click on the “**4-in-1 driver**”.

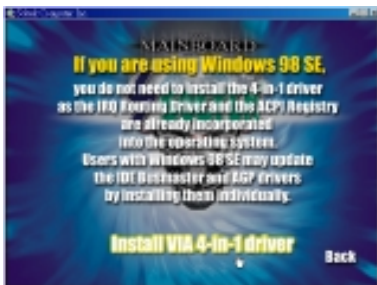

Step 4:

- Click on the “**Install via 4-in-1 driver**” to continue.

## 75KV/75KV-X

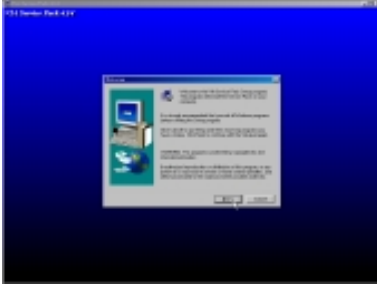

Step 5:

- Press **Next** button to continue.

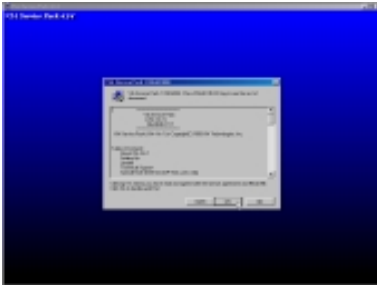

Step 6:

- Click "Yes" to continue.

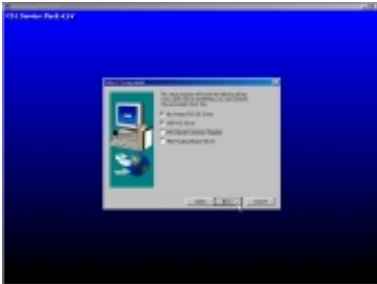

Step 7:

- Press select the checkbox as below:
  - **Bus Master PCI IDE Driver**
  - **AGP VxD Driver**
  - VIA Chipset Function's Registry
  - IRQ Routing Miniport Driver

NOTE: In Windows 95/98, user doesn't need to add "VIA Chipset Function's Registry" and "IRQ Routing Miniport Driver" items.

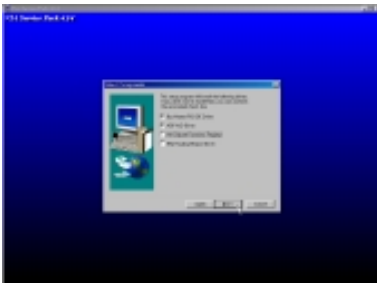

Step 8:

- Click "**Install**" and press **Next** button to continue.



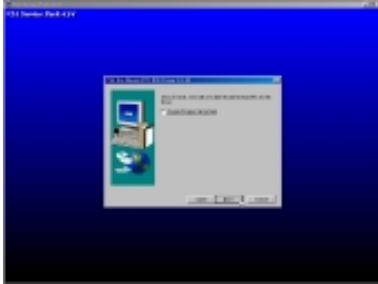

Step 9:

- We recommend user to leave “**Enable/Disable [Ultra] DMA**” checkbox empty.

NOTE: Whether select this item or not, user needs to enable the Hard Disk DMA function in Control Panel manually. (For further details, please refer to next page)

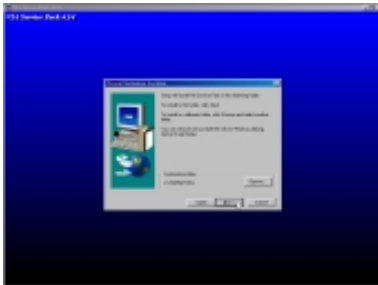

Step 10:

- The default setup destination is **C:\VIADMATool**, press **Next** button to continue.

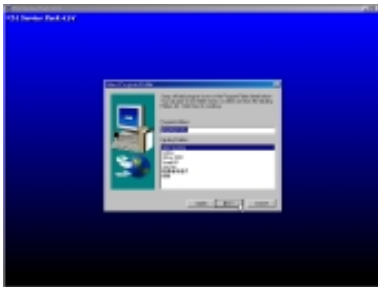

Step 11:

- Press **Next** button to continue.

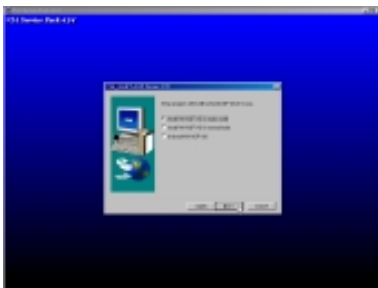

Step 12:

- Select “**Install VIA AGP VxD**” in turbo mode and press **Next** button to continue.

## 75KV/75KV-X

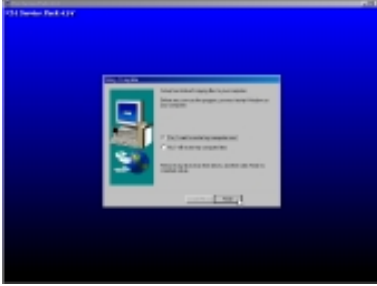

Step 13:

- After all the setup process is finished, please restart your computer by clicking on **Finish**.

## About Hard Disk DMA Function

Last but not least, user must enable the Hard Disk DMA function. The process is below:

1. **[Start] --> [Setting] --> [Control Panel] --> [System] --> [Device Manager]**.
2. In Device Manager, select **[Disk Drivers] --> [GENERIC IDE TYPEXX]**.
3. Select **[Properties]** for GENERIC IDE TYPEXX.
4. In Properties, select **[Settings]**.
5. In Option item, select the DMA checkbox.
6. Restart your computer.

### 3-4 AC'97 AUDIO CODEC INSTALLATION



Step 1:

- Please put the support CD attached to motherboard into the CD-ROM drive.
- When appears a welcome window as left screen, then user should choose "**Install Driver**"

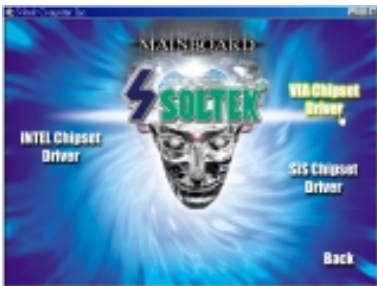

Step 2:

- Click on the "**VIA Chipset Driver**".



Step 3:

- Click on the "**AC'97 driver**".

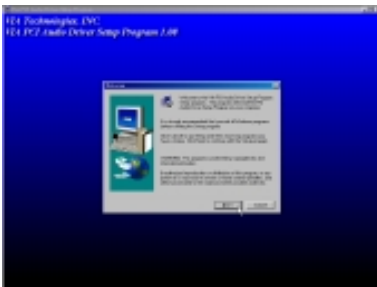

Step 4:

- Press **Next** button to continue.

## 75KV/75KV-X

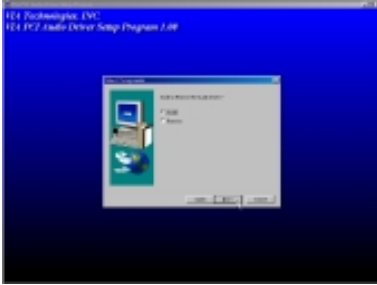

Step 5:

- When asking you install or remove the audio driver, please select “**Install**” and press **Next** button to continue.

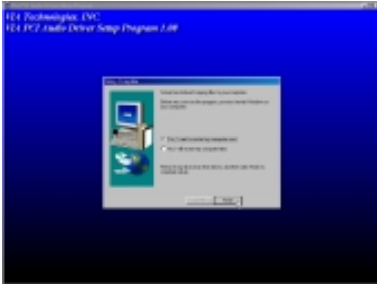

Step 6:

- It's recommended for user to restart the computer after the audio driver is finished. Please select “**Yes, I want to restart my computer now**”.

# CHAPTER 4

## BIOS SETUP

### 4-1 INTRODUCE THE BIOS

- BIOS stands for Basic Input Output System. It is sometimes called ROM BIOS because it is stored in a Read-Only Memory(ROM) chip on the motherboard. BIOS is the first program to run when you turn on your computer.
- BIOS performs the following functions:
  1. Initializing and testing hardware in your computer(a process called “POST”, for Power On Self Test).
  2. Loading and running your operating system.
  3. Helping your operating system and application programs to manage your PC hardware by means of a set of routines called BIOS Run-Time Service.

### 4-2 WHAT IS BIOS SETUP

- Setup is an interactive BIOS program that you need to run when:
  1. Changing the hardware on your system. (for example: installing a new Hard Disk etc.,)
  2. Modifying the behavior of your computer. (for example: changing the system time or date, or turning special features on or off etc.,)
  3. Enhancing your computer’s behavior. (for example: speeding up performance by turning on shadowing or caching)

### 4-3 HOW TO RUN BIOS SETUP

- One way of running SETUP is to press a special function key or key combination during POST, before the operating system is loaded during POST, the BIOS usually displays a prompt such as:

Press DEL to enter SETUP

### 4-4 WHAT IS CMOS

- CMOS is a special kind of memory maintained by a battery after you turn your computer off. The BIOS uses CMOS to store the settings you selected in SETUP. The CMOS also maintains the internal clock. Every time you turn on your computer, the BIOS Looks in CMOS for the settings you se-

## **75KV/75KV-X**

lected and configures your computer accordingly. If the battery charge runs too low, the CMOS content will be lost and POST will issue a “CMOS invalid” or “CMOS checksum invalid” message. If this happens, you may have to replace the battery. After the battery is replaced, the proper settings will need to be stored in SETUP.

## **4-5 WHAT IS POST**

- POST is an acronym for Power On Self Test. It's a traditional name for the routines that the BIOS uses to test and initializes the devices on your system when the PC is powered on. Its meanings has grown to include anything the BIOS does before the operating system is started. Each of POST routines is assigned a POST code, an unique number which is sent to I/O port 080h before the routine is executed.

## **4-6 BIOS UPGRADE**

- Motherboards incorporate the system BIOS in a Flash memory component. Flash BIOS allows user upgrades without the need to replace an EPROM component.
- The upgrade utility fits on a floppy diskette and provides the capability to save, verify, and update the system BIOS. The upgrade utility can be run from a hard disk drive or a network drive, but no memory managers can be installed during upgrades.

### **4-6.1 BEFORE UPGRADE BIOS**

- It is recommended that you save a copy of the original motherboard BIOS along with a Flash EPROM Programming utility(AWDFLASH.EXE) to a bootable floppy disk in case you need to reinstall the BIOS later.

### **4-6.2 UPGRADE PROCESS**

- “AWDFLASH.EXE” is a Flash EPROM Programming utility that updates the BIOS by uploading a new BIOS file to the programmable flash ROM on the motherboard. This file only works in DOS mode. To determine the BIOS version, check the release date displayed on the top of your screen during bootup. Newer dates represents a newer BIOS file.

**Create a Boot Floppy** (using a DOS system to create the bootable floppy)

- Place an unformatted floppy diskette in the floppy drive and format the floppy using the /S option.

Example: format a: /s

- Alternatively, place a formatted floppy in the floppy drive and use the “sys” command.

Example: sys a:

**Create the BIOS Upgrade Floppy Diskette**

- Download both the newest BIOS file and AWDFLASH.EXE file via motherboard maker’s website.
- The BIOS file you downloaded will be a \*.bin format.
- Copy those two indispensable files to a bootable formatted floppy diskette.

Example: copy awdf flash.exe a:

Example: copy \*.bin a:

**Upgrading the system BIOS**

- Place the bootable floppy containing the BIOS into Drive A: of the system that you want to upgrade and boot the system while the floppy diskette is in the drive.
- When booting is finished, type awdf flash \*.bin /sn/py/cc/r and then press <Enter> to run BIOS upgrade program. (\*.bin depends on your motherboard model and version code)

The parameters of AWDFLASH.EXE

/sn: No original BIOS backup

/py: Program flash memory

/cc: Clear CMOS data after programming

/r : Reset system after programming

**NOTE:** User can type AWDFLASH /? to get further details about parameters. Wrong usage of parameter will damage the BIOS information, so that we strongly recommend user to leave parameters away unless you realize their function.

## 75KV/75KV-X

- Then appears a program window as below:

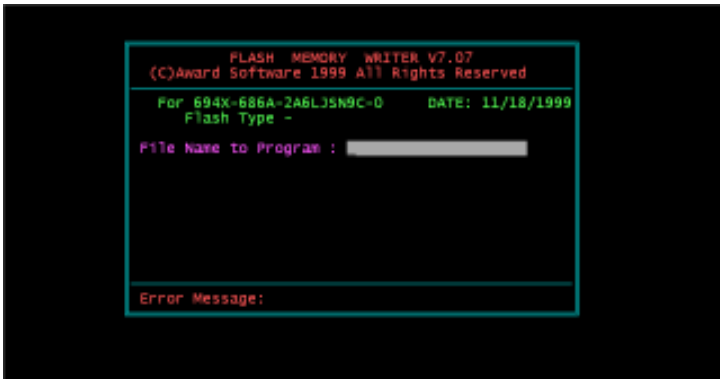

- After upgraded, the system will reboot itself automatically.
- **NOTE:** You will see a message “**CMOS checksum error - Default loaded**” during booting the system. Please press <Del> to run BIOS program, then reload “**LOAD SETUP DEFAULTS**” and save this change.



## 4-7 CMOS SETUP UTILITY

- This VIA KT-133 motherboard comes with the AWARD BIOS from AWARD Software Inc. Enter the Award BIOS program Main Menu by:

1. Turn on or reboot your system. After a series of diagnostic checks, the following message will appear:

**PRESS <DEL> TO ENTER SETUP**

2. Press the <DEL> key and the main program screen will appear as follows.

CMOS Setup Utility - Copyright (C) 1984 - 2000 Award Software

<ul style="list-style-type: none"> <li>▶ Standard CMOS Features</li> <li>▶ Advanced BIOS Features</li> <li>▶ Advanced Chipset Features</li> <li>▶ Integrated Peripherals</li> <li>▶ Power Management Setup</li> <li>▶ PnP/PCI Configurations</li> <li>▶ PC Health Status</li> </ul>	<ul style="list-style-type: none"> <li>▶ Frequency/Voltage Control</li> <li>Load Fail-Safe Defaults</li> <li>Load Optimized Defaults</li> <li>Set Supervisor Password</li> <li>Set User Password</li> <li>SAVE &amp; EXIT SETUP</li> <li>EXIT WITHOUT SAVING</li> </ul>
Esc : Quit F10 : Save & Exit Setup	↑↓→← : Select Item (Shift) F2 : Change Color
Time, Date, Hard Disk Type...	

3. Using the arrows on your keyboard, select an option, and press <Enter>. Modify the system parameters to reflect the options installed in your system.
4. You may return to the Main Menu anytime by pressing <ESC>.
5. In the Main Menu, "SAVE AND EXIT SETUP" saves your changes and reboots the system, and "EXIT WITHOUT SAVING" ignores your changes and exits the program.

## 4-8 STANDARD CMOS SETUP

- Standard CMOS Setup allows you to record some basic system hardware configuration and set the system clock and error handling. You only need to modify the configuration values of this option when you change your system hardware configuration or the configuration stored in the CMOS memory gets lost or damaged.

Run the STANDARD CMOS SETUP as following:

1. Choose "STAND CMOS SETUP" from the Main Menu and a screen with a list of option will appear:

CMOS Setup Utility - Copyright (C) 1984-2000 Award Software  
Standard CMOS Features

Date (mm:dd:yy)	Thu, Dec 30 1999	Item Help
Time (hh:mm:ss)	9 : 52 : 15	Menu Level ▶
▶ IDE Primary Master	Press Enter 13022 MB	
▶ IDE Primary Slave	Press Enter None	
▶ IDE Secondary Master	Press Enter None	
▶ IDE Secondary Slave	Press Enter None	
Drive A	1.44M, 3.5 in.	
Drive B	None	
Video	EGA/VGA	
Halt On	All,But Keyboard	
Base Memory	640K	
Extended Memory	31744K	
Total Memory	32768K	

↑ ↓ → ← : Move Enter: Select +/-/PU/PD: Value F10: Save ESC: Exit F1: General Help  
F5: Previous Values F6: Fail-Safe Defaults F7: Optimized Defaults

2. Use one of the arrow keys to move between options and modify the selected options by using PgUp / PgDn / + / - keys.

**Date (mm:dd:yy)** Set the current date and time.  
**Time (hh:mm:ss)**

**Primary / Secondary Master / Slave** This field records the specifications for all non-SCSI hard disk drives installed in your system. Refer to the respective documentation on how to install the drives.

**Drive A / Drive B** Set this field to the type(s) of floppy disk drive(s) installed in your system. The choices are:  
360KB, 5.25in.,  
1.2MB, 5.25in.,  
720KB, 3.5in.,  
1.44MB, 3.5in., (default)  
2.88MB, 3.5in.,  
None.

**Video** Set this field to the type of video display card installed in the system. The choices are:  
Monochrome,  
Color 40x25,  
VGA / EGA, (default)  
Color 80x25.

**Halt On** Set this warning feature for the type of errors that will cause the system to halt. The choices are:  
No Errors,  
All, But Keyboard,  
All, But Diskette,  
All, But Disk / Key.

3. Press <ESC> to return to the Main Menu when you finish setting up all items.

## 4-9 ADVANCED BIOS FEATURES

- ADVANCED BIOS FEATURS allows you to improve your system performance or set up system features according to your preference.

Run the ADVANCED BIOS FEATURES as following:

1. Choose "ADVANCED BIOS FEATURES" from the Main Menu and a screen with a list of option will appear:
2. Use one of the arrow keys to move between options and modify the selected options by using PgUp / PgDn / + / - keys. An explanation of the <F> keys follows:

<F1>: "Help" gives oions available for each item.

<Shift> + <F2>: Change color.

<F5>: Get the previous values. These values are the values with which the user started in the current session.

<F6>: Load all options with the BIOS default values.

<F7>: Load all options with the Setup default values.

CMOS Setup Utility - Copyright (C) 1984-2000 Award Software  
Advanced BIOS Features

		Item Help
Virus Warning	Disabled	Menu Level ▶
CPU Internal Cache	Enabled	
External Cache	Enabled	
CPU L2 Cache ECC Checking	Enabled	
Quick Power On Self Test	Enabled	
First Boot Device	Floppy	
Second Boot Device	HDD-0	
Third Boot Device	CDROM	
Boot Other Device	Enabled	
Swap Floppy Drive	Disabled	
Boot Up Floppy Seek	Disabled	
Boot Up NumLock Status	On	
Gate A20 Option	Fast	
Typematic Rate Setting	Disabled	
× Typematic Rate (Chars/Sec)	6	
× Typematic Delay (Msec)	250	
Security Option	Setup	
OS Select For DRAM > 64MB	Non-OS2	
Video BIOS Shadow	Enabled	
C8000-CBFFF Shadow	Disabled	
CC000-CFFFF Shadow	Disabled	
D0000-D3FFF Shadow	Disabled	
D4000-D7FFF Shadow	Disabled	
D8000-DBFFF Shadow	Disabled	
DC000-DFFFF Shadow	Disabled	

↑ ↓ ← → : Move Enter: Select +/-/PU/PD: Value F10: Save ESC: Exit F1: General Help  
F5: Previous Values F6: Fail-Safe Defaults F7: Optimized Defaults

**Virus Warning** Enabled: Activates automatically when the system boots up causing a warning message to appear if there is anything attempting to access the boot sector or hard disk partition table.

Disabled: No warning message will appear when there is something attempting to access the boot sector or hard disk partition table.

**NOTE:** *Many diagnostic (or boot manager) programs which attempt to access the boot sector table can cause the above warning message. If you will be running such a program, we recommend that you disable the virus protection first.*

**CPU Internal Cache** Choose Enabled (default) or Disabled. This option allows you to enable or disable the CPU's internal cache.

**External Cache** Choose Enabled (default) or Disabled. This option allows you to enable or disable the external cache.

**CPU L2 Cache ECC Checking** This item allows you to enable/disable CPU L2 Cache ECC checking.  
The choice: Enabled, Disabled.

**Quick Power On Self Test** Choose Enabled (default) or Disabled. This option allows you to speed up the Power-On Self-Test routine.

**First/Second/Third/Other Boot Device** The BIOS attempts to load the operating system from the devices in the sequence selected in these items.  
The choice: Floppy, LS/ZIP, HDD, SCSI, CDROM, Disabled.

**Swap Floppy Drive** Choose Enabled or Disabled (default). This option swaps floppy drive assignments when it is enabled.

**Boot Up Floppy Seek** Enabled (default): During POST, BIOS checks the track number of the floppy disk drive to see whether it is 40 or 80 tracks.  
Disabled: During POST, BIOS will not check the track number of the floppy disk drive.

- Boot Up NumLock Status** Choose ON (default) or OFF. This option lets user activates the NumLock function at boot-up.
- Gate A20 Option** Choose Normal or Fast (default). This option allows the RAM to access the memory above 1MB by using the fast gate A20 line.
- Typematic Rate Setting** Choose Enabled or Disabled (default). Enable this option to adjust the keystroke repeat rate.
- Typematic Rate (Chars / Sec)** Range between 6 (default) and 30 characters per second. This option controls the speed of repeating keystrokes.
- Typematic Delay (Msec)** Choose 250 (default), 500, 750 and 1000. This option sets the time interval for displaying the first and the second characters.
- Security Option** Choose System or Setup (default). This option prevents unauthorized system boot-up or use of BIOS setup.
- OS Select For DRAM > 64MB** Non-OS/2 (default): For Non-OS/2 system.  
OS: For OS/2 operating system.
- Video BIOS Shadow** Enabled copies Video BIOS to shadow RAM for improving performance.  
The choice: Enabled (default), Disabled.
- C8000-CBFFF to DC000-DFFFF Shadow** These options are used to shadow other expansion card ROMs.

3. Press <ESC> to return to the Main Menu when you finish setting up all items.

## 4-10 ADVANCED CHIPSET FEATURES

- ADVANCED CHIPSET FEATURES allows you to change the values of chipset registers. These registers control the system options.

Run the ADVANCED CHIPSET FEATURES as following:

1. Choose "ADVANCED CHIPSET FEATURES" from the Main Menu and a screen with a list of option will appear:
2. Use one of the arrow keys to move between options and modify the selected options by using PgUp / PgDn / + / - keys. An explanation of the <F> keys follows:

<F1>: "Help" gives options available for each item.

<Shift> + <F2>: Change color.

<F5>: Get the previous values. These values are the values with which the user started in the current session.

<F6>: Load all options with the BIOS default values.

<F7>: Load all options with the Setup default values.



CMOS Setup Utility - Copyright (C) 1984-2000 Award Software  
Advanced Chipset Features

		Item Help
Bank 0/1 DRAM Timing	SDRAM 8/10ns	Menu Level ▶
Bank 2/3 DRAM Timing	SDRAM 8/10ns	
Bank 4/5 DRAM Timing	SDRAM 8/10ns	
SDRAM Cycle Length	3	
DRAM Clock	Host CLK	
DRAM Drive Strength	Auto	
× DRAM Drive Value	2F	
Memory Hole	Disabled	
PCI Master Pipeline Req	Enabled	
P2C/C2P Concurrency	Enabled	
Fast R-W Turn Around	Disabled	
System BIOS Cacheable	Disabled	
Video RAM Cacheable	Disabled	
AGP Aperture Size	64M	
AGP Driving Control	Auto	
AGP Driving Value	DA	
AGP Fast Write	Disabled	
K7 CLK_CTL Select	Optimal	
OnChip USB	Enabled	
OnChip USB 2	Enabled	
USB Keyboard Support	Disabled	
OnChip Sound	Auto	
OnChip Modem	Auto	
CPU to PCI Write Buffer	Enabled	
PCI Dynamic Bursting	Disabled	
PCI Master 0 WS Write	Enabled	
PCI Delay Transaction	Disabled	
PCI#2 Access #1 Retry	Disabled	
AGP Master 1 WS Write	Disabled	
AGP Master 1 WS Read	Disabled	
Memory Parity/ECC Check	Disabled	
CPU Voltage Regulator	Default	

↑ ↓ → ← : Move Enter: Select +/-/PU/PD: Value F10: Save ESC: Exit F1: General Help  
F5: Previous Values F6: Fail-Safe Defaults F7: Optimized Defaults

## 75KV/75KV-X

- Bank 0/1 2/3 4/5 DRAM Timing** This item allows you to select the value in this field, depending on whether the board has paged DRAMs or EDO (Extended Data Output) DRAMs.  
The choice: EDO 50ns,  
EDO 60ns,  
Slow,  
Medium,  
Fast,  
Turbo.
- SDRAM Cycle Length Time** You can select CAS latency time in HCLKs of 2/2 or 3/3. The system board designer should have set the values in this field, depending on the DRAM installed. Do not change the values in this field unless you change specifications of the installed DRAM or the installed CPU.
- DRAM Clock** This item allows you to control the DRAM speed.  
The choice: Host Clock, HCLK+33M.
- DRAM Drive Strength** Leave this item with Auto mode.  
The choice: Auto, Manual.
- DRAM Drive Value** When “DRAM Drive Strength” is set to “Auto”, this item will be unable to be selected. We don’t recommend user to adjust this item.
- Memory Hole** In order to improve performance, certain space in memory is reserved for ISA cards. This memory must be mapped into the memory space below 16MB.  
The choice: 15M-16M, Disabled.
- PCI Master Pipeline Req** Use default setting.
- P2C/C2P Concurrency** This item allows you to enable/disable the PCI to CPU, CPU to PCI concurrency.  
The choice: Enabled, Disabled.
- Fast R-W Turn Around** This item controls the DRAM timing. It allows you to enable / disable the fast read / write turn around.  
The choice: Enabled, Disabled.

- System BIOS Cacheable** Choose Enabled or Disabled (default). When enabled, the access to the system BIOS ROM addressed at F0000H - FFFFFH is cached.
- Video RAM Cacheable** Choose Enabled or Disabled (default). When enabled, the access to the VGA RAM addressed is cached.
- AGP Aperture Size** Choose 4, 8, 16, 32, 64 (default), 128 or 256 MB. Memory mapped and graphics data structures can reside in a Graphics Aperture. This area is like a linear buffer. BIOS will automatically report the starting address of this buffer to the O.S.
- AGP Driving Control** This item allows you to adjust the AGP driving force. Choose Manual to key in a AGP Driving Value in the next selection. This field is recommended to set in Auto for avoiding any error in your system.  
The choice: Manual, Auto.
- AGP Driving Value** This item allows you to adjust the AGP driving force.  
The choice: Min=0000 ~ Max=00FF.
- AGP Fast Write** This item will enable the AGP model into fast write mode.
- K7 CLK\_CTL Select** Use this item to specify the clock control for ramp rate. Select default for a defaulted time value, and optimal for optimum time value which depends on different CPU ratio.  
The choice: Enabled, Disabled.
- OnChip USB/USB2** This should be enabled if our system has a USB installed on the system board and you wish to use it. Even when so equipped, if you add a higher performance controller, you will need to disable this feature.  
The choice: Enabled, Disabled.
- USB Keyboard Support** Enabled: Enable function when the USB keyboard is being used.  
Disabled (default): When the AT keyboard is being used, choose disabled.

**OnChip Sound** Enabled (default): Turn on AC'97 codec chip controller.  
Disabled: Turn off AC'97 codec chip controller or user can plug external add-on sound card.

**OnChip Modem** Enabled: Turn on MC99 feature.  
Disabled (default): Turn off AC'97 codec chip controller or user can connect external add-on modem.

**IDE HDD Block Mode** Choose Enabled (default) or Disabled. If your hard disk size is larger than 540MB, then choose Enabled. If you are using the IDE HDD AUTO DETECTION option, the BIOS will choose this option automatically.

**NOTE:** *Some older model HDDs do not provide this feature.*

**CPU to PCI Write Buffer** When this field is Enabled, writes from the CPU to the PCI bus are buffered, to compensate for the speed differences between the CPU and the PCI bus. When Disabled, the writes are not buffered and the CPU must wait until the write is complete before starting another write cycle.  
The choice: Enabled, Disabled.

**PCI Dynamic Bursting** When Enabled, every write transaction goes to the write buffer. Burstable transactions then burst on the PCI bus and nonburstable transactions don't.  
The choice: Enabled, Disabled.

**PCI / VGA Palette Snoop** Choose Enabled or Disabled (default). It determines whether or not the MPEG ISA cards can work with PCI / VGA.

**PCI Master 0 WS Write** When Enabled, writes to the PCI bus are executed with zero wait states.  
The choice: Enabled, Disabled.

**PCI Master 0 WS Read** When Enabled, reads to the PCI bus are executed with zero wait states.  
The choice: Enabled, Disabled.

**Memory Parity/ECC Check** This item enabled to detect the memory parity and Error Checking & Correcting.  
The choice: Enabled, Disabled.

**CPU Voltage Regulator** This item allows user to adjust the CPU Vcore voltage.  
The instant damage of CPU is due to the wrong Vcore voltage setting, so that we recommend that user should leave this item with Default setting unless you know how to adjust it.  
The choice: Default, -0.05V, -0.10V, +0.40V, +0.30V, +0.20V, +0.10V, +0.05V.

3. Press <ESC> to return to the Main Menu when you finish setting up all items.

## 4-11 INTEGRATED PERIPHERALS

- INTEGRATED PERIPHERALS option allows you to get some informations inside your system when it is working.

Run the INTEGRATED PERIPHERALS as following:

1. Choose “INTEGRATED PERIPHERALS” from the Main Menu and a screen with a list of option will appear:

CMOS Setup Utility - Copyright (C) 1984-2000 Award Software  
Integrated Peripherals

		Item Help
On-Chip Primary PCI IDE	Enabled	Menu Level ▶
On-Chip Secondary PCI IDE	Enabled	
IDE Prefetch Mode	Enabled	
Primary Master PIO	Auto	
Primary Slave PIO	Auto	
Secondary Master PIO	Auto	
Secondary Slave PIO	Auto	
Primary Master UDMA	Auto	
Primary Slave UDMA	Auto	
Secondary Master UDMA	Auto	
Secondary Slave UDMA	Auto	
Init Display First	PCI Slot	
IDE HDD Block Mode	Enabled	
Onboard FDC Controller	Enabled	
Onboard Serial Port 1	3F8/IRQ4	
Onboard Serial Port 2	2F8/IRQ3	
UART 2 Mode	Standard	
× IR Function Duplex	Half	
× TX, RX inverting enable	No, Yes	
Onboard Parallel Port	378/IRQ7	
Onboard Parallel Mode	Normal	
× ECP Mode Use DMA	3	
× Parallel Port EPP Type	EPP1.7	
Onboard Legacy Audio	Enabled	
Sound Blaster	Disabled	
SB I/O Base Address	220H	
SB IRQ Select	IRQ 5	
SB DMA Select	DMA 1	
MPU-401	Disabled	
MPU-401 I/O Address	330-333H	
Game Port (200-207H)	Enabled	

↑ ↓ ← → : Move Enter: Select +/-/PU/PD: Value F10: Save ESC: Exit F1: General Help  
F5: Previous Values F6: Fail-Safe Defaults F7: Optimized Defaults

2. Use one of the arrow keys to move between options and modify the selected options by using PgUp / PgDn / + / - keys. An explanation of the <F> keys follows:

<F1>: "Help" gives options available for each item.

<Shift> + <F2>: Change color.

<F5>: Get the previous values. These values are the values with which the user started in the current session.

<F6>: Load all options with the BIOS default values.

<F7>: Load all options with the Setup default values.

**On-Chip Primary/  
Secondary PCI IDE** The chipset contains a PCI IDE interface with support from two IDE channels. Select Enabled to activate the first and/or the second IDE interface. Select Disabled to deactivate an interface if you install a primary and/or second add-on IDE interface.  
The choice: Enabled (default), Disabled.

**IDE Prefetch Mode** The onboard IDE drive interfaces supports IDE prefetching for faster drive accesses. If you install a primary and/or secondary add-in IDE interfaces, set this field to Disabled if the interface does not support prefetching.  
The choice: Enabled, Disabled.

**Primary** Choose Auto (default) or Mode 0~4. The BIOS will detect the HDD mode type automatically when you choose Auto. You need to set to a lower mode than  
**Master / Slave PIO** choose Auto. You need to set to a lower mode than  
**Secondary** Auto when your hard disk becomes unstable.  
**Master / Slave PIO** The choice: Auto, Mode 0, Mode 1, Mode 2, Mode 3, Mode 4.

**Primary** Ultra DMA/66 implementation is possible only if your  
**Master / Slave UDMA** IDE hard drive supports it and the operating environment includes a DMA drive and your system software  
**Secondary** both support Ultra DMA/66, select Auto to enable  
**Master / Slave UDMA** BIOS support.  
The choice: Auto, Disabled.

**Init Display First** This option allows you to decide to activate PCI Slot or AGP first.  
The choice: PCI Slot (default), AGP.

**IDE HDD Block Mode** Block mode is also called block transfer, multiple commands, or multiple sector read/write. If your IDE hard drive supports block mode (most new drives do), select Enabled for automatic detection of the optimal number of block read/write per sector the drive can support.  
The choice: Enabled, Disabled.



- Onboard FDC Controller** Select Enabled if your system has a floppy drive controller (FDC) installed on the system board and you want to use it. If you install add-in FDC or the system has no floppy drive, select Disabled in this field.  
The choice: Enabled, Disabled.
- Onboard Serial Port 1 / Port2** Select an address and corresponding interrupt for the first and second serial ports.  
The choice: 3F8/IRQ4, 2E8/IRQ3, 3E8/IRQ4, 2F8/IRQ3, Disabled, Auto.
- UART 2 Mode** This item allows you to select which mode for the Onboard Serial Port 2.  
The choice: Standard, HPSIR, ASKIR
- IR Function Duplex** This item allows you to select the IR half / full duplex function.  
The choice: Half, Full.
- TX, RX inverting enable** This item allows you to enable the TX, RX inverting which depends on different H/W requirement. This field is not recommended to change its default setting for avoiding any error in your system.  
The choice: "No, No", "No, Yes"(default), "Yes, No", "Yes, Yes".
- Onboard Parallel Port** This item allows you to determine onboard parallel port controller I/O address setting.  
The choice: 378H/IRQ7, 278H/IRQ5, 3BC/IRQ7, Disabled.
- Parallel Port Mode** Select an operating mode for the onboard parallel (printer) port. Select Normal, Compatible, or SPP unless you are certain your hardware and software both support one of the other available modes.  
The choice: SPP, EPP, ECP, ECP + EPP.
- ECP Mode Use DMA** Select a DMA channel for the parallel port for use during ECP mode.  
The choice: 3, 1.

## 75KV/75KV-X

**Parallel Port EPP Type** Select EPP port type 1.7 or 1.9  
The choice: EPP1.7, 1.9.

**Onboard Legacy Audio** This field controls the onboard audio.

- Sound Blaster
- SB I/O Base Address
- SB IRQ Select
- SB DMA Select
- MPU-401
- MPU-401 I/O Address
- Game Port (200-207H)

3. Press <ESC> to return to the Main Menu when you finish setting up all items.

## 4-12 POWER MANAGEMENT SETUP

- POWER MANAGEMENT SETUP allows you to set the system's power saving functions.

Run the POWER MANAGEMENT SETUP as following:

1. Choose "POWER MANAGEMENT SETUP" from the Main Menu and a screen with a list of option will appear:

CMOS Setup Utility - Copyright (C) 1984-2000 Award Software  
Power Management Setup

ACPI Function	Enabled	Item Help
▶ Power Management	Press Enter	Menu Level ▶
ACPI Suspend Type	S1(POS)	
PM Control by APM	Yes	
Video Off Option	Suspend -> Off	
Video Off Method	V/H SYNC+Blank	
MODEM Use IRQ	3	
Soft-Off by PWRBTN	Instant-Off	
▶ Wake Up Events	Press Enter	

↑↓→←:Move Enter:Select +/-PU/PD:Value F10:Save ESC:Exit F1:General Help  
F5:Previous Values F6:Fail-Safe Defaults F7:Optimized Defaults

2. Use one of the arrow keys to move between options and modify the selected options by using PgUp / PgDn / + / - keys. An explanation of the <F> keys follows:

<F1>: "Help" gives options available for each item.

<Shift> + <F2>: Change color.

<F5>: Get the previous values. These values are the values with which the user started in the current session.

<F6>: Load all options with the BIOS default values.

<F7>: Load all options with the Setup default values.

**ACPI Function** Enabled: Turn on ACPI function.  
 Disabled (default): Turn off ACPI function.

- Press <Enter> on the Power Management item, then there is a list of it appears for you to choose further setting.

CMOS Setup Utility - Copyright (C) 1984-2000 Award Software  
 Power Management

Power Management	User Define	Item Help
HDD Power Down	Disable	Menu Level ▶
Doze Mode	Disable	
Suspend Mode	Disable	

↑ ↓ → ←:Move Enter:Select +/-/PU/PD:Value F10:Save ESC:Exit F1:General Help  
 F5:Previous Values F6:Fail-Safe Defaults F7:Optimized Defaults

**Power Management** This category allows you to select the type (or degree) of power saving and is directly related to the following modes:

**HDD Power Down** When enabled and after the set time of system inactivity, the hard disk drive will be powered down while all other devices remain active.

**Doze Mode** When enabled and after the set time of system inactivity, the CPU clock will run at slower speed while all other devices still operate at full speed.

**Suspend Mode** When enabled and after the set time of system inactivity, all devices except the CPU will be shut off.

**ACPI Suspend Type** This item will allow you to select the ACPI suspend type. You can select S3(STR) for suspending to DRAM or S1(POS) for power on suspend under Windows 98 ACPI mode.  
The choice: S1(POS), S3(STR).

**PM Control by APM** When enabled, an Advanced Power Management device will be activated to enhance the Max. Power Saving mode and stop the CPU internal clock, If Advanced Power Management (APM) is installed on your system, selecting Yes gives better power savings. If the Max. Saving is not enabled, this will be present to No.

**Video Off Option** When enabled, this feature allows the VGA adapter to operate in a power saving mode.

<b>Always On</b>	Monitor will remain on during power saving modes.
<b>Suspend --&gt; Off</b>	Monitor blanked when the systems enters the Suspend mode.
<b>Susp, Stby --&gt; Off</b>	Monitor blanked when the system enters either Suspend or Standby modes.

**Video Off Method** This determines the manner in which the monitor is blanked.

<b>V/H SYNC + Blank</b>	This selection will cause the system to turn off the vertical and horizontal synchronization ports and write blanks to the video buffer.
<b>Blank Screen</b>	This option only writes blanks to the video buffer.
<b>DPMS</b>	Select this option if your monitor supports the Display Power Management Signaling (DPMS) standard of the Video Electronics Standards to select video power management values.

**MODEM Use IRQ** This determines the IRQ in which the MODEM can use.  
The choice: 3, 4, 5, 7, 9, 10, 11, NA.

**75KV/75KV-X**

**Soft-Off by PWRBTN** Instant-Off (default): Turn off the system power at once after pushing the power button.  
 Delay 4 Sec: Turn off the system power 4 seconds after pushing the power button. (to meet PC97/98 spec)

- Press <Enter> on the Wake Up Events item, then there is a list of it appears for you to choose further setting.

CMOS Setup Utility - Copyright (C) 1984-2000 Award Software  
 Wake Up Events

VGA	OFF	Item Help
LPT & COM	LPT/COM	Menu Level ▶
HDD & FDD	ON	
PCI Master	OFF	
Wake Up On LAN/Ring	Disabled	
RTC Alarm Resume	Disabled	
Date (of Month)	0	
Resume Time (hh:mm:ss)	0 0 0	
Primary INTR	ON	
IRQ Activity Monitoring	Press Enter	

↑↓→←:Move Enter:Select +/-/PU/PD:Value F10:Save ESC:Exit F1:General Help  
 F5:Previous Values F6:Fail-Safe Defaults F7:Optimized Defaults

**VGA** When Enabled, you can set the VGA awakens the system

**LPT & COM** When On of LPT & COM, any activity from one of the listed system peripheral devices or IRQs wakes up the system.

**HDD & FDD** When On of HDD & FDD, any activity from one of the listed system peripheral devices wakes up the system.

**PCI Master** When On of PCI Master, any activity from one of the listed system peripheral devices wakes up the system.

- Wake Up On LAN/Ring** An input signal on the serial Ring Indicator (RI) line (in other words, an incoming call on the modem) awakens the system from a soft off state.  
The choice: Enabled, Disabled.
- RTC Alarm Resume** When Enabled, you can set the data and time at the which the RTC (Real Time Clock) alarm awakens the system from suspend mode.  
The choice: Disabled (default), Enabled.
- Date (of Month)** Set a certain date when RTC Alarm Resume option is Enabled to awaken the system. This option is concurrent with Resume Time option.
- Resume Time (hh:mm:ss)** Set a certain time when RTC Alarm Resume option is Enabled to awaken the system. This option is concurrent with Date option.
- Modem Ring Resume** An input signal on the serial Ring Indicator (RI) Line (in other words, an incoming call on the modem) Awakens the system from a soft off state.

## 75KV/75KV-X

The following is a list of IRQ's (Interrupt ReQuests), which can be exempted much as the COM ports and LPT ports above can. When an I/O device wants to gain the attention of the operating system, it signals this by causing an IRQ to occur. When the operating system is ready to respond to the request, it interrupts itself and performs the service. When set On, activity will neither prevent the system from going into a power management mode nor awaken it.

### CMOS Setup Utility - Copyright (C) 1984-2000 Award Software IRQ Activity Monitoring

		Item Help
IRQ 3 (COM2)	Enabled	Menu Level ▶
IRQ 4 (COM1)	Enabled	
IRQ 5 (LPT2)	Enabled	
IRQ 6 (Floppy Disk)	Enabled	
IRQ 7 (LPT1)	Enabled	
IRQ 8 (RTC Alarm)	Disabled	
IRQ 9 (IRQ2 Redir)	Disabled	
IRQ 10 (Reserved)	Disabled	
IRQ 11 (Reserved)	Disabled	
IRQ 12 (PS/2 Mouse)	Enabled	
IRQ 13 (Coprocessor)	Enabled	
IRQ 14 (Hard Disk)	Enabled	
IRQ 15 (Reserved)	Disabled	

↑ ↓ → ←: Move Enter: Select +/-/PU/PD: Value F10: Save ESC: Exit F1: General Help  
F5: Previous Values F6: Fail-Safe Defaults F7: Optimized Defaults

3. Press <ESC> to return to the Main Menu when you finish setting up all items.



## 4-13 PNP / PCI CONFIGURATION

- PNP/PCI CONFIGURATION allows you to set the system's power saving functions.

Run the PNP/PCI CONFIGURATION as following:

1. Choose "PNP/PCI CONFIGURATION" from the Main Menu and a screen with a list of option will appear:

CMOS Setup Utility - Copyright (C) 1984-2000 Award Software  
PnP/PCI Configurations

PNP OS Installed	No	Item Help
Reset Configuration Data	Disabled	Menu Level ▶
Resources Controlled By	Auto(ESCD)	
× IRQ Resources	Press Enter	
× DMA Resources	Press Enter	
PCI/VGA Palette Snoop	Disabled	
Assign IRQ For VGA	Enabled	
Assign IRQ For USB	Enabled	

↑↓→←:Move Enter:Select +/-/PU/PD:Value F10:Save ESC:Exit F1:General Help  
F5:Previous Values F6:Fail-Safe Defaults F7:Optimized Defaults

2. Use one of the arrow keys to move between options and modify the selected options by using PgUp / PgDn / + / - keys. An explanation of the <F> keys follows:

<F1>: "Help" gives options available for each item.

<Shift> + <F2>: Change color.

<F5>: Get the previous values. These values are the values with which the user started in the current session.

<F6>: Load all options with the BIOS default values.

<F7>: Load all options with the Setup default values.

**PNP OS Installed** Yes: OS supports Plug and Play function.  
 No (default): OS doesn't support Plug and Play function.

**NOTE:** BIOS will automatically disable all PnP resources except the boot device card when you select Yes on Non-PnP operating system.

**Reset Configuration Data** Choose Enabled or Disabled (default). Disabled **tains** PnP configuration data in BIOS and Enabled **resets** the PnP configuration data in BIOS.

**Resource Controlled By** Choose Manual (default) or Auto. The BIOS checks the IRQ / DMA channel number on the ISA and PCI card manually if you choose Manual and the IRQ / DMA channel number will be checked automatically if you choose Auto.

**IRQ Resources** Press Enter. Please refer to the below list.

CMOS Setup Utility - Copyright (C) 1984-2000 Award Software  
 IRQ Resources

IRQ-3 assigned to	PCI/ISA PnP	Item Help
IRQ-4 assigned to	PCI/ISA PnP	Menu Level ▶
IRQ-5 assigned to	PCI/ISA PnP	
IRQ-7 assigned to	PCI/ISA PnP	
IRQ-9 assigned to	PCI/ISA PnP	
IRQ-10 assigned to	PCI/ISA PnP	
IRQ-11 assigned to	PCI/ISA PnP	
IRQ-12 assigned to	PCI/ISA PnP	
IRQ-14 assigned to	PCI/ISA PnP	
IRQ-15 assigned to	PCI/ISA PnP	

↑ ↓ → ← : Move Enter: Select +/-/PU/PD: Value F10: Save ESC: Exit F1: General Help  
 F5: Previous Values F6: Fail-Safe Defaults F7: Optimized Defaults

**DMA Resources** Press Enter. Please refer to the below list.

CMOS Setup Utility - Copyright (C) 1984-2000 Award Software  
DMA Resources

DMA-0 assigned to	PCI/ISA PnP	Item Help
DMA-1 assigned to	PCI/ISA PnP	Menu Level ▶
DMA-3 assigned to	PCI/ISA PnP	
DMA-5 assigned to	PCI/ISA PnP	
DMA-6 assigned to	PCI/ISA PnP	
DMA-7 assigned to	PCI/ISA PnP	

↑↓→←:Move Enter:Select +/-/PU/PD:Value F10:Save ESC:Exit F1:General Help  
F5:Previous Values F6:Fail-Safe Defaults F7:Optimized Defaults

**PCI/VGA Palette Snoop** Leave this field at Disabled.  
The choice: Enabled, Disabled(default).

**Assign IRQ for VGA** Enabled (default): Add one IRQ to VGA controller.  
Disabled: Remove IRQ from USB controller. The system will have extra IRQ for other devices but the VGA controller will still not be disabled. (only IRQ was removed)

**Assign IRQ for USB** Enabled (default): Add one IRQ to USB controller.  
Disabled: Remove IRQ from USB controller. The system will have extra IRQ for other devices but the USB controller will still not be disabled. (only IRQ was removed)

3. Press <ESC> to return to the Main Menu when you finish setting up all items.

## 4-14 PC HEALTH STATUS

- This section helps you to get more information about your system including CPU temperature, FAN speed and voltage. It is recommended that you contact with your motherboard supplier to get proper value about your setting of the CPU temperature.

CMOS Setup Utility - Copyright (C) 1984-2000 Award Software  
PC Health Status

Current CPU Temp.	36°C/96°F	Item Help
Current System Temp.	°C/32°F	Menu Level ▶
Current CPUFAN1 Speed	5120 RPM	
Current CPUFAN2 Speed	0 RPM	
Vcore	1.53V	
2.5V	3.25V	
3.3V	3.28V	
5V	5.00V	
12V	11.76V	

↑↓→←:Move Enter:Select +/-/PU/PD:Value F10:Save ESC:Exit F1:General Help  
F5:Previous Values F6:Fail-Safe Defaults F7:Optimized Defaults

**Current CPU Temp.** Shows current CPU temperature.

**Current System Temp.** Shows current system temperature.

**Current CPUFAN1 Speed** Shows current CPUFAN1 speed. The fan must provide rotary pulse. (Normally these types of fan have a three-wire connector)

**Current CPUFAN2 Speed** Shows current CPUFAN2 speed. The fan must provide rotary pulse. (Normally these types of fan have a three-wire connector)

**Voltage** Shows power supply actual voltage value.

- Press <ESC> to return to the Main Menu when you finish setting up all items.

## 4-15 FREQUENCY/VOLTAGE CONTROL

CMOS Setup Utility - Copyright (C) 1984-2000 Award Software  
Frequency Control

Auto Detect DIMM/PCI Clk	Enabled	Item Help
Spread Spectrum Modulated	Disabled	Menu Level ▶
CPU Host Clock (CPU/PCI)	Default	
Method In Linear Funct.	Increase	
CPU HOST By Linear Funct.	0	

↑↓ → ←: Move Enter: Select +/-PU/PD: Value F10: Save ESC: Exit F1: General Help  
F5: Previous Values F6: Fail-Safe Defaults F7: Optimized Defaults

**Auto Detect DIMM/PCI CLK** This item allows you to enable/disable detect DIMM/PCI Clock.  
The choice: Enabled, Disabled.

**Spread Spectrum Modulated** This item allows you to enable/disable the spread spectrum modulate.  
The choice: Enabled, Disabled.

**CPU Host Clock (CPU/PCI)** This item allows you to select CPU/PCI frequency.  
The choice: Default, 100/33MHz, 103/34MHz, 105/35MHz, 112/37MHz, 115/38MHz, 120/40MHz, 124/41MHz.

**CPU HOST By Linear Funct.** The choice: 0, 1, 2, 3, 4, 5, 6, 7, 8, 9, 10, 11, 12, 13, 14, 15, 16, 17, 18, 19, 20, 21, 22, 23, 24, 25, 26, 27, 28.

- Press <ESC> to return to the Main Menu when you finish setting up all items.

## 4-16 LOAD FAIL-SAFE DEFAULTS

- When you press <Enter> on this item you get a confirmation dialog box with a message similar to:

```
" Load Fail-Safe Defaults (Y / N) ? N "
```

Pressing "Y" loads the BIOS default values for the most stable, minimal-performance system operations.

## 4-17 LOAD OPTIMIZED DEFAULTS

- When you press <Enter> on this item you get a confirmation dialog box with a message similar to:

```
" Load Optimized Defaults (Y / N) ? N "
```

Pressing "Y" loads the BIOS default values that are factory settings for optimal performance system operations.

## 4-18 SET SUPERVISOR / USER PASSWORD

- These two options allow you to set your system passwords. Normally, the supervisor has a higher ability to change the CMOS setup option than the user. The way to set up the passwords for both Supervisor and User are as follows:

1. Choose "Change Password" in the Main Menu and press <Enter>. The following message appears:

`"Enter Password : "`

2. The first time you run this option, enter your password up to 8 characters and press <Enter>. The screen does not display the entered characters.
3. After you enter the password, the following message appears prompting you to confirm the password:

`"Confirm Password : "`

4. Enter the same password "exactly" as you just typed again to confirm the password and press <Enter>.
5. Move the cursor to Save & Exit Setup to save the password.
6. If you need to delete the password entered before, choose the Supervisor Password and press <Enter>. It will delete the password that you had before.
7. Move the cursor to Save & Exit Setup to save the option you did, otherwise the old password will still be there the next time you turn your system on.
8. Press <Enter> to exit to the Main Menu.

**NOTE:** *If you forget or lose the password, the only way to access the system is to clear the CMOS RAM. All setup information will be lost and you need to run the BIOS setup program again.*

#### 4-19 SAVE & EXIT SETUP

- SAVE & EXIT SETUP allows you to save all modifications you have specified into the CMOS memory. Highlight this option on the Main Menu and the following message appears:

```
"SAVE to CMOS and EXIT (Y/N) ? Y "
```

Press <Enter> key to save the configuration changes.

#### 4-20 EXIT WITHOUT SAVING

- EXIT WITHOUT SAVING option allows you to exit the Setup Utility without saving the modifications that you have specified. Highlight this option on the Main Menu and the following message appears:

```
"Quit Without Saving (Y/N) ? N "
```

You may change the prompt to "Y" and press <Enter> key to leave this option .