

# Preface

## Copyright

This publication, including all photographs, illustrations and software, is protected under international copyright laws, with all rights reserved. Neither this manual, nor any of the material contained herein, may be reproduced without written consent of the author.

Version 1.0b

## Disclaimer

The information in this document is subject to change without notice. The manufacturer makes no representations or warranties with respect to the contents hereof and specifically disclaims any implied warranties of merchantability or fitness for any particular purpose. The manufacturer reserves the right to revise this publication and to make changes from time to time in the content hereof without obligation of the manufacturer to notify any person of such revision or changes.

## Trademark Recognition

Microsoft, MS-DOS and Windows are registered trademarks of Microsoft Corp.

MMX, Pentium, Pentium-II, Pentium-III, Celeron are registered trademarks of Intel Corporation.

Other product names used in this manual are the properties of their respective owners and are acknowledged.

## Federal Communications Commission (FCC)

This equipment has been tested and found to comply with the limits for a Class B digital device, pursuant to Part 15 of the FCC Rules. These limits are designed to provide reasonable protection against harmful interference in a residential installation. This equipment generates, uses, and can radiate radio frequency energy and, if not installed and used in accordance with the instructions, may cause harmful interference to radio communications. However, there is no guarantee that interference will not occur in a particular installation. If this equipment does cause harmful interference to radio or television reception, which can be determined by turning the equipment off and on, the user is encouraged to try to correct the interference by one or more of the following measures:

- Reorient or relocate the receiving antenna.
- Increase the separation between the equipment and the receiver.
- Connect the equipment onto an outlet on a circuit different from that to which the receiver is connected.
- Consult the dealer or an experienced radio/TV technician for help.

Shielded interconnect cables and a shielded AC power cable must be employed with this equipment to ensure compliance with the pertinent RF emission limits governing this device. Changes or modifications not expressly approved by the system's manufacturer could void the user's authority to operate the equipment.

## Declaration of Conformity

This device complies with part 15 of the FCC rules. Operation is subject to the following conditions:

- This device may not cause harmful interference, and
- This device must accept any interference received, including interference that may cause undesired operation.

## Canadian Department of Communications

This class B digital apparatus meets all requirements of the Canadian Interference-causing Equipment Regulations.

Cet appareil numérique de la classe B respecte toutes les exigences du Règlement sur le matériel brouilleur du Canada.

## About the Manual

The manual consists of the following:

|   |   |
|---|---|
| <b>Chapter 1</b><br><b>Introducing the Mainboard</b>    | Describes features of the mainboard, and provides a shipping checklist.<br><br>Go to ⇒ page 1 |
| <b>Chapter 2</b><br><b>Installing the Mainboard</b>     | Describes installation of mainboard components.<br><br>Go to ⇒ page 7                         |
| <b>Chapter 3</b><br><b>Using BIOS</b>                   | Provides information on using the BIOS Setup Utility.<br><br>Go to ⇒ page 27                  |
| <b>Chapter 4</b><br><b>Using the Mainboard Software</b> | Describes the mainboard software.<br><br>Go to ⇒ page 52                                      |

---

## TABLE OF CONTENTS

---

|   |             |
|---|-------------|
| <b>Preface</b>                                  | <b>i</b>    |
| <b>Features and Packing List Translations</b>   | 錯誤! 尚未定義書籤。 |
| <b>CHAPTER 1</b>                                | <b>1</b>    |
| <b>Introducing the Mainboard</b>                | <b>1</b>    |
| <i>Introduction</i> .....                       | 1           |
| <i>Checklist</i> .....                          | 1           |
| Standard Items .....                            | 1           |
| <i>Features</i> .....                           | 2           |
| <i>Choosing a Computer Case</i> .....           | 4           |
| <i>Mainboard Components</i> .....               | 5           |
| <b>CHAPTER 2</b>                                | <b>7</b>    |
| <b>Installing the Mainboard</b>                 | <b>7</b>    |
| <i>Safety Precautions</i> .....                 | 7           |
| <i>Quick Guide</i> .....                        | 7           |
| <i>Installing the Mainboard in a Case</i> ..... | 8           |
| <i>Checking Jumper Settings</i> .....           | 8           |
| Setting Jumpers .....                           | 8           |
| Checking Jumper Settings .....                  | 9           |
| Jumper Settings .....                           | 9           |
| Connecting Case Components .....                | 10          |
| Front Panel Connector .....                     | 12          |
| <i>Installing Hardware</i> .....                | 13          |
| Installing the Processor .....                  | 13          |
| Installing Memory Modules .....                 | 16          |
| Installing a Hard Disk Drive/CD-ROM .....       | 17          |
| Installing a Floppy Diskette Drive .....        | 19          |
| Installing Add-on Cards .....                   | 19          |
| Connecting Optional Devices .....               | 21          |
| <i>Connecting I/O Devices</i> .....             | 25          |
| External Connector Color Coding .....           | 26          |
| <b>CHAPTER 3</b>                                | <b>27</b>   |
| <b>Using BIOS</b>                               | <b>27</b>   |
| <i>About the Setup Utility</i> .....            | 27          |
| The Standard Configuration .....                | 27          |
| Entering the Setup Utility .....                | 28          |
| Updating the BIOS .....                         | 28          |
| <i>Using BIOS</i> .....                         | 29          |
| Standard CMOS Feature .....                     | 30          |
| Advanced BIOS Features .....                    | 32          |

|                                   |    |
|-----------------------------------|----|
| Advanced Chipset Features .....   | 34 |
| Integrated Peripherals .....      | 39 |
| Power Management Setup .....      | 43 |
| PNP/PCI Configurations.....       | 47 |
| PC Health Status.....             | 48 |
| Frequency/Voltage Control.....    | 49 |
| Load Fail-Safe Defaults.....      | 50 |
| Load Optimized Defaults.....      | 50 |
| Set Supervisor/User Password..... | 50 |
| Save & Exit Setup .....           | 51 |
| Exit Without Saving.....          | 51 |

**CHAPTER 4** **52**

|  |           |
|--|-----------|
| <b>Using the Mainboard Software</b> .....                | <b>52</b> |
| <i>About the Software CD-ROM</i> .....                   | 52        |
| <i>Auto-installing under Windows 98/ME/2000/XP</i> ..... | 52        |
| Running Setup .....                                      | 53        |
| <i>Manual Installation</i> .....                         | 55        |
| <i>Utility Software Reference</i> .....                  | 55        |

## *Chapter 1*

# Introducing the Mainboard

---

### Introduction

Thank you for choosing the L7VTA mainboard. The L7VTA is designed to fit the advanced AMD processors in the 462-pin package. Based on the ATX form factor featuring the VIA KT400 Northbridge and VT8235 Southbridge chipsets. This mainboard provides the standard 100/133/166MHz front side bus with extra capability.

The Apollo KT400 chipset consists of the KT400 Northbridge and VT8235 Southbridge. The KT400 Northbridge provides superior performance between the CPU, DRAM, AGP bus, and 8X V-Link bus with pipelined, burst, and concurrent operation. It supports eight banks of DDR Synchronous DRAMs up to 4 GB for registered modules and full AGP 3.0 capability bus utilization including 2x, 4x, and 8x mode transfers, SideBand Addressing, Flush/Fence commands and pipelined grants.

The VT8235 Southbridge supports standard intelligent peripheral controllers such as USB v2.0/1.1 and Universal HCI v2.0/1.1 compliant, real time clock with 256 byte extended CMOS, integrated bus-mastering dual full-duplex direct-sound AC97 link compatible sound system and full System Management Bus (SMBus) interface.

The L7VTA is equipped with advanced full set of I/O ports, such as dual channel IDE interfaces, a floppy controller, two high-speed serial port, an EPP/ECP capable bi-directional parallel port connector, four USB (Universal Serial Bus) connector, a PS/2 keyboard, mouse and 1394a connectors. One AGP slot, five PCI local bus slots and one communication and networking riser (CNR) slot provide expandability for add-on peripheral cards.

---

### Checklist

Compare the mainboard's package contents with the following checklist:

#### Standard Items

- One mainboard
- One diskette drive ribbon cable
- One IDE drive ribbon cable
- One auto-install software support CD
- One I/O shield
- This user's manual

## Features

|                  |   |
|------------------|---|
| <b>Processor</b> | <p>The mainboard uses an AMD 462-pin Socket A that has the following features:</p> <ul style="list-style-type: none"> <li>• Supports 100/133/166 MHz frontside bus (FSB)</li> <li>• Accommodates AMD Duron, Athlon, and Athlon XP processors</li> </ul> <hr/> <p><b>Note:</b> It is recommended that you use AMD Athlon XP or higher level CPU to make sure that the “Thermal Diode” function will work properly.</p>   |
| <b>Chipset</b>   | <p>The chipset on L7VTA includes the KT400 Northbridge and VT8235 Southbridge which are based on an innovative and scalable architecture with proven reliability and performance. A few of the chipset’s advanced features are:</p> <ul style="list-style-type: none"> <li>• Support independent address, data, and snoop interfaces</li> <li>• 200/166/133/100 MHz DDR (Double Data Rate) transfer on Athlon CPU address and data buses</li> <li>• Support 533 MHz 8x, 266 MHz 4x, and 133 MHz 2x transfer modes for Ad and SBA signaling</li> <li>• AGP v3.0 compliant with 8x transfer mode</li> <li>• Supports 66 MHz V-Link Host interface with peak bandwidth of 533 MB/sec</li> <li>• DRAM interface synchronous with host CPU (166/133/100 MHz) for most flexible configuration</li> <li>• Integrated Fast Ethernet Controller with 1/10/100 Mbit capability</li> <li>• Dual channel UltraDMA-33/66/100/133 master mode EIDE controller</li> <li>• Transfer rate up to 133MB/sec to cover PIO mode 4, multi-word DMA mode 2 drivers, and UltraDMA-33 interface</li> <li>• USB v2.0 and Enhanced Host Controller Interface (EHCI) v1.0 compatible</li> <li>• Supports both ACPI (Advanced Configuration and Power Interface) and legacy (APM) power management</li> </ul> <p>Additional features include support for six USB ports, an AC 97 link for audio and modem, hardware monitoring, and ACPI/OnNow power management.</p> |
| <b>Memory</b>    | <ul style="list-style-type: none"> <li>• Supports DDR up to 200/266/333/400 (enhanced) MHz DDR SDRAM memory module</li> <li>• Accommodates three unbuffered 2.5V 184-pin slots</li> <li>• Each slot supports up to 1 GB with a total maximum capacity of 3 GB</li> </ul>  |
| <b>AGP</b>       | <p>The L7VTA includes an 8xAGP slot that provides eight times the bandwidth of the original AGP specification. The AGP 3.0 (8xAGP) offers a significant increase in performance along with feature enhancements to AGP2.0. This interface represents the natural evolution from the existing AGP to meet the ever-increasing demands placed on the graphic interfaces within the workstation and desktop environments.</p>  |

|                                 |  |
|---------------------------------|--|
| <b>AC' 97 Audio Codec</b>       | The AC' 97 Audio codec is compliant with the AC' 97 2.2 specification, and supports 18-bit ADC (Analog Digital Converter) and DAC (Digital Analog Converter) resolution as well as 18-bit stereo full-duplex codec with independent and variable sampling rates. Further features include support for four analog line-level stereo inputs.  |
| <b>Expansion Options</b>        | L7VTA has five 32-bit PCI slots, an AGP slot (supports 1.5V 4x AGP card only) and CNR (Communications and Networking Riser) slot.<br><br>The L7VTA supports Ultra DMA bus mastering with transfer rates of 33/66/100/133 MB/sec.   |
| <b>Onboard LAN (optional)</b>   | The Realtek RTL8100B LAN chip is incorporated in the chipset providing the mainboard with 10/100Mbps fast Ethernet controller and integrated Ethernet PCI LAN capabilities.<br><br>The VT6103 is a Physical Layer device for Ethernet 10BASE-T and 100BASE-TX using category 5 Unshielded, Type 1 Shielded, and Fiber Optic cables. <ul style="list-style-type: none"> <li>• Dual Speed – 100/10 Mbps</li> <li>• Half And Full Duplex</li> <li>• Meet All Applicable IEEE 802.3, 10Base-T and 100Base-Tx Standards</li> <li>• Adaptive Equalizer</li> </ul>          |
| <b>1394a (optional)</b>         | <ul style="list-style-type: none"> <li>• VT6306 PCI 1394a integrated host controller</li> <li>• Compliant with 1394 open HCI specifications v1.0 and v1.1</li> <li>• Supports provisions of IEEE 1394-1995 standard for high performance serial bus and the P1394a supplement 4.0</li> <li>• 32 bit CRC generator and checker for receive and transmit data</li> <li>• Compliant with PCI specification v2.2</li> <li>• High-performance bus mastering support</li> <li>• Provides three 1394a fully compliant cable ports at 100/200/400 Mbit per second</li> </ul> |
| <b>Promise 20265 (optional)</b> | <ul style="list-style-type: none"> <li>• Supports Ultra ATA100 drives and backward compatible with Ultra ATA66/33 &amp; EIDE drives (identical drives recommended)</li> <li>• Supports IDE RAID 1 (mirroring) or 0 (striping)</li> <li>• Supports UDMA 5/4/3/2/1/0, DMA 2/1/0, PIO 4/3/2/1/0 modes</li> <li>• Two independent IDE channels support up to four UDMA/100/66/33 or EIDE drives</li> </ul>   |
| <b>Integrated I/O</b>           | The mainboard has a full set of I/O ports and connectors: <ul style="list-style-type: none"> <li>• Two PS/2 ports for mouse and keyboard</li> <li>• Two serial port</li> <li>• One parallel port</li> <li>• Four USB ports</li> <li>• One 1394a port (optional)</li> <li>• Audio jacks for microphone, line-in and line-out</li> </ul>   |

|                      |   |
|----------------------|---|
| <b>BIOS Firmware</b> | <p>This mainboard uses Award BIOS that enables users to configure many system features including the following:</p> <ul style="list-style-type: none"><li>• Power management</li><li>• Wake-up alarms</li><li>• CPU parameters</li><li>• CPU and memory timing</li></ul> <p>The firmware can also be used to set parameters for different processor clock speeds.</p> |
|----------------------|---|

---

## Choosing a Computer Case

There are many types of computer cases on the market. The mainboard complies with the specifications for the ATX system case. Some features on the mainboard are implemented by cabling connectors on the mainboard to indicators and switches on the system case. Ensure that your case supports all the features required. The mainboard can support one or two floppy diskette drives and four enhanced IDE drives. Ensure that your case has sufficient power and space for all the drives that you intend to install.

Most cases have a choice of I/O templates in the rear panel. Make sure that the I/O template in the case matches the I/O ports installed on the rear edge of the mainboard.

This mainboard has an ATX form factor of 305 mm x 244 mm. Choose a case that accommodates this form factor.



## Mainboard Components

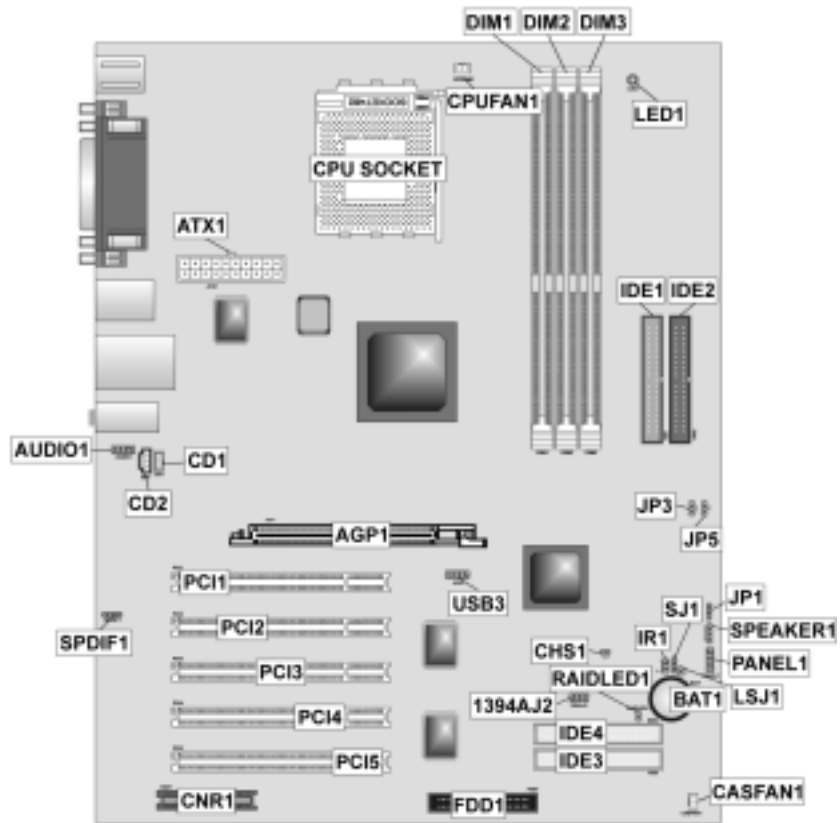

## Table of Mainboard Components

| Label             | Component  |
|-------------------|--|
| 1394J2            | IEEE 1394A header  |
| AGP1              | Accelerated Graphics Port (supports 1.5V 4x AGP card only) |
| ATX1              | Standard 20-pin ATX power connector                        |
| AUDIO1            | Front audio connector                                      |
| BAT1              | Three volt realtime clock battery                          |
| CASFAN1           | Case fan connector   |
| CD1               | Primary CD-in connector                                    |
| CD2               | Secondary CD-in connector                                  |
| CHS1              | Chassis Intrusion Detect                                   |
| CNR1              | Communications Networking Riser slot                       |
| CPU SOCKET        | Socket A for AMD Athlon/Duron CPUs                         |
| CPUFAN1           | Cooling fan for CPU  |
| DIM1 ~ DIM3       | Three 184-pin DDR SDRAM                                    |
| FDD1              | Floppy disk drive connector                                |
| IDE 1             | Primary IDE channel  |
| IDE 2             | Secondary IDE channel                                      |
| IDE 3             | Third IDE channel for ATA 66/100                           |
| IDE 4             | Fourth IDE channel for ATA 66/100                          |
| IR1               | Infrared port  |
| JP1               | Clear CMOS jumper  |
| JP3               | CPU Frequency jumper                                       |
| JP5               | CPU Frequency jumper                                       |
| LED1 <sup>1</sup> | Memory module LED  |
| LSJ1              | Single color LED header <i>(for OEM customers only)</i>    |
| PANEL1            | Connector for case front panel switches and LED indicators |
| PCI1 ~ PCI5       | Five 32-bit add-on card slots                              |
| RAIDLED1          | IDE3/IDE4 array controller active LED                      |
| SJ1               | Single color LED header                                    |
| SPEAKER1          | Speaker connector  |
| SPDIF1            | SPDIF out header   |
| USB3              | Connector for front panel USB ports                        |

This concludes Chapter 1. The next chapter explains how to install the mainboard.

---

<sup>1</sup> The red indicator LED1 turns on if your system is still powered, at which time memory modules cannot be installed or uninstalled.

## Chapter 2

# Installing the Mainboard

---

### Safety Precautions

Follow these safety precautions when installing the mainboard:

- Wear a grounding strap attached to a grounded device to avoid damage from static electricity.
- Discharge static electricity by touching the metal case of a safely grounded object before working on the mainboard.
- Leave components in the static-proof bags they came in.
- Hold all circuit boards by the edges. Do not bend circuit boards.

---

### Quick Guide

This Quick Guide suggests the steps you can take to assemble your system with the mainboards.

The following table provides a reference for installing specific components:

|  |               |
|--|---------------|
| <b>Locating Mainboard Components</b>       | Go to page 5  |
| <b>Installing the Mainboard in a Case</b>  | Go to page 8  |
| <b>Setting Jumpers</b>                     | Go to page 8  |
| <b>Installing Case Components</b>          | Go to page 10 |
| <b>Installing the CPU</b>                  | Go to page 13 |
| <b>Installing Memory</b>                   | Go to page 16 |
| <b>Installing an HDD and CD-ROM Drive</b>  | Go to page 17 |
| <b>Installing an FDD</b>                   | Go to page 19 |
| <b>Installing Add-on Cards</b>             | Go to page 19 |
| <b>Connecting Options</b>                  | Go to page 21 |
| <b>Connecting Peripheral (I/O) Devices</b> | Go to page 25 |

---

## Installing the Mainboard in a Case

Refer to the following illustration and instructions for installing the mainboard in a case:

This illustration shows an example of a mainboard being installed in a tower-type case:

**Note:** Do not overtighten the screws as this can stress the mainboard.

Most system cases have mounting brackets installed in the case, which correspond to the holes in the mainboard. Place the mainboard over the mounting brackets and secure the mainboard onto the mounting brackets with screws.

2. Secure the mainboard with screws where appropriate.

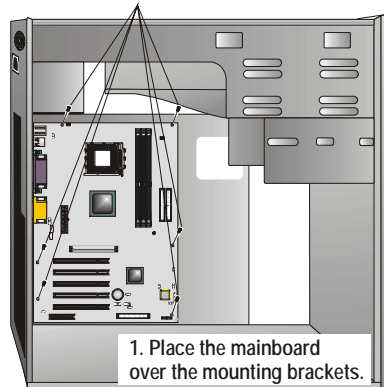

Ensure that your case has an I/O template that supports the I/O ports and expansion slots on your mainboard.

---

## Checking Jumper Settings

This section explains how to set jumpers for correct configuration of the mainboard.

### Setting Jumpers

Use the mainboard jumpers to set system configuration options. Jumpers with more than one pin are numbered. When setting the jumpers, ensure that the jumper caps are placed on the correct pins.

The illustrations below show a 2-pin jumper. When the jumper cap is placed on both pins, the jumper is SHORT. If you remove the jumper cap, or place the jumper cap on just one pin, the jumper is OPEN.

This illustration shows a 3-pin jumper. Pins 1 and 2 are SHORT.

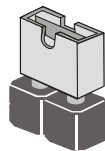

Short

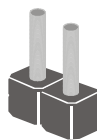

Open

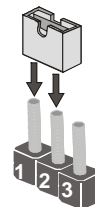

## Checking Jumper Settings

The following illustration shows the location of the mainboard jumpers. Pin 1 is labeled.

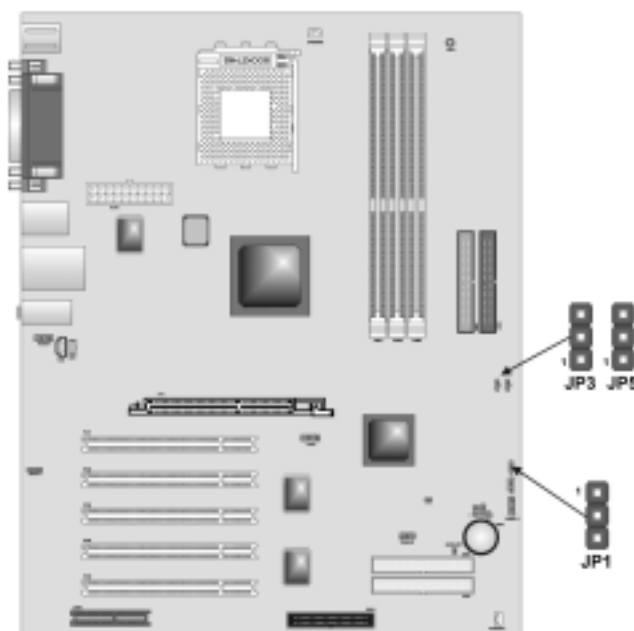

## Jumper Settings

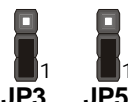
| Jumper    | Type  | Description                 | Setting (default)   |
|-----------|-------|-----------------------------|---|
| JP1       | 3-pin | Clear CMOS                  | 1-2: Normal<br>2-3: <i>Clear CMOS</i><br><br>JP1         |
| JP3 & JP5 | 3-pin | CPU Frequency select jumper | See table on following page for settings.<br><br>JP3 JP5 |

**JP1** – Use this jumper to clear the contents of the CMOS memory. You may need to clear the CMOS memory if the settings in the Setup Utility are incorrect and prevent your mainboard from operating. To clear the CMOS memory, disconnect all the power cables from the mainboard and then move the jumper cap into the CLEAR setting for a few seconds.

**JP3 & JP5** – This jumper enables you to set the CPU frequency.

| JP3       | JP5       | CPU Frequency  |
|-----------|-----------|----------------|
| Short 1-2 | Short 1-2 | 100MHz         |
| Short 2-3 | Short 1-2 | 133MHz         |
| Short 1-2 | Short 2-3 | Not Applicable |
| Short 2-3 | Short 2-3 | 166MHz         |

## Connecting Case Components

After you have installed the mainboard into a case, you can begin connecting the mainboard components. Refer to the following:

|  |  |
|--|--|
| <ol style="list-style-type: none"> <li>1. Connect the CPU cooling fan cable to <b>CPUFAN1</b>.</li> <li>2. Connect the case cooling fan connector to <b>CASFAN1</b>.</li> <li>3. Connect the case speaker cable to <b>SPEAKER1</b>.</li> <li>4. Connect the case LED cable to <b>SJ1/LSJ1</b>.</li> <li>5. Connect the case switches and indicator to <b>PANEL1</b>.</li> <li>6. Connect the standard power supply connector to <b>ATX1</b>.</li> <li>7. If your case has a case open alarm cable, connect it to <b>CHS1</b>.</li> </ol> |  |
|--|--|

### ATX1: ATX 20-pin Power Connector

| Pin | Signal Name | Pin | Signal Name |
|-----|-------------|-----|-------------|
| 1   | +3.3V       | 11  | +3.3V       |
| 2   | +3.3V       | 12  | -12V        |
| 3   | Ground      | 13  | Ground      |
| 4   | +5V         | 14  | PS ON#      |
| 5   | Ground      | 15  | Ground      |
| 6   | +5V         | 16  | Ground      |
| 7   | Ground      | 17  | Ground      |
| 8   | PWRGD       | 18  | +5V         |
| 9   | +5VSB       | 19  | +5V         |
| 10  | +12V        | 20  | +5V         |

### CPUFAN1/CASFAN1: FAN Power Connectors

| Pin | Signal Name | Function      |
|-----|-------------|---------------|
| 1   | GND         | System Ground |
| 2   | +12V        | Power +12V    |
| 3   | Sense       | Sensor        |

### SPEAKER1: Internal speaker

| Pin | Signal Name |
|-----|-------------|
| 1   | Signal      |
| 2   | NC          |
| 3   | Ground      |
| 4   | VCC         |

### CHS1: Chassis Intrusion Detect

This connector allows the user to detect unauthorized intrusion to the case. It will alert the user with a warning message when the case is turned on.

### SJI: Single-color LED header

| Pin | Signal Name |
|-----|-------------|
| 1   | ACPI LED    |
| 2   | ACPI LED    |
| 3   | 5VSB        |

#### ACPI LED function:

| SJ1   | S0    | S1       | S3       | S4/S5 |
|---|-------|----------|----------|-------|
|  | Light | Blinking | Blinking | Dark  |

### LSJI: Single color LED header *(for OEM customers only)*

| Pin | Signal Name |
|-----|-------------|
| 1   | 5VSB        |
| 2   | SUSLED-Y    |

#### ACPI LED function:

| LSJ1  | S0   | S1   | S3    | S4/S5 |
|---|------|------|-------|-------|
|  | Dark | Dark | Light | Dark  |

## Front Panel Connector

The front panel connector (PANEL1) provides a standard set of switch and LED connectors commonly found on ATX or micro-ATX cases. Refer to the table below for information:

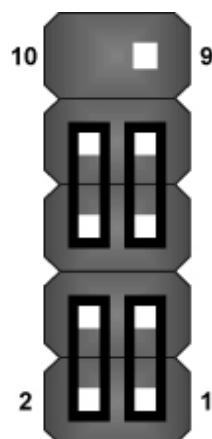

| Pin | Signal Name | Function   |
|-----|-------------|--|
| 1   | HD_LED_P    | Hard disk LED pull up (330 ohm) to 5VSB                |
| 2   | MSG+        | MSG LED pull up (330 ohm) to 5VSB                      |
| 3   | HD_LED_N    | Hard disk active LED                                   |
| 4   | MSG-        | MSG LED pull up (330 ohm) to 5VSB                      |
| 5   | GND         | Ground   |
| 6   | PWR_SW_P    | Power Switch high reference pull up (4700 ohm) to 5VSB |
| 7   | RST_SW_P    | Reset Switch high reference pull up (8200 ohm) to 5VSB |
| 8   | GND         | Ground   |
| 9   | RSVD        | Reserved (do not use)                                  |
| 10  | NC          | No pin   |

PANEL1

### Hard Drive Activity LED

Connecting pins 1 and 3 to a front panel mounted LED provides visual indication that data is being read from or written to the hard drive. For the LED to function properly, an IDE drive should be connected to the onboard IDE interface. The LED will also show activity for devices connected to the SCSI (hard drive activity LED) connector.

### Power / Sleep / Message Waiting LED

Connecting pins 2 and 4 to a single- or dual-color, front panel mounted LED provides power on/off, sleep, and message waiting indication.

### Reset Switch

Supporting the reset function requires connecting pins 5 and 7 to a momentary-contact switch that is normally open. When the switch is closed, the board resets and runs POST.

### Power Switch

Supporting the power on/off function requires connecting pins 6 and 8 to a momentary-contact switch that is normally open. The switch should maintain contact for at least 50 ms to signal the power supply to switch on or off. The time requirement is due to internal debounce circuitry. After receiving a power on/off signal, at least two seconds elapses before the power supply recognizes another on/off signal.



---

## Installing Hardware

### Installing the Processor

**Caution:** When installing a CPU heatsink and cooling fan make sure that you DO NOT scratch the mainboard or any of the surface-mount resistors with the clip of the cooling fan. If the clip of the cooling fan scrapes across the mainboard, you may cause serious damage to the mainboard or its components.

On most mainboards, there are small surface-mount resistors near the processor socket, which may be damaged if the cooling fan is carelessly installed.

Avoid using cooling fans with sharp edges on the fan casing and the clips. Also, install the cooling fan in a well-lit work area so that you can clearly see the mainboard and processor socket.

### Before installing the Processor

This mainboard automatically determines the CPU clock frequency and system bus frequency for the processor. You may be able to change these settings by making changes to jumpers on the mainboard, or changing the settings in the system Setup Utility. We strongly recommend that you do not overclock processors or other components to run faster than their rated speed.

**Warning:** Overclocking components can adversely affect the reliability of the system and introduce errors into your system. Overclocking can permanently damage the mainboard by generating excess heat in components that are run beyond the rated limits.

This mainboard has a Socket 462 processor socket. When choosing a processor, consider the performance requirements of the system. Performance is based on the processor design, the clock speed and system bus frequency of the processor, and the quantity of internal cache memory and external cache memory.

## CPU Installation Procedure

The following illustration shows CPU installation components:

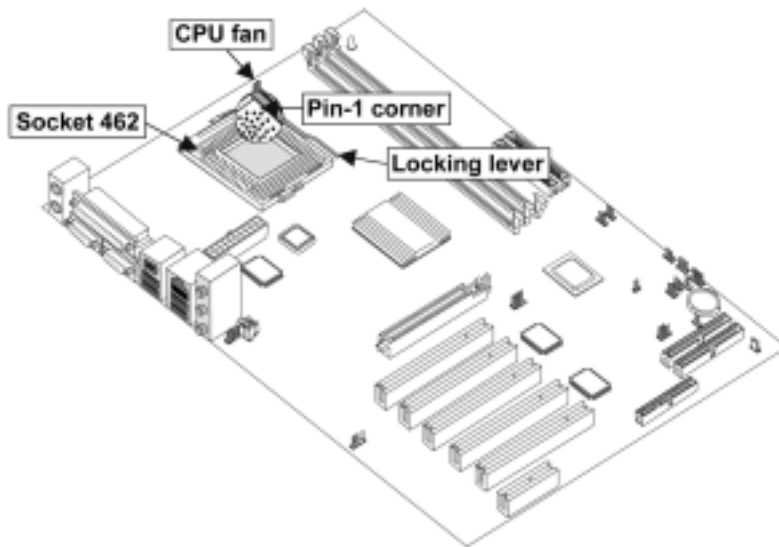

**Note:** The pin-1 corner is marked with an arrow ▼

Follow these instructions to install the CPU:

|    |   |
|----|---|
| 1. | Pull the CPU socket locking lever away from the socket to unhook it and raise the locking lever to the upright position.  |
| 2. | Match the corner on the CPU marked with an arrow with pin A-1 on the CPU socket (the corner with the pinhole noticeably missing). Insert the processor into the socket. Do not use force. |
| 3. | Swing the locking lever down and hook it under the latch on the edge of the socket.   |
| 4. | Apply thermal grease to the top of the CPU.   |
| 5. | Lower the CPU cooling fan/heatsink assembly onto the CPU  |
| 6. | Secure the two retention clips on either side of the fan/heatsink unit onto the Socket 462 base.  |

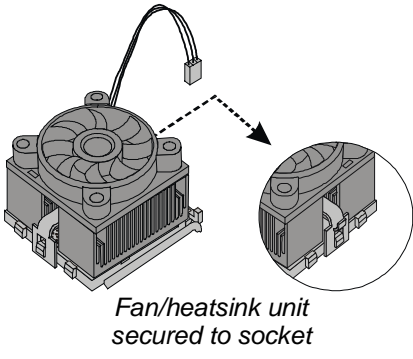

The diagram shows a fan/heatsink unit being lowered onto the CPU. A dashed arrow points from the unit to a circular inset showing the unit's retention clips being secured to the socket base. Below the diagram, the text reads: *Fan/heatsink unit secured to socket*

7. Connect the CPU Cooling Fan power cable connector to the CPUFAN connector.

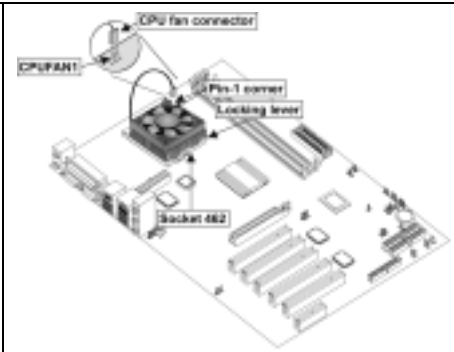

**Note:** CPU fan and heatsink installation procedures may vary with the type of CPU fan/heatsink supplied. The form and size of fan/heatsink may also vary.

## Installing Memory Modules

This mainboard accommodates three 184-pin 2.5V unbuffered Double Data Rate (DDR) SDRAM memory modules. When you installed DDR266 memory modules, the memory bus can run up to 133 MHz. If you have DDR200, this can only run up to 100 MHz.

---

**Note:** SDRAM provides 800 MBps or 1 GBps data transfer depending on whether the bus is 100MHz or 133MHz. Double Data Rate SDRAM (DDR SDRAM) doubles the rate to 1.6 GBps and 2.1 GBps. DDR SDRAM uses additional power and ground lines and requires 184-pin DIMM modules rather than the 168-pin DIMMs used by SDRAM.

---

The mainboard accommodates three memory modules. You must install at least one module in any of the three slots. Each module can be installed with 32 MB to 1 GB of memory; total memory capacity is 3GB.



Do not remove any memory module from its antistatic packaging until you are ready to install it on the mainboard. Handle the modules only by their edges. Do not touch the components or metal parts. Always wear a grounding strap when you handle the modules.

## Installation Procedure

Refer to the following to install the memory modules.

1. This mainboard supports unbuffered DDR SDRAM only. Do not attempt to insert any other type of DDR SDRAM into the slots.



2. Push the latches on each side of the DIMM slot down.

3. Align the memory module with the slot. The DIMM slots are keyed with notches and the DIMMs are keyed with cutouts so that they can only be installed correctly.

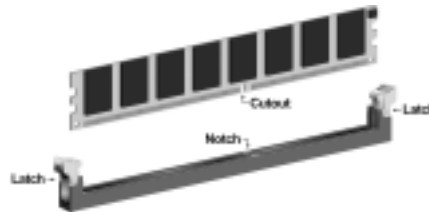

4. Check that the cutouts on the DIMM module edge connector match the notches in the DIMM slot.

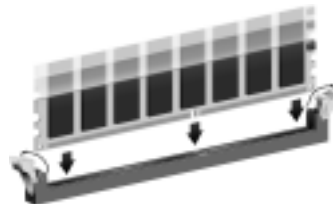

5. Install the DIMM module into the slot and press it firmly down until it seats correctly. The slot latches are levered upwards and latch on to the edges of the DIMM.

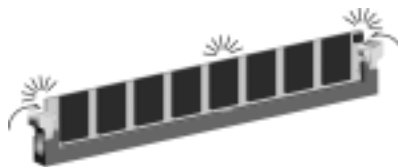

6. Install any remaining DIMM modules.

**DDR SDRAM memory module table:**

|         |         |
|---------|---------|
| DDR 266 | 3 DIMMS |
| DDR 333 | 3 DIMMS |
| DDR 400 | 2 DIMMS |

---

**Note:** We do not guarantee that all DDR 400 memory modules will work properly with your mainboard.

---

## Installing a Hard Disk Drive/CD-ROM

This section describes how to install IDE devices such as a hard disk drive and a CD-ROM drive.

### About IDE1 and IDE2 Devices

Your mainboard has a primary and secondary IDE channel interface (IDE1 and IDE2). An IDE ribbon cable supporting two IDE devices is bundled with the mainboard.

If you want to install more than two IDE devices, get a second IDE cable and you can add two more devices to the secondary IDE channel.

IDE devices have jumpers or switches that are used to set the IDE device as MASTER or SLAVE. Refer to the IDE device user's manual. When installing two IDE devices on one cable, ensure that one device is set to MASTER and the other device is set to SLAVE. The documentation of your IDE device explains how to do this.

### About IDE3 and IDE4 Devices

The third and fourth IDE channels are provided for IDE RAID function. These channels are booted by hard disk drive only. Other device such as CD-ROM and ZIP does not support this function. For installing devices on IDE3 and IDE4, follow the same procedures for IDE1 and IDE2 "Installing a Hard Disk Drive".

### About UltraDMA

This mainboard supports UltraDMA 66/100/133. UDMA is a technology that accelerates the performance of devices in the IDE channel. To maximize performance, install IDE devices that support UDMA and use 80-pin IDE cables that support UDMA 66/100/133.

## Installing a Hard Disk Drive

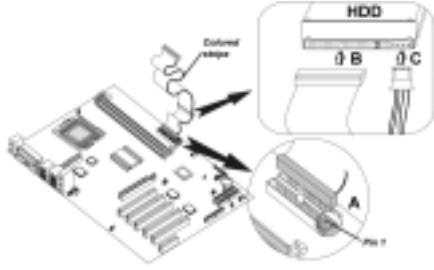
|   |  |
|---|--|
| 1. Install the hard disk drive into the drive cage in your system case.   |  |
| <p>2. Plug the IDE cable into IDE1 (A):</p> <p><b>Note:</b> Ribbon cable connectors are usually keyed so that they can only be installed correctly on the device connector. If the connector is not keyed, make sure that you match the pin-1 side of the cable connector with the pin-1 side of the device connector. Each connector has the pin-1 side clearly marked. The pin-1 side of each ribbon cable is always marked with a colored stripe on the cable.</p> |  |
| 3. Plug an IDE cable connector into the hard disk drive IDE connector (B). It doesn't matter which connector on the cable you use.  |  |
| 4. Plug a power cable from the case power supply into the power connector on the hard disk drive (C).   |  |

When you first start up your system, the BIOS should automatically detect your hard disk drive. If it doesn't, enter the Setup Utility and use the IDE Hard Disk Auto Detect feature to configure the hard disk drive that you have installed. See IDE HDD Auto-Detection on page 31 for more information.

## Installing a CD-ROM/DVD Drive

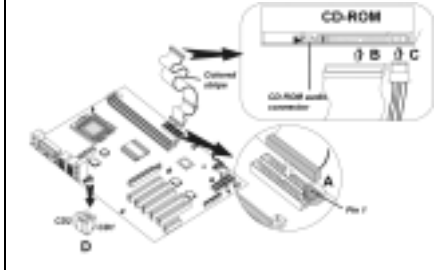
|   |  |
|---|--|
| 1. Install the CD-ROM/DVD drive into the drive cage in your system case.  |  |
| <p>2. Plug the IDE cable into IDE1 (A). If you have already installed an HDD, use the other connector on the IDE cable.</p> <p><b>Note:</b> Ribbon cable connectors are usually keyed so that they can only be installed correctly on the device connector. If the connector is not keyed, make sure that you match the pin-1 side of the cable connector with the pin-1 side of the device connector. Each connector has the pin-1 side clearly marked. The pin-1 side of each ribbon cable is always marked with a colored stripe on the cable.</p> |  |
| 3. Plug an IDE cable connector into the CD-ROM/DVD drive IDE connector (B). It doesn't matter which connector on the cable you use.   |  |
| 4. Plug a power cable from the case power supply into the power connector on the CD-ROM/DVD drive (C).  |  |
| 5. Use the audio cable provided with the CD-ROM/DVD drive to connect to the mainboard CD-in connector CDIN1 or CDIN2 (D).   |  |

When you first start up your system, the BIOS should automatically detect your CD-ROM/DVD drive. If it doesn't, enter the Setup Utility and configure the CD-ROM/DVD drive that you have installed. See IDE Primary/Secondary Master/Slave on page 31 for more information.

## Installing a Floppy Diskette Drive

The mainboard has a floppy diskette drive (FDD) interface and ships with a diskette drive ribbon cable that supports one or two floppy diskette drives. You can install a 5.25-inch drive and a 3.5-inch drive with various capacities. The floppy diskette drive cable has one type of connector for a 5.25-inch drive and another type of connector for a 3.5-inch drive.

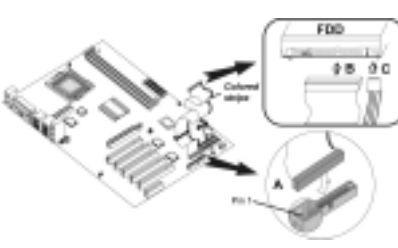
|   |  |
|---|--|
| <p>1. Install the FDD into the drive cage in your system case.</p> <p>2. Plug the FDD cable into FLOPPY1 (A):</p> <p><b>Note:</b> Ribbon cable connectors are usually keyed so that they can only be installed correctly on the device connector. If the connector is not keyed, make sure that you match the pin-1 side of the cable connector with the pin-1 side of the device connector. Each connector has the pin-1 side clearly marked. The pin-1 side of each ribbon cable is always marked with a colored stripe on the cable.</p> |  |
| <p>3. Plug the correct connector on the FDD cable for the 5.25-inch or 3.5-inch drive into the FDD connector (B).</p>   |  |
| <p>4. Plug a power cable from the case power supply into the power connector on the FDD (C).</p>  |  |

When you first start up your system, go immediately to the Setup Utility to configure the floppy diskette drives that you have installed. See Standard CMOS Feature on page 30 for more information.

## Installing Add-on Cards

This mainboard has five 32-bit PCI (Peripheral Components Interconnect) expansion slots, one 8xAGP slot, and one Communications and Networking Riser (CNR) slot.

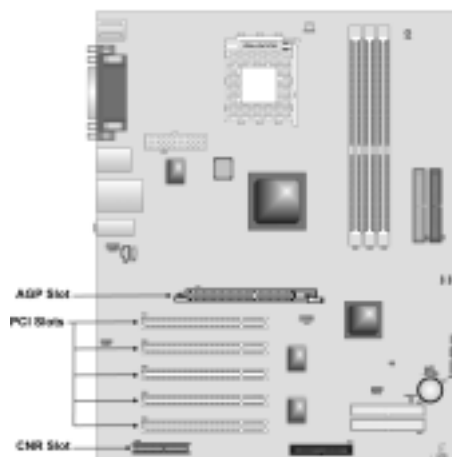

- PCI Slots** PCI slots are used to install expansion cards that have the 32-bit PCI interface.
- 8xAGP Slot** The 8xAGP slot is used to install a graphics adapter that supports the 8xAGP specification and has a 8xAGP edge connector. The 8x AGP slot supports 1.5V 4x AGP and 2x AGP cards only.

**Note:** The above layout is for reference only. The AGP slot may be different from your mainboard. Please refer to actual shipment.

- CNR Slot** This slot is used to insert CNR cards with Modem and Audio functionality.

**Note:** Before installing an add-on card, check the documentation for the card carefully. If the card is not Plug and Play, you may have to manually configure the card before installation.

Follow these instructions to install an add-on card:

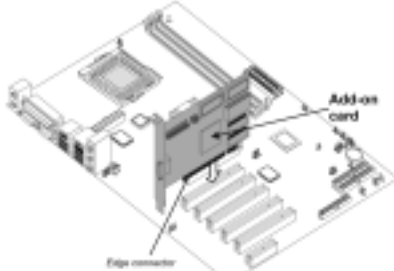
- |   |   |
|---|---|
| 1. Remove a blanking plate from the system case corresponding to the slot you are going to use.   |   |
| 2. Install the edge connector of the add-on card into the expansion slot. Ensure that the edge connector is correctly seated in the slot. |  |
| 3. Secure the metal bracket of the card to the system case with a screw.  |   |

**Note:** For some add-on cards, for example graphics adapters and network adapters, you have to install drivers and software before you can begin using the add-on card.



## Connecting Optional Devices

Refer to the following for information on connecting the mainboard's optional devices:

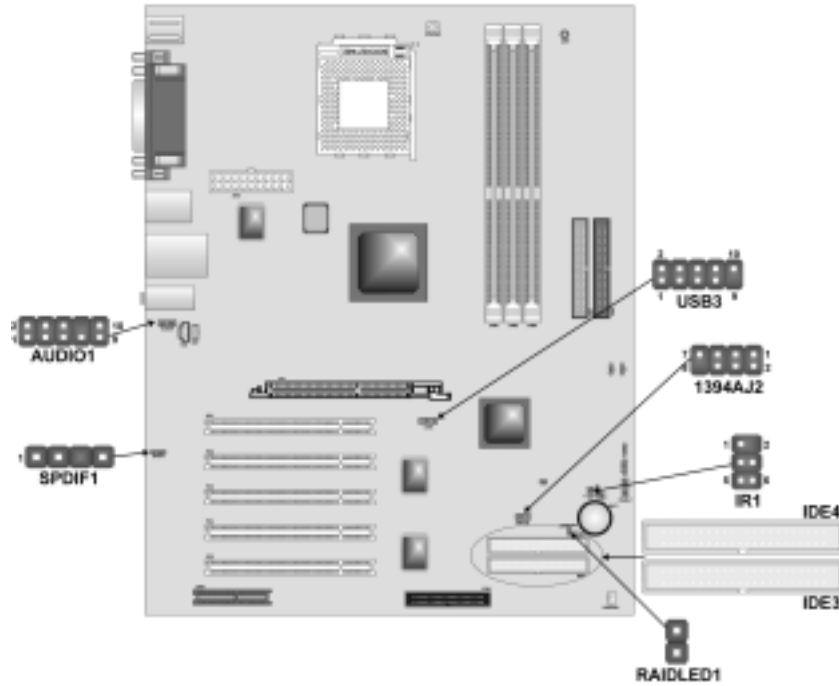

### AUDIO1: Front Panel Audio header

This header allows the user to install auxiliary front-oriented microphone and line-out ports for easier access.

| Pin | Signal Name  | Function  |
|-----|--------------|---|
| 1   | AUD_MIC      | Front Panel Microphone input signal                     |
| 2   | AUD_GND      | Ground used by Analog Audio Circuits                    |
| 3   | AUD_MIC_BIAS | Microphone Power  |
| 4   | AUD_VCC      | Filtered +5 V used by Analog Audio Circuits             |
| 5   | AUD_FPOUT_R  | Right Channel Audio signal to Front Panel               |
| 6   | AUD_RET_R    | Right Channel Audio signal to Return from Front Panel   |
| 7   | HP_ON        | Reserved for future use to control Head-phone Amplifier |
| 8   | KEY          | No Pin  |
| 9   | AUD_FPOUT_L  | Left Channel Audio signal to Front Panel                |
| 10  | AUD_RET_L    | Left Channel Audio signal Return from Front Panel       |

## USB3: Front Panel USB connector

The mainboard has four USB ports installed on the rear edge I/O port array. Additionally, some computer cases have USB ports at the front of the case. If you have this kind of case, use auxiliary USB connector USB3 to connect the front-mounted ports to the mainboard.

| Pin | Signal Name     | Function                   |
|-----|-----------------|----------------------------|
| 1   | VREG_FP_USBPWR0 | Front Panel USB Power      |
| 2   | VREG_FP_USBPWR0 | Front Panel USB Power      |
| 3   | USB_FP_P0-      | USB Port 0 Negative Signal |
| 4   | USB_FP_P1-      | USB Port 1 Negative Signal |
| 5   | USB_FP_P0+      | USB Port 0 Positive Signal |
| 6   | USB_FP_P1+      | USB Port 1 Positive Signal |
| 7   | GND             | Ground                     |
| 8   | GND             | Ground                     |
| 9   | KEY             | No pin                     |
| 10  | USB_FP_OC0      | Overcurrent signal         |

**Note:** Please make sure that the USB cable has the same pin assignment as indicated above. A different pin assignment may cause damage or system hang-up.

## IR1: Serial infrared port

The mainboard supports an Infrared (IR1) data port. Infrared ports allow the wireless exchange of information between your computer and similarly equipped devices such as printers, laptops, Personal Digital Assistants (PDAs), and other computers.

| Pin | Signal Name  | Function           |
|-----|--------------|--------------------|
| 1   | Not assigned | Not assigned       |
| 2   | KEY          | No pin             |
| 3   | +5V          | IR Power           |
| 4   | GND          | Ground             |
| 5   | IRTX         | IrDA serial output |
| 6   | IRRX         | IrDA serial input  |

## SPDIF1: SPDIF out header

You can purchase an optional 24-bit digital audio extension bracket from a third-party vendor. You can use the audio RCA jacks to connect to digital audio devices. If your CD-ROM/DVD drive has digital audio output, you can connect it to the input pins of the SPDIF connector.

| Pin | Signal Name | Function             |
|-----|-------------|----------------------|
| 1   | SPDIF       | SPDIF digital output |
| 2   | +5VA        | 5V analog power      |
| 3   | NC          | Not connected        |
| 4   | GND         | Ground               |

### 1394AJ2: IEEE 1394A header

Use this header to connect to any IEEE 1394A interface.

| Pin | Signal Name | Pin | Signal Name |
|-----|-------------|-----|-------------|
| 1   | Cable-power | 5   | TPA-        |
| 2   | GND         | 6   | TPA+        |
| 3   | TPB-        | 7   | Chassis GND |
| 4   | TPB+        | 8   | NC          |

### RAIDLED: IDE3/IDE4 array controller active LED

This connector is used to show the activity of the IDE3/IDE4 HDD. The IDE LED is located on pins 1-2 of RAIDLED. You can attach the hard drive LED cable to pins 1-2.

| Pin | Signal Name |
|-----|-------------|
| 1   | +5V         |
| 2   | IDE active  |

## IDE3/IDE4: Third/Fourth IDE connector

These connectors are for Promise PDC20265R controller only. Connect one cable to each of the IDE connectors of the mainboard (IDE3 & IDE4 connector). Please note the color orientation of the cable before attaching it to the mainboard. If you wish to use the IDE array controller, please refer to the optional "Promise Raid" user's manual.

Promise PDC20265R supports striping (RAID 0) or mirroring (RAID 1), separately.

With striping, identical drives can read and write data in parallel to increase performance. Mirroring increases read performance through load balancing and elevator sorting while creating a complete backup of your files.

It offers RAID 1 mirroring (for two drives) to protect data. Should a drive that is part of a mirrored array fail, Promise PDC20265R uses the mirrored drive (which contains identical data) to assume all data handling. When a new replacement drive is later installed, Promise PDC20265R rebuilds data to the new drive from the mirrored drive to restore fault tolerance.

### **RAID 0 (Striping)**

*Configures multiple drives so that sectors of data are interleaved within an array. When a disk member fails, it affects the entire array. Performance is better than a single drive since the workload is balanced between array members. This array mode is designed for high performance systems. Identical drives are recommended for performance as well as data storage efficiency. The disk array data capacity is equal to the number of drive members times the smallest member capacity.*

### **RAID 1 (Mirroring)**

*Configures an array of 2 drives to write duplicate data and read in parallel. It performs reads using advanced data handling techniques that distribute the workload in a more efficient manner than using a single drive. When a read request is made, it selects the drive positioned closest to the requested data, and then looks to the idle drive to perform the next read access.*

Promise PDC20265R striped arrays can double the sustained data transfer rate of Ultra ATA/100 drives. Promise PDC20265R fully supports Ultra ATA/100 specification of up to 100 MB/sec per drive, depending on individual drive specifications.

---

**Note:** Please use an 80-wire, 40-pin cable when connecting an Ultra ATA/100 hard drive to the motherboard IDE3 & IDE4 controller.

---

---

## Connecting I/O Devices

The backplane of the mainboard has the following I/O ports:

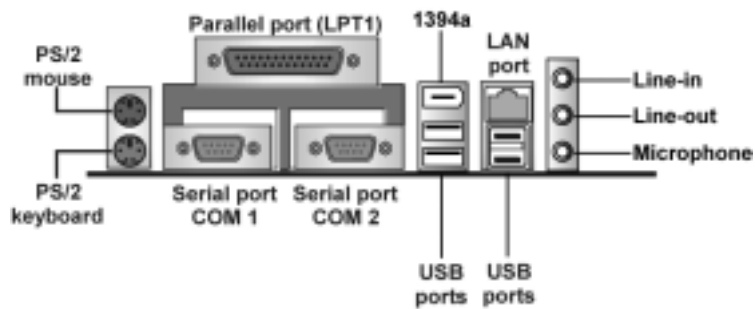

|                              |   |
|------------------------------|---|
| <b>PS/2 Mouse</b>            | Use the upper PS/2 port to connect a PS/2 pointing device.  |
| <b>PS/2 Keyboard</b>         | Use the lower PS/2 port to connect a PS/2 keyboard.   |
| <b>LPT1</b>                  | Use LPT1 to connect printers or other parallel communications devices.  |
| <b>COM1/2</b>                | Use the COM ports to connect serial devices such as mice or fax/modems. COM1 is identified by the system as COM1/3. COM2 is identified by the system as COM2/4.                   |
| <b>1394a Port (optional)</b> | Use the 1394a port to connect any Firewire device.  |
| <b>Audio Ports</b>           | Use the three audio ports to connect audio devices. The first jack is for stereo line-in signal. The second jack is for stereo line-out signal. The third jack is for microphone. |
| <b>LAN Port (optional)</b>   | Connect an RJ-45 jack to the LAN port to connect your computer to the Network.  |
| <b>USB Ports</b>             | Use the USB ports to connect USB devices.   |

## External Connector Color Coding

Many connectors now use standard colors as shown in the table below.

| <b>Connector</b>                | <b>Color</b>      |
|---------------------------------|-------------------|
| Audio line-in                   | Light blue        |
| Audio line-out                  | Lime              |
| Digital monitor/flat panel      | White             |
| IEEE 1394                       | Grey              |
| Microphone                      | Pink              |
| MIDI/game                       | Gold              |
| Parallel                        | Burgundy          |
| PS/2-compatible keyboard        | Purple            |
| PS/2-compatible mouse           | Green             |
| Serial                          | Teal or Turquoise |
| Speaker out/subwoofer           | Orange            |
| Right-to-left speaker           | Brown             |
| USB                             | Black             |
| Video out                       | Yellow            |
| SCSI, network, telephone, modem | None              |

This concludes Chapter 2. The next chapter covers the BIOS.

## Chapter 3

# Using BIOS

---

### About the Setup Utility

The computer uses the latest Award BIOS with support for Windows Plug and Play. The CMOS chip on the mainboard contains the ROM setup instructions for configuring the mainboard BIOS.

The BIOS (Basic Input and Output System) Setup Utility displays the system's configuration status and provides you with options to set system parameters. The parameters are stored in battery-backed-up CMOS RAM that saves this information when the power is turned off. When the system is turned back on, the system is configured with the values you stored in CMOS.

The BIOS Setup Utility enables you to configure:

- Hard drives, diskette drives, and peripherals
- Video display type and display options
- Password protection from unauthorized use
- Power management features

The settings made in the Setup Utility affect how the computer performs. Before using the Setup Utility, ensure that you understand the Setup Utility options.

This chapter provides explanations for Setup Utility options.

### The Standard Configuration

A standard configuration has already been set in the Setup Utility. However, we recommend that you read this chapter in case you need to make any changes in the future.

This Setup Utility should be used:

- when changing the system configuration
- when a configuration error is detected and you are prompted to make changes to the Setup Utility
- when trying to resolve IRQ conflicts
- when making changes to the Power Management configuration
- when changing the password or making other changes to the Security Setup

## Entering the Setup Utility

When you power on the system, BIOS enters the Power-On Self Test (POST) routines. POST is a series of built-in diagnostics performed by the BIOS. After the POST routines are completed, the following message appears:

### Press DEL to enter SETUP

Pressing the delete key  accesses the BIOS Setup Utility:

Phoenix - AwardBIOS CMOS Setup Utility

|                                 |                         |
|---------------------------------|-------------------------|
| ▶ <b>Standard CMOS Features</b> | ▶ Frequency Control     |
| ▶ Advanced BIOS Features        | Load Fail-Safe Defaults |
| ▶ Advanced Chipset Features     | Load Optimized Defaults |
| ▶ Integrated Peripherals        | Set Supervisor Password |
| ▶ Power Management Setup        | Set User Password       |
| ▶ PnP/PCI Configurations        | Save & Exit Setup       |
| ▶ PC Health Status              | Exit Without Saving     |
| Esc : Quit                      |                         |
| F10 : Save & Exit Setup         |                         |
| ↑ ↓ → ← : Select Item           |                         |
| Time, Date, Hard Disk Type ...  |                         |

## BIOS Navigation Keys

The BIOS navigation keys are listed below:

| Key       | Function  |
|-----------|---|
| Esc       | Exits the current menu                              |
| ←↑↓→      | Scrolls through the items on a menu                 |
| +/-/PU/PD | Modifies the selected field's values                |
| F10       | Saves the current configuration and exits setup     |
| F1        | Displays a screen that describes all key functions  |
| F5        | Loads previously saved values to CMOS               |
| F6        | Loads a minimum configuration for troubleshooting.  |
| F7        | Loads an optimum set of values for peak performance |

## Updating the BIOS

You can download and install updated BIOS for this mainboard from the manufacturer's Web site. New BIOS provides support for new peripherals, improvements in performance, or fixes for known bugs. Install new BIOS as follows:

1. If your mainboard has a BIOS protection jumper, change the setting to allow BIOS flashing.



2. If your mainboard has an item called Firmware Write Protect in Advanced BIOS features, disable it. (Firmware Write Protect prevents BIOS from being overwritten.)
3. Create a bootable system disk. (Refer to Windows online help for information on creating a bootable system disk.)
4. Download the Flash Utility and new BIOS file from the manufacturer's Web site. Copy these files to the system diskette you created in Step 3.
5. Turn off your computer and insert the system diskette in your computer's diskette drive. (You might need to run the Setup Utility and change the boot priority items on the Advanced BIOS Features Setup page, to force your computer to boot from the floppy diskette drive first.)
6. At the A:\ prompt, type the Flash Utility program name and press <Enter>. You see a screen similar to the following:

|   |                      |
|---|----------------------|
| FLASH MEMORY WRITER V7.33                   |                      |
| (C) Award Software 1999 All Rights Reserved |                      |
| For (MAINBOARD NAME)                        | DATE: 10/26/2000     |
| Flash Type                                  |                      |
| File Name to Program :                      | <input type="text"/> |
| Error Message                               |                      |

7. Type the filename of the new BIOS in the "File Name to Program" text box. Follow the onscreen directions to update the mainboard BIOS.
8. When the installation is complete, remove the floppy diskette from the diskette drive and restart your computer. If your mainboard has a Flash BIOS jumper, reset the jumper to protect the newly installed BIOS from being overwritten.

---

## Using BIOS

When you start the Setup Utility, the main menu appears. The main menu of the Setup Utility displays a list of the options that are available. A highlight indicates which option is currently selected. Use the cursor arrow keys to move the highlight to other options. When an option is highlighted, execute the option by pressing <Enter>.

Some options lead to pop-up dialog boxes that prompt you to verify that you wish to execute that option. Other options lead to dialog boxes that prompt you for information.

Some options (marked with a triangle ►) lead to submenus that enable you to change the values for the option. Use the cursor arrow keys to scroll through the items in the submenu.

In this manual, default values are enclosed in parenthesis. Submenu items are denoted by a triangle ►.

## Standard CMOS Feature

This option displays basic information about your system.

Phoenix – AwardBIOS CMOS Setup Utility  
Standard CMOS Feature

|                        |                   |  |
|------------------------|-------------------|--|
| Date (mm:dd:yy)        | Tue, July 11 2001 | Item Help                                |
| Time (hh:mm:ss)        | 12 : 8 : 59       |  |
| ▶ IDE Primary Master   |                   | Menu Level ▶                             |
| ▶ IDE Primary Slave    |                   | Change the day, month, year and century. |
| ▶ IDE Secondary Master |                   |  |
| ▶ IDE Secondary Slave  |                   |  |
| Drive A                | [1.44M, 3.5 in.]  |  |
| Drive B                | [None]            |  |
|                        | Video             |  |
| [EGA/VGA]              |                   |  |
| Halt On                | [But keyboard]    |  |
| Base Memory            | 640K              |  |
| Extended Memory        | 31744K            |  |
| Total Memory           | 32768K            |  |

↑↓→← : Move    Enter : Select    +/-/PU/PD:Value:    F10: Save    ESC: Exit    F1:General Help  
F5:Previous Values    F6:Fail-Safe Defaults    F7:Optimized Defaults

### Date and Time

The Date and Time items show the current date and time on the computer. If you are running a Windows OS, these items are automatically updated whenever you make changes to the Windows Date and Time Properties utility.

### ▶ IDE Devices (None)

Your computer has two IDE channels (Primary and Secondary) and each channel can be installed with one or two devices (Master and Slave). Use these items to configure each device on the IDE channel.

Press <Enter> to display the IDE submenu:

Phoenix – AwardBIOS CMOS Setup Utility  
IDE Primary Master

|                                |               |   |
|--------------------------------|---------------|---|
| IDE HDD Auto-Detection         | [Press Enter] | Item Help   |
| IDE Primary Master Access Mode | [Auto]        |   |
| Capacity                       | 0 MB          | Menu Level ▶▶   |
| Cylinder                       | 0             | To auto-detect the HDD's size, head ... on this channel |
| Head                           | 0             |   |
| Precomp                        | 0             |   |
| Landing Zone                   | 0             |   |
| Sector                         | 0             |   |

↑↓→← : Move    Enter : Select    +/-/PU/PD:Value:    F10: Save    ESC: Exit    F1:General Help  
F5:Previous Values    F6:Fail-Safe Defaults    F7:Optimized Defaults

### **IDE HDD Auto-Detection**

Press <Enter> while this item is highlighted to prompt the Setup Utility to automatically detect and configure an IDE device on the IDE channel.

---

**Note:** If you are setting up a new hard disk drive that supports LBA mode, more than one line will appear in the parameter box. Choose the line that lists LBA for an LBA drive.

---

### **IDE Primary/Secondary Master/Slave**

Leave this item at Auto to enable the system to automatically detect and configure IDE devices on the channel. If it fails to find a device, change the value to Manual and then manually configure the drive by entering the characteristics of the drive in the items described below.

Refer to your drive's documentation or look on the drive casing if you need to obtain this information. If no device is installed, change the value to None.

---

**Note:** Before attempting to configure a hard disk drive, ensure that you have the configuration information supplied by the manufacturer of your hard drive. Incorrect settings can result in your system not recognizing the installed hard disk.

---

### **Access Mode**

This item defines ways that can be used to access IDE hard disks such as LBA (Large Block Addressing). Leave this value at Auto and the system will automatically decide the fastest way to access the hard disk drive.

Press <Esc> to return to the Standard CMOS Features page.

### **Drive A/Drive B (1.44M, 3.5 in./None)**

These items define the characteristics of any diskette drive attached to the system. You can connect one or two diskette drives.

### **Floppy 3 Mode Support (Disabled)**

Floppy 3 mode refers to a 3.5-inch diskette with a capacity of 1.2 MB. Floppy 3 mode is sometimes used in Japan.

### **Video (EGA/VGA)**

This item defines the video mode of the system. This mainboard has a built-in VGA graphics system; you must leave this item at the default value.

### **Halt On (But keyboard)**

This item defines the operation of the system POST (Power On Self Test) routine. You can use this item to select which types of errors in the POST are sufficient to halt the system.

### **Base Memory, Extended Memory, and Total Memory**

These items are automatically detected by the system at start up time. These are display-only fields. You cannot make changes to these fields.

## Advanced BIOS Features

This option defines advanced information about your system.

Phoenix – AwardBIOS CMOS Setup Utility  
Advanced BIOS Features

|                              |            |  |   |
|------------------------------|------------|--|---|
| CPU Internal Cache           | [Enabled]  |  | Item Help   |
| External Cache               | [Enabled]  |  | Menu Level ▶  |
| CPU L2 Cache ECC Checking    | [Enabled]  |  | Allows you to choose the VIRUS warning feature for IDE Hard Disk boot sector protection. If this function is enabled and someone attempts to write data into this area, BIOS will show a warning message on screen and alarm beep |
| Processor Number Feature     | [Enabled]  |  |   |
| Quick Power On Self Test     | [Enabled]  |  |   |
| First Boot Device            | [Floppy]   |  |   |
| Second Boot Device           | [HDD-0]    |  |   |
| Third Boot Device            | [CD-ROM]   |  |   |
| Boot Other Device            | [Enabled]  |  |   |
| Swap Floppy Drive            | [Disabled] |  |   |
| Boot Up Floppy Seek          | [Disabled] |  |   |
| Boot Up NumLock Status       | [On]       |  |   |
| Gate A20 Option              | [Fast]     |  |   |
| ATA 66/100 IDE Cable Msg     | [Disabled] |  |   |
| Typematic Rate Setting       | [Disabled] |  |   |
| x Typematic Rate (Chars/Sec) | 6          |  |   |
| x Typematic Delay (Msec)     | 250        |  |   |
| Security Option              | [Setup]    |  |   |

↑↓ : Move    ← : Previous Values    Enter : Select    +/-/PU/PD:Value:    F10: Save    ESC: Exit    F1:General Help  
 F6:Fail-Safe Defaults    F7:Optimized Defaults

### CPU Internal Cache (Enabled)

All processors that can be installed in this mainboard use internal level 1 (L1) cache memory to improve performance. Leave this item at the default value for better performance.

### External Cache (Enabled)

Most processors that can be installed in this system use external level 2 (L2) cache memory to improve performance. Leave this item at the default value for better performance.

### CPU L2 Cache ECC Checking (Enabled)

This item enables or disables ECC (Error Correction Code) error checking on the CPU cache memory. We recommend that you leave this item at the default value.

### Processor Number Feature (Enabled)

Some new processors are installed with a unique processor number. This number may be used for verification in Internet transactions and e-commerce. If you prefer not to use or distribute the unique processor number, disable this item to suppress the processor number.

### Quick Power On Self Test (Enabled)

Enable this item to shorten the power on testing (POST) and have your system start up faster. You might like to enable this item after you are confident that your system hardware is operating smoothly.

### **First/Second/Third Boot Device (Floppy/HDD-0/CD-ROM)**

Use these three items to select the priority and order of the devices that your system searches for an operating system at start-up time.

### **Boot Other Device (Enabled)**

When enabled, the system searches all other possible locations for an operating system if it fails to find one in the devices specified under the First, Second, and Third boot devices.

### **Swap Floppy Drive (Disabled)**

If you have two floppy diskette drives in your system, this item allows you to swap the assigned drive letters so that drive A becomes drive B, and drive B becomes drive A.

### **Boot Up Floppy Seek (Disabled)**

If this item is enabled, it checks the size of the floppy disk drives at start-up time. You don't need to enable this item unless you have a legacy diskette drive with 360K capacity.

### **Boot Up NumLock Status (On)**

This item defines if the keyboard Num Lock key is active when your system is started.

### **Gate A20 Option (Fast)**

This item defines how the system handles legacy software that was written for an earlier generation of processors. Leave this item at the default value.

### **ATA 66/100 IDE Cable Msg (Disabled)**

Enables or disables the ATA 66/100 IDE Cable Msg. This message will appear during reboot when you use 40-pin cable on your 66/100 hard disks.

### **Typematic Rate Setting (Disabled)**

If this item is enabled, you can use the following two items to set the typematic rate and the typematic delay settings for your keyboard.

- **Typematic Rate (Chars/Sec):** Use this item to define how many characters per second are generated by a held-down key.
- **Typematic Delay (Msec):** Use this item to define how many milliseconds must elapse before a held-down key begins generating repeat characters.

### **Security Option (Setup)**

If you have installed password protection, this item defines if the password is required at system start up, or if it is only required when a user tries to enter the Setup Utility.

### **APIC Mode (Enabled)**

This item allows you to enable or disable the APIC (Advanced Programmable Interrupt Controller) mode. APIC provides symmetric multi-processing (SMP) for systems, allowing support for up to 60 processors.

### OS Select For DRAM > 64 MB (Non-OS2)

This item is only required if you have installed more than 64 MB of memory and you are running the OS/2 operating system. Otherwise, leave this item at the default.

### HDD S.M.A.R.T Capability (Disabled)

The S.M.A.R.T. (Self-Monitoring, Analysis, and Reporting Technology) system is a diagnostics technology that monitors and predicts device performance. S.M.A.R.T. software resides on both the disk drive and the host computer.

The disk drive software monitors the internal performance of the motors, media, heads, and electronics of the drive. The host software monitors the overall reliability status of the drive. If a device failure is predicted, the host software, through the Client WORKS S.M.A.R.T applet, warns the user of the impending condition and advises appropriate action to protect the data.

### Video BIOS Shadow (Enabled)

This function, when enabled allows VGA BIOS to be copied to the system DRAM for enhanced performance.

### Small Logo (EPA) Show (Disabled)

Determines whether or not the EPA logo appears during boot up.

## Advanced Chipset Features

These items define critical timing parameters of the mainboard. You should leave the items on this page at their default values unless you are very familiar with the technical specifications of your system hardware. If you change the values incorrectly, you may introduce fatal errors or recurring instability into your system.

### Phoenix – AwardBIOS CMOS Setup Utility Advanced Chipset Features

|                            |               |              |
|----------------------------|---------------|--------------|
| ▶ DRAM Clock/Drive Control | [Press Enter] | Item Help    |
| ▶ AGP & P2P Bridge Control | [Press Enter] |              |
| ▶ CPU & PCI Bus Control    | [Press Enter] | Menu Level ▶ |
| Memory Hole                | [Disabled]    |              |
| System BIOS Cacheable      | [Disabled]    |              |
| Video RAM Cacheable        | [Disabled]    |              |
| BIOS Write Protect         | [Disabled]    |              |

↑↓ → ← : Move    Enter : Select    +/-/PU/PD:Value:    F10: Save    ESC: Exit    F1:General Help  
F5:Previous Values    F6:Fail-Safe Defaults    F7:Optimized Defaults

## ► DRAM Clock/Drive Control

Scroll to this item and press <Enter> to view the following screen:

Phoenix – AwardBIOS CMOS Setup Utility  
DRAM Clock/Drive Control

|                            |               | Item Help    |
|----------------------------|---------------|--------------|
| Current FSB Frequency      |               |              |
| Current DRAM Frequency     |               |              |
| DRAM Clock                 | [By SPD]      | Menu Level ► |
| DRAM Timing                | [Auto by SPD] |              |
| DRAM CAS Latency           | [2.5]         |              |
| Bank Interleave            | [Disabled]    |              |
| Precharge to Active (Trp)  | [3T]          |              |
| Active to Precharge (Tras) | [6T]          |              |
| Active to CMD (Trcd)       | [3T]          |              |
| DRAM Burst Length          | [4]           |              |
| DRAM Queue Depth           | [4 level]     |              |
| DRAM Command Rate          | [2T Command]  |              |

↑↓→← : Move    Enter : Select    +/-/PU/PD:Value:    F10: Save    ESC: Exit    F1:General Help  
F5:Previous Values    F6:Fail-Safe Defaults    F7:Optimized Defaults

### **Current FSB Frequency**

This item displays the frontside bus (FSB) frequency. This is a display-only item. You cannot make changes to this field.

### **Current DRAM Frequency**

This item displays the memory (DRAM) frequency. This is a display-only item. You cannot make changes to this field.

### **DRAM Clock (By SPD)**

This item enables you to manually set the DRAM Clock. We recommend that you leave this item at the default value.

### **DRAM Timing (Auto by SPD)**

Set this By SPD to enable the system to automatically set the SDRAM timing by SPD (Serial Presence Detect). SPD is an EEPROM chip on the DIMM module that stores information about the memory chips it contains, including size, speed, voltage, row and column addresses, and manufacturer. If you disable this item, you can use the following three items to manually set the timing parameters for the system memory

### **DRAM CAS Latency (2.5)**

Enables you to select the CAS latency time in HCLKs of 2/2 or 3/3. The value is set at the factory depending on the DRAM installed. Do not change the values in this field unless you change specifications of the installed DRAM or the installed CPU. The options are "2" and "2.5" default.

### **Bank Interleave (Disabled)**

Enable this item to increase memory speed. When enabled, separate memory banks are set for odd and even addresses and the next byte of memory can be accessed while the current byte is being refreshed.

**Precharge to Active (3T/4T)**

This item is used to designate the minimum Row Precharge time of the SDRAM devices on the module.

DRAM must continually be refreshed or it will lose its data. Normally, DRAM is refreshed entirely as the result of a single request. This option allows you to determine the number of CPU clocks allocated for the Row Address Strobe (RAS) to accumulate its charge before the DRAM is refreshed. If insufficient time is allowed, refresh may be incomplete and data lost.

**Active to Precharge (6T/10T)**

This item specifies the number of clock cycles needed after a bank active command before a precharge can occur.

**Active to CMD (3T)**

This item specifies the minimum required delay between activation of different rows.

**DRAM Burst Len (4)**

This item describes which burst lengths are supported by the devices on the mainboard. 1 level can provide faster performance but may result in instability whereas 8 level gives the most stable but slowest performance.

**DRAM Queue Depth (4 level)**

This item sets the depth of the DRAM queue used for CPU's cache.

**DRAM Command Rate (2T command)**

This item enables you to specify the waiting time for the CPU to issue the next command after issuing the command to the DDR memory. We recommend that you leave this item at the default value.

**Write Recovery Time (3T)**

This item controls the timing between write and precharge command.

Press <Esc> to return to the Advanced Chipset Features screen.



## ► AGP & P2P Bridge Control

Scroll to this item and press <Enter> to view the following screen:

Phoenix – AwardBIOS CMOS Setup Utility  
AGP & P2P Bridge Control

|                       |            |              |
|-----------------------|------------|--------------|
| AGP Aperture Size     | [125 MB]   | Item Help    |
| AGP Mode              | [4X]       |              |
| AGP Driving Control   | [Auto]     | Menu Level ► |
| x AGP Driving Value   | DA         |              |
| AGP Fast Write        | [Disabled] |              |
| AGP Master 1 WS Write | [Disabled] |              |
| AGP Master WS Read    | [Disabled] |              |

↑↓→← : Move    Enter : Select    +/-/PU/PD:Value:    F10: Save    ESC: Exit    F1:General Help  
F5:Previous Values    F6:Fail-Safe Defaults    F7:Optimized Defaults

### **AGP Aperture Size (128 MB)**

This item defines the size of the aperture if you use an AGP graphics adapter. The AGP aperture refers to a section of the PCI memory address range used for graphics memory. We recommend that you leave this item at the default value.

### **AGP Mode (4X)**

This item allows you to enable or disable the caching of display data for the processor video memory. Enabling AGP-4X Mode can greatly improve the display speed. Disable this item if your graphics display card does not support this feature.

### **AGP Driving Control (Auto)**

This item is used to signal driving current on AGP cards to auto or manual. Some AGP cards need stronger than normal driving current in order to operate. We recommend that you set this item to the default.

- **AGP Driving Value:** When AGP Driving Control is set to Manual, use this item to set the AGP current driving value.

### **AGP Fast Write (Disabled)**

This item lets you enable or disable the caching of display data for the video memory of the processor. Enabling this item can greatly improve the display speed. Disable this item if your graphics display card does not support this feature.

### **AGP Master 1 WS Write (Disabled)**

This implements a single delay when writing to the AGP Bus. By default, two-wait states are used by the system, providing greater stability.

### **AGP Master 1 WS Read (Disabled)**

This implements a single delay when reading to the AGP Bus. By default, two-wait states are used by the system, allowing for greater stability.

Press <Esc> to return to the Advanced Chipset Features screen.

### ► CPU & PCI Bus Control

Scroll to this item and press <Enter> to view the following screen:

Phoenix – AwardBIOS CMOS Setup Utility  
CPU & PCI Bridge Control

|                        |            |              |
|------------------------|------------|--------------|
| PCI1 Master 0 WS Write | [Enabled]  | Item Help    |
| PCI2 Master 0 WS Write | [Enabled]  |              |
| PCI1 Post Write        | [Enabled]  | Menu Level ► |
| PCI2 Post Write        | [Enabled]  |              |
| PCI Delay Transaction  | [Disabled] |              |

↑↓→← : Move    Enter : Select    +/-/PU/PD:Value:    F10: Save    ESC: Exit    F1:General Help  
F5:Previous Values    F6:Fail-Safe Defaults    F7:Optimized Defaults

#### **PCI 1/2 Master 0 WS Write (Enabled)**

When enabled, writes to the PCI bus are executed with zero wait states, providing faster data transfer.

#### **PCI 1/2 Post Write (Enabled)**

When enabled, writes from the CPU to PCU bus are buffered, to compensate for the speed differences between the CPU and PCI bus. When disabled, the writes are not buffered and the CPU must wait until the write is complete before starting another write cycle.

#### **PCI Delay Transaction (Disabled)**

The mainboard's chipset has an embedded 32-bit post write buffer to support delay transactions cycles. Select Enabled to support compliance with PCI specification version 2.1.

Press <Esc> to return to the Advanced Chipset Features screen.

#### **Memory Hole (Disabled)**

This item is used to reserve memory space for ISA expansion cards that require it.

#### **System BIOS/Video RAM Cacheable (Disabled)**

These items allow the video and system to be cached in memory for faster execution. Leave these items at the default value for better performance.

#### **BIOS Write Protect (Disabled)**

Use this item to enable or disable the BIOS Write Protect.

## Integrated Peripherals

These options display items that define the operation of peripheral components on the system's input/output ports.

Phoenix – AwardBIOS CMOS Setup Utility  
Integrated Peripherals

|                         |               | Item Help    |
|-------------------------|---------------|--------------|
| ▶ VIA OnChip IDE Device | [Press Enter] |              |
| ▶ VIA OnChip PCI Device | [Press Enter] |              |
| ▶ VIA Super I/O Device  | [Press Enter] | Menu Level ▶ |
| Init Display First      | [PCI Slot]    |              |
| OnChip USB Controller   | [All Enabled] |              |
| USB Keyboard Support    | [Disabled]    |              |
| USB Mouse Support       | [Disabled]    |              |
| Onboard RAID Device     | [Enabled]     |              |
| Onboard 1394 Device     | [Enabled]     |              |
| IDE HDD Block Mode      | [Enabled]     |              |
| PWRON After PWR-Fail    | [Off]         |              |

↑↓→← : Move    Enter : Select    +/-/PU/PD:Value:    F10: Save    ESC: Exit    F1:General Help  
F5:Previous Values    F6:Fail-Safe Defaults    F7:Optimized Defaults

### ▶ VIA OnChip IDE Device

Scroll to this item and press <Enter> to view the following screen:

Phoenix – AwardBIOS CMOS Setup Utility  
VIA OnChip IDE Device

|                     |             | Item Help     |
|---------------------|-------------|---------------|
| OnChip IDE Channel0 | [Enabled]   |               |
| OnChip IDE Channel1 | [Enabled]   |               |
| IDE Prefetch Mode   | [Enabled]   | Menu Level ▶▶ |
| Primary Master      | PIO [Auto]  |               |
| Primary Slave       | PIO [Auto]  |               |
| Secondary Master    | PIO [Auto]  |               |
| Secondary Slave     | PIO [Auto]  |               |
| Primary Master      | UDMA [Auto] |               |
| Primary Slave       | UDMA [Auto] |               |
| Secondary Master    | UDMA [Auto] |               |
| Secondary Slave     | UDMA [Auto] |               |

↑↓→← : Move    Enter : Select    +/-/PU/PD:Value:    F10: Save    ESC: Exit    F1:General Help  
F5:Previous Values    F6:Fail-Safe Defaults    F7:Optimized Defaults

### **On-Chip IDE Channel 0/1 (Enabled)**

Use these items to enable or disable the PCI IDE channels that are integrated on the mainboard.

### **IDE Prefetch Mode (Enabled)**

The onboard IDE drive interface supports IDE prefetching, for faster drive access. If you install a primary and secondary add-in IDE interface, set this

field to Disabled if the interface does not support prefetching.

**IDE Primary/Secondary Master/Slave PIO (Auto)**

Each IDE channel supports a master device and a slave device. These four items let you assign which kind of PIO (Programmed Input/Output) is used by IDE devices. Choose Auto to let the system auto detect which PIO mode is best, or select a PIO mode from 0-4.

**IDE Primary/Secondary Master/Slave UDMA (Auto)**

Each IDE channel supports a master device and a slave device. This mainboard supports UltraDMA technology, which provides faster access to IDE devices.

If you install a device that supports UltraDMA, change the appropriate item on this list to Auto. You may have to install the UltraDMA driver supplied with this mainboard in order to use an UltraDMA device.

Press <Esc> to return to the Integrated Peripherals screen.

► **VIA OnChip PCI Device**

Scroll to this item and press <Enter> to view the following screen:

Phoenix – AwardBIOS CMOS Setup Utility  
VIA OnChip PCI Device

|                      |            |               |
|----------------------|------------|---------------|
| VIA-3058 AC97 Audio  | [Auto]     | Item Help     |
| VIA-3068 MC97 Modem  | [Auto]     |               |
| VIA-3043 OnChip LAN  | [Enabled]  | Menu Level ►► |
| Onboard LAN Boot ROM | [Disabled] |               |

↑↓→← : Move    Enter : Select    +/-/PU/PD:Value:    F10: Save    ESC: Exit    F1:General Help  
F5:Previous Values    F6:Fail-Safe Defaults    F7:Optimized Defaults

**VIA-3058 AC97 Audio (Auto)**

Enables and disables the onboard audio chip. Disable this item if you are going to install a PCI audio add-in card.

**VIA-3068 MC97 Modem (Auto)**

Enables and disables the onboard modem. Disable this item if you are going to install an external modem.

**VIA-3043 OnChip LAN (Enabled)**

Enables and disables the onboard LAN.

**Onboard LAN Boot ROM (Disabled)**

Use this item to enable and disable the booting from the onboard LAN or a

network add-in card with a remote boot ROM installed.

Press <Esc> to return to the Integrated Peripherals screen.

### ► SuperIO Device

Scroll to this item and press <Enter> to view the following screen:

| Phoenix - AwardBIOS CMOS Setup Utility |            |               |
|--|------------|---------------|
| SuperIO Device                         |            |               |
| Onboard FDC Controller                 | [Enabled]  | Item Help     |
| Onboard Serial Port 1                  | [3F8/IRQ4] |               |
| Onboard Serial Port 2                  | [2F8/IRQ3] | Menu Level ►► |
| UART Mode Select                       | [Normal]   |               |
| UR2 Duplex Mode                        | [Half]     |               |
| Onboard Parallel Port                  | [378/IRQ7] |               |
| Parallel Port Mode                     | [ECP]      |               |
| ECP Mode Use DMA                       | [3]        |               |

↑↓→← : Move    Enter : Select    +/-/PU/PD:Value:    F10: Save    ESC: Exit    F1:General Help  
F5:Previous Values    F6:Fail-Safe Defaults    F7:Optimized Defaults

#### **Onboard FDC Controller (Enabled)**

This option enables the onboard floppy disk drive controller.

#### **Onboard Serial Port 1 (3F8/IRQ4)**

This option is used to assign the I/O address and interrupt request (IRQ) for the onboard serial port 1 (COM1).

#### **Onboard Serial Port 2 (2F8/IRQ3)**

This option is used to assign the I/O address and interrupt request (IRQ) for the onboard serial port 2 (COM2).

#### **UART Mode Select (Normal)**

This field is available if the Onboard Serial Port 2 field is set to any option but Disabled. UART Mode Select enables you to select the infrared communication protocol: Normal (default), IrDA, or ASKIR. IrDA is an infrared communication protocol with a maximum baud rate up to 115.2K bps. ASKIR is Sharp's infrared communication protocol with a maximum baud rate up to 57.6K bps.

#### **UR2 Duplex Mode (Half)**

This field is available when UART 2 Mode is set to either ASKIR or IrDA. This item enables you to determine the infrared function of the onboard infrared chip. The options are Full and Half (default).

Full-duplex means that you can transmit and send information simultaneously. Half-duplex is the transmission of data in both directions, but only one direction at a time.

**Onboard Parallel Port (378/IRQ7)**

This option is used to assign the I/O address and interrupt request (IRQ) for the onboard parallel port.

**Parallel Port Mode (ECP)**

Enables you to set the data transfer protocol for your parallel port. There are four options: SPP (Standard Parallel Port), EPP (Enhanced Parallel Port), ECP (Extended Capabilities Port) and ECP+EPP.

SPP allows data output only. Extended Capabilities Port (ECP) and Enhanced Parallel Port (EPP) are bi-directional modes, allowing both data input and output. ECP and EPP modes are only supported with EPP- and ECP-aware peripherals.

**ECP Mode Use DMA (3)**

When the onboard parallel port is set to ECP mode, the parallel port can use DMA 3 or DMA 1.

**Game Port Address (201)**

This item sets the I/O address for the game port.

**Midi Port Address (330)**

This item sets the I/O address for the Midi function.

**Midi Port IRQ (10)**

This item sets the interrupt request for the Midi function.

Press <Esc> to return to the Integrated Peripherals screen.

**Init Display First (PCI Slot)**

Use this item to specify whether your graphics adapter is installed in one of the PCI slots or is integrated on the mainboard.

**OnChip USB Controller (All Enabled)**

Enable this item if you plan to use the Universal Serial Bus ports on this mainboard.

**USB Keyboard Support (Disabled)**

Enable this item if you plan to use a keyboard connected through the USB port in a legacy operating system (such as DOS) that does not support Plug and Play.

**USB Mouse Support (Disabled)**

Enable this item if you plan to use a USB mouse.

**Onboard RAID Device (Enabled)**

Enable this item if you plan to use the RAID device.

**Onboard 1394 Device (Enabled)**

Enable this item if you plan to use the 1394 device.

**IDE HDD Block Mode (Enabled)**

Enable this field if your IDE hard drive supports block mode. Block mode en-

ables BIOS to automatically detect the optimal number of block read and writes per sector that the drive can support and improves the speed of access to IDE devices.

**PWRON After PWR-Fail (Off)**

This item enables your computer to automatically restart or return to its last operating status after power returns from a power failure.

**Power Management Setup**

This option lets you control system power management. The system has various power-saving modes including powering down the hard disk, turning off the video, suspending to RAM, and software power down that allows the system to be automatically resumed by certain events.

**Power Management Timeouts**

The power-saving modes can be controlled by timeouts. If the system is inactive for a time, the timeouts begin counting. If the inactivity continues so that the timeout period elapses, the system enters a power-saving mode. If any item in the list of Reload Global Timer Events is Enabled, then any activity on that item will reset the timeout counters to zero.

**Wake Up Calls**

If the system is suspended, or has been powered down by software, it can be resumed by a wake up call that is generated by incoming traffic to a modem, a LAN card, a PCI card, or a fixed alarm on the system realtime clock.

Phoenix – AwardBIOS CMOS Setup Utility  
Power Management Setup

|                             |                  |              |
|-----------------------------|------------------|--------------|
| ACPI function               | [Enabled]        | Item Help    |
| ACPI Suspend Type           | [S1(POS)]        |              |
| Power Management Option     | [User Define]    | Menu Level ▶ |
| HDD Power Down              | [Disable]        |              |
| Suspend Mode                | [Disable]        |              |
| Video Off Option            | [Suspend -> Off] |              |
| Video Off Method            | [DPMS Support]   |              |
| MODEM Use IRQ               | [3]              |              |
| Soft-Off by PWRBTN          | [Instant-Off]    |              |
| ▶ IRQ/Event Activity Detect | [Press Enter]    |              |

↑↓→← : Move    Enter : Select    +/-/PU/PD:Value:    F10: Save    ESC: Exit    F1:General  
 Help    F5:Previous Values    F6:Fail-Safe Defaults    F7:Optimized Defaults

**ACPI Function (Enabled)**

This mainboard supports ACPI (Advanced Configuration and Power management Interface). Use this item to enable or disable the ACPI feature.

---

**Note:** ACPI is a power management specification that makes hardware status information available to the operating system. ACPI enables a PC to turn its peripherals on and off for improved power management. It also allows the PC to be turned on and off by external devices, so that mouse or keyboard activity wakes up the computer.

---

### **ACPI Suspend Type (S1(POS))**

Use this item to define how your system suspends. In the default, S1(POS), the suspend mode is equivalent to a software power down. If you select S3 (STR), the suspend mode is a suspend to RAM - the system shuts down with the exception of a refresh current to the system memory.

### **Power Management Option (User Define)**

This item acts like a master switch for the power-saving modes and hard disk timeouts. If this item is set to Max Saving, power-saving modes occur after a short timeout. If this item is set to Min Saving, power-saving modes occur after a longer timeout. If the item is set to User Define, you can insert your own timeouts for the power-saving modes.

### **HDD Power Down (Disable)**

The IDE hard drive will spin down if it is not accessed within a specified length of time. Options are from 1 Min to 15 Min and Disable.

### **Suspend Mode (Disable)**

The CPU clock will be stopped and the video signal will be suspended if no Power Management events occur for a specified length of time. Full power function will return when a Power Management event is detected. Options are from 1 Min to 1 Hour and Disable.

### **Video Off Option (Suspend --> Off)**

This option defines if the video is powered down when the system is put into suspend mode.

### **Video Off Method (DPMS Support)**

This item defines how the video is powered down to save power. This item is set to DPMS (Display Power Management Software) by default.

### **MODEM Use IRQ (3)**

If you want an incoming call on a modem to automatically resume the system from a power-saving mode, use this item to specify the interrupt request line (IRQ) that is used by the modem. You might have to connect the fax/modem to the mainboard Wake On Modem connector for this feature to work.

### **Soft-Off by PWRBTN (Instant-Off)**

Under ACPI (Advanced Configuration and Power management Interface) you can create a software power down. In a software power down, the system can be resumed by Wake Up Alarms. This item lets you install a software power down that is controlled by the power button on your system. If the item is set to Instant-Off, then the power button causes a software power down. If the item is set to Delay 4 Sec. then you have to hold the power button down for four seconds to cause a software power down.



► **IRQ/Event Activity Detect**

Scroll to this item and press <Enter> to view the following screen:

Phoenix – AwardBIOS CMOS Setup Utility  
IRQ/Event Activity Detect

|                            |               |              |
|----------------------------|---------------|--------------|
| PS2KB WakeUp from S3/S4/S5 | [Disabled]    | Item Help    |
| PS2KB Wakeup Select        | [Hot key]     |              |
| PS2MS Wakeup from S3/S4/S5 | [Disabled]    | Menu Level ► |
| USB Resume from S3         | [Disabled]    |              |
| VGA                        | [OFF]         |              |
| LPT & COM                  | [LPT/COM]     |              |
| HDD & FDD                  | [ON]          |              |
| PCI Master                 | [OFF]         |              |
| PowerOn by PCI Card        | [Enabled]     |              |
| WOL/WOM Resume             | [Disabled]    |              |
| RTC Alarm Resume           | [Disabled]    |              |
| x Date (of Month)          | 0             |              |
| x Resume Time (hh:mm:ss)   | 0 0 0         |              |
| ► IRQs Activity Monitoring | [Press Enter] |              |

↑↓→← : Move    Enter : Select    +/-/PU/PD:Value:    F10: Save    ESC: Exit    F1:General Help  
F5:Previous Values    F6:Fail-Safe Defaults    F7:Optimized Defaults

This item opens a submenu that enables you to set events that will resume the system from a power saving mode.

**PS2KB WakeUp from S3/S4/S5 (Disabled)**

Enables you to allow keyboard activity to awaken the system from power saving mode.

**PS2KB Wakeup Select (Hot key)**

Enables you to choose either to press a keyboard hot key or be prompted for a password to wakeup the system from power saving mode.

**PS2MS WakeUp from S3/S4/S5 (Disabled)**

Enables you to allow mouse activity to awaken the system from power saving mode.

**USB Resume from S3 (Disabled)**

When set to Enabled, the system power will resume the system from a power saving mode if there is any USB port activity.

**VGA (Off)**

When set to On, the system power will resume the system from a power saving mode if there is any VGA activity.

**LPT & COM (LPT/COM)**

When this item is enabled, the system will restart the power-saving timeout counters when any activity is detected on the serial ports, or the parallel port.

**HDD & FDD (ON)**

When this item is enabled, the system will restart the power-saving timeout counters when any activity is detected on the hard disk drive or the floppy diskette drive.

**PCI Master (OFF)**

When set to Off, any PCI device set as the Master will not power on the system.

**PowerOn by PCI Card (Enabled)**

Use this item to enable PCI activity to wakeup the system from a power saving mode.

**WOL/WOM Resume (Disabled)**

Use this item to enable LAN or modem activity to wakeup the system from a power saving mode.

**RTC Alarm Resume (Disabled)**

When set to Enabled, additional fields become available and you can set the date (day of the month), hour, minute and second to turn on your system. When set to 0 (zero) for the day of the month, the alarm will power on your system every day at the specified time.

**▶▶ IRQs Activity Monitoring**

Scroll to this item and press <Enter> to view the following screen:

Phoenix – AwardBIOS CMOS Setup Utility  
IRQs Activity Monitoring

|                      |            |                |
|----------------------|------------|----------------|
| Primary INTR         | [ON]       | Item Help      |
| IRQ 3 (COM2)         | [Enabled]  | Menu Level ▶▶▶ |
| IRQ 4 (COM1)         | [Enabled]  |                |
| IRQ 5 (LPT2)         | [Enabled]  |                |
| IRQ 6 (Floppy Disk)  | [Enabled]  |                |
| IRQ 7 (LPT1)         | [Enabled]  |                |
| IRQ 8 (RTC Alarm)    | [Disabled] |                |
| IRQ 9 (IRQ2 Redir)   | [Disabled] |                |
| IRQ 10 (Reserved)    | [Disabled] |                |
| IRQ 11 (Reserved)    | [Disabled] |                |
| IRQ 12 (PS/2 Mouse)  | [Enabled]  |                |
| IRQ 13 (Coprocessor) | [Enabled]  |                |
| IRQ 14 (Hard Disk)   | [Enabled]  |                |
| IRQ 15 (Reserved)    | [Disabled] |                |

↑↓ → ← : Move Enter : Select +/-/PU/PD:Value: F10: Save ESC: Exit F1:General Help  
F5:Previous Values F6:Fail-Safe Defaults F7:Optimized Defaults

This screen enables you to set IRQs that will resume the system from a power saving mode.

Set any IRQ to Enabled to allow activity at the IRQ to wake up the system from a power saving mode.

Press <Esc> to return to the Power Management Setup screen.

## PNP/PCI Configurations

These options configure how PnP (Plug and Play) and PCI expansion cards operate in your system. Both the ISA and PCI buses on the Mainboard use system IRQs (Interrupt ReQuests) and DMAs (Direct Memory Access). You must set up the IRQ and DMA assignments correctly through the PnP/PCI Configurations Setup utility for the mainboard to work properly. Selecting PnP/PCI Configurations on the main program screen displays this menu:

Phoenix - AwardBIOS CMOS Setup Utility  
PnP/PCI Configurations

|                          |              |   |
|--------------------------|--------------|---|
| PNP OS Installed         | [No]         | Item Help<br>Menu Level ▶<br>Default is Disabled.<br>Select Enabled to reset Extended System Configuration Data (ESCD) when you exit Setup if you have installed a new add-on and the system reconfiguration has caused such a serious conflict that the OS cannot boot |
| Reset Configuration Data | [Disabled]   |   |
| Resources Controlled by  | [Auto(ESCD)] |   |
| x IRQ Resources          | Press Enter  |   |
| PCI/VGA Palette Snoop    | [Disabled]   |   |
| Assign IRQ For VGA       | [Enabled]    |   |
| Assign IRQ For USB       | [Enabled]    |   |

↑ ↓ → ← : Move    Enter : Select    +/-/PU/PD: Value:    F10: Save    ESC: Exit    F1: General Help  
F5: Previous Values    F6: Fail-Safe Defaults    F7: Optimized Defaults

### PNP OS Installed (No)

Setting this option to Yes allows the PnP OS (instead of BIOS) to assign the system resources such as IRQ and I/O address to the ISA PnP device. The default setting is No.

### Reset Configuration Data (Disabled)

If you enable this item and restart the system, any Plug and Play configuration data stored in the BIOS setup is cleared from memory. New updated data is created.

### Resources Controlled By (Auto(ESCD))

You should leave this item at the default Auto (ESCD). Under this setting, the system dynamically allocates resources to plug and play devices as they are required.

If you cannot get a legacy ISA (Industry Standard Architecture) expansion card to work properly, you might be able to solve the problem by changing this item to Manual, and then opening up the IRQ Resources and Memory Resources sub-menus.

In the IRQ Resources sub-menu, if you change any of the IRQ assignments to Legacy ISA, then that Interrupt Request Line is reserved for a legacy ISA expansion card. Press <Esc> to close the IRQ Resources sub-menu.

In the Memory Resources sub menu, use the first item Reserved Memory Base to set the start address of the memory you want to reserve for the ISA

expansion card. Use the second item Reserved Memory Length to set the amount of reserved memory. Press <Esc> to close the Memory Resources sub-menu.

**PCI/VGA Palette Snoop (Disabled)**

This item is designed to overcome some problems that can be caused by some non-standard VGA cards. This board includes a built-in VGA system that does not require palette snooping so you must leave this item disabled.

**Assign IRQ for VGA/USB (Enabled)**

Names the interrupt request (IRQ) line assigned to the USB/VGA (if any) on your system. Activity of the selected IRQ always awakens the system.

**PC Health Status**

On mainboards that support hardware monitoring, this item lets you monitor the parameters for critical voltages, critical temperatures, and fan speeds.

Phoenix – AwardBIOS CMOS Setup Utility  
PC Health Status

|                      |            |              |
|----------------------|------------|--------------|
| Shutdown Temperature | [Disabled] | Item Help    |
| CPU V-CORE           |            | Menu Level ▶ |
| + 2.5V               |            |              |
| + 3.3V               |            |              |
| + 5V                 |            |              |
| + 12V                |            |              |
| Voltage Battery      |            |              |
| Current System Temp  |            |              |
| Current CPU Temp     |            |              |
| CPUFAN1              |            |              |
| CASFAN1              |            |              |

↑↓→← : Move    Enter : Select    +/-/PU/PD:Value:    F10: Save    ESC: Exit    F1:General Help  
F5:Previous Values    F6:Fail-Safe Defaults    F7:Optimized Defaults

**Shutdown Temperature (Disabled)**

Enables you to set the maximum temperature the system can reach before powering down.

**System Component Characteristics**

These fields provide you with information about the systems current operating status. You cannot make changes to these fields.

## Frequency/Voltage Control

This item enables you to set the clock speed and system bus for your system. The clock speed and system bus are determined by the kind of processor you have installed in your system.

Phoenix – AwardBIOS CMOS Setup Utility  
Frequency/Voltage Control

|                          |           |              |
|--------------------------|-----------|--------------|
| Auto Detect DIMM/PCI Clk | [Enabled] | Item Help    |
| Spread Spectrum          | [Enabled] |              |
| CPU Clock                | [100]     | Menu Level ▶ |
| CPU Voltage Adjust       | [Normal]  |              |
| DIMM Voltage Adjust      | [Normal]  |              |

↑↓→← : Move    Enter : Select    +/-/PU/PD:Value:    F10: Save    ESC: Exit    F1:General Help  
F5:Previous Values    F6:Fail-Safe Defaults    F7:Optimized Defaults

### Auto Detect DIMM/PCI Clk (Enabled)

When this item is enabled, BIOS will disable the clock signal of free DIMM and PCI slots.

### Spread Spectrum (Enabled)

If you enable spread spectrum, it can significantly reduce the EMI (Electro-Magnetic Interference) generated by the system.

### CPU Clock (100)

This item allows you to adjust the CPU clock to 100Mhz or 200MHz. You can key-in the numbers within the range to make a precise and ideal adjustment.

### CPU Voltage Adjust (Normal)

This item allows you to control the voltage delivered to the CPU core. It is not recommended that you change the default setting. But expert overclockers can very well fine-tune the voltage to aid in speed and stability of an over-clocked processor.

### DIMM Voltage Adjust (Normal)

This item adjusts the voltage delivered to the DIMM memory.

## Load Fail-Safe Defaults

This option opens a dialog box that lets you install fail-safe defaults for all appropriate items in the Setup Utility:

Press <Y> and then <Enter> to install the defaults. Press <N> and then <Enter> to not install the defaults. The fail-safe defaults place no great demands on the system and are generally stable. If your system is not functioning correctly, try installing the fail-safe defaults as a first step in getting your system working properly again. If you only want to install fail-safe defaults for a specific option, select and display that option, and then press <F6>.

## Load Optimized Defaults

This option opens a dialog box that lets you install optimized defaults for all appropriate items in the Setup Utility. Press <Y> and then <Enter> to install the defaults. Press <N> and then <Enter> to not install the defaults. The optimized defaults place demands on the system that may be greater than the performance level of the components, such as the CPU and the memory. You can cause fatal errors or instability if you install the optimized defaults when your hardware does not support them. If you only want to install setup defaults for a specific option, select and display that option, and then press <F7>.

## Set Supervisor/User Password

When this function is selected, the following message appears at the center of the screen to assist you in creating a password.

### ENTER PASSWORD

Type the password, up to eight characters, and press <Enter>. The password typed now will clear any previously entered password from CMOS memory. You will be asked to confirm the password. Type the password again and press <Enter>. You may also press <Esc> to abort the selection.

To disable password, just press <Enter> when you are prompted to enter password. A message will confirm the password being disabled. Once the password is disabled, the system will boot and you can enter BIOS Setup freely.

### PASSWORD DISABLED

If you have selected **System** in "Security Option" of "BIOS Features Setup" menu, you will be prompted for the password every time the system reboots or any time you try to enter BIOS Setup.

If you have selected **Setup** at "Security Option" from "BIOS Features Setup" menu, you will be prompted for the password only when you enter BIOS Setup.

Supervisor Password has higher priority than User Password. You can use Supervisor Password when booting the system or entering BIOS Setup to modify all settings. Also you can use User Password when booting the system or entering BIOS Setup but can not modify any setting if Supervisor Password is enabled.

## **Save & Exit Setup**

Highlight this item and press <Enter> to save the changes that you have made in the Setup Utility and exit the Setup Utility. When the Save and Exit dialog box appears, press <Y> to save and exit, or press <N> to return to the main menu:

## **Exit Without Saving**

Highlight this item and press <Enter> to discard any changes that you have made in the Setup Utility and exit the Setup Utility. When the Exit Without Saving dialog box appears, press <Y> to discard changes and exit, or press <N> to return to the main menu.

---

**Note:** If you have made settings that you do not want to save, use the "Exit Without Saving" item and press <Y> to discard any changes you have made.

---

This concludes Chapter 3. Refer to the next chapter for information on the software supplied with the mainboard.

## Chapter 4

# Using the Mainboard Software

---

### About the Software CD-ROM

The support software CD-ROM that is included in the mainboard package contains all the drivers and utility programs needed to properly run the bundled products. Below you can find a brief description of each software program, and the location for your mainboard version. More information on some programs is available in a README file, located in the same directory as the software.

---

**Note:** Never try to install software from a folder that is not specified for use with your mainboard.

---

Before installing any software, always inspect the folder for files named README.TXT, INSTALL.TXT, or something similar. These files may contain important information that is not included in this manual.

---

### Auto-installing under Windows 98/ME/2000/XP

The Auto-install CD-ROM makes it easy for you to install the drivers and software for your mainboard.

---

**Note:** If the Auto-install CD-ROM does not work on your system, you can still install drivers through the file manager for your OS (for example, Windows Explorer). Refer to Utility Folder Installation Notes later in this chapter.

---

The support software CD-ROM disc loads automatically under Windows 98/ME/2000/XP. When you insert the CD-ROM disc in the CD-ROM drive, the autorun feature will automatically bring up the install screen. The screen has three buttons on it, Setup, Browse CD and Exit.



---

**Note:** If the opening screen doesn't appear, double-click the file "setup.exe" in the root directory.

---



## Setup Tab

|                  |   |
|------------------|---|
| <b>Setup</b>     | Click the <b>Setup</b> button to run the software installation program. Select from the menu which software you want to install.  |
| <b>Browse CD</b> | <p>The <b>Browse CD</b> button is the standard Windows command that allows you to open Windows Explorer and show the contents of the support CD.</p> <p>Before installing the software from Windows Explorer, look for a file named README.TXT, INSTALL.TXT or something similar. This file may contain important information to help you install the software correctly.</p> <p>Some software is installed in separate folders for different operating systems, such as DOS, WIN NT, or WIN98/95. Always go to the correct folder for the kind of OS you are using.</p> <p>To install the software, execute a file named SETUP.EXE or INSTALL.EXE by double-clicking the file and then following the instructions on the screen.</p> |
| <b>Exit</b>      | The <b>Exit</b> button closes the Auto Setup window.  |

## Application Tab

Lists the software utilities that are available on the CD.

## Read Me Tab

Displays the path for all software and drivers available on the CD.

## Running Setup

Follow these instructions to install device drivers and software for the mainboard:

1. Click **Setup**. The installation program begins:



---

**Note:** The following screens are examples only. The screens and driver lists will be different according to the mainboard you are installing.

---

The mainboard identification is located in the upper left-hand corner.

2. Click **Next**. The following screen appears:

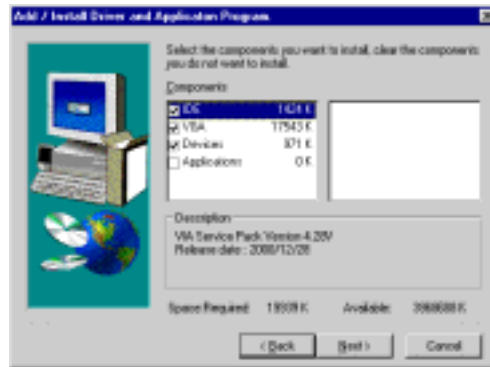

3. Check the box next to the items you want to install. The default options are recommended.
4. Click **Next** run the Installation Wizard. An item installation screen appears:



5. Follow the instructions on the screen to install the items.

Drivers and software are automatically installed in sequence. Follow the on-screen instructions, confirm commands and allow the computer to restart a few times to complete the installation.

---

## Manual Installation

Insert the CD in the CD-ROM drive and locate the PATH.DOC file in the root directory. This file contains the information needed to locate the drivers for your mainboard.

Look for the chipset and mainboard model; then browse to the directory and path to begin installing the drivers. Most drivers have a setup program (SETUP.EXE) that automatically detects your operating system before installation. Other drivers have the setup program located in the operating system subfolder.

If the driver you want to install does not have a setup program, browse to the operating system subfolder and locate the readme text file (README.TXT or README.DOC) for information on installing the driver or software for your operating system.

---

## Utility Software Reference

All the utility software available from this page is Windows compliant. They are provided only for the convenience of the customer. The following software is furnished under license and may only be used or copied in accordance with the terms of the license.

---

**Note:** These software(s) are subject to change at anytime without prior notice.  
Please refer to the support CD for available software.

---

### AWARD Flash Memory Utility

This utility lets you erase the system BIOS stored on a Flash Memory chip on the mainboard, and lets you copy an updated version of the BIOS to the chip. Proceed with caution when using this program. If you erase the current BIOS and fail to write a new BIOS, or write a new BIOS that is incorrect, your system will malfunction. Refer to Chapter 3, *Using BIOS* for more information.

### WinFlash Utility

The Award WinFlash utility is a Windows version of the DOS Award BIOS flash writer utility. The utility enables you to flash the system BIOS stored on a Flash Memory chip on the mainboard while in a Windows environment. This utility is currently available for WINXP\ME\2000\98SE. To install the WinFlash utility, run WINFLASH.EXE from the following directory:

UTILITY\WINFLASH 1.51

### PC-CILLIN 2002

The PC-CILLIN 2002 software program provides anti-virus protection for your system. This program is available for Windows 2000/ME/98SE/XP and Windows NT. Be sure to check the readme.txt and install the appropriate anti-virus software for your operating system.

We strongly recommend users to install this free anti-virus software to help protect your system against viruses.

### **MediaRing Talk – Telephony Software**

To install the MediaRing Talk voice modem software for the built-in modem, go to the directory \UTILITY\MEDIARING TALK, then run MRTALK-SETUP72.EXE to install the application software.

### **Super Voice – Fax/Modem Software**

To install the Super Voice voice, fax, data communication application for use with the built-in fax/modem, go the directory \UTILITY\SUPER\_VOICE, then run PICSHELL.EXE to install the application software.

### **CD Ghost**

The CD Ghost software enables you to create a virtual cabinet of CD-ROM drives on your system to help you categorize and organize your CD collection. A user-friendly interface assists you in quickly creating images of both CDs and DVDs onto your system. To install the software, run SETUP.EXE from the following directory:

\UTILITY\CDGHOST\ENG\CDGHOST

### **Recovery Genius**

The Recovery Genius software program is an innovative windows application system that protects your Hard Disk Drive from virus intrusion, accidental deletions and from system corruption. To install the Recovery Genius software program run SETUP.EXE from the following directory:

\UTILITY\RECOVERY GENIUS\ENG\RECOVERYGENIUS

### **Language Genius**

The Language Genius is a software –based product that helps you to learn new languages. To install the Language Genius software program run SETUP.EXE from the following directory:

\UTILITY\LANGUAGE GENIUS\ENGLANGUAGEGENIUS

### **PageABC**

The PageABC application software enables you to create your very own home page. To install the PageABC, go to the directory \UTILITYPageABC, and then run SETUP.EXE to install the application software.

This concludes Chapter 4.