

## FCC Compliance Statement:

<p style="text-align: center;"><b>DECLARATION OF CONFORMITY</b> Per FCC Part 2 Section 2.107(a)</p> <p style="text-align: center;"><b>FC</b></p> <p>Responsible Party Name: G.B.T. INC.</p> <p style="text-align: center;">Address: 18365 Valley Blvd., Suite#A LA Puente, CA 91744</p> <p style="text-align: center;">Phone/Fax No: (818) 854-9338 / (818) 854-9339</p> <p>hereby declares that the product</p> <p style="text-align: center;">Product Name: Mother Board</p> <p style="text-align: center;">Model Number: GA-7ZM/C</p> <p>Conforms to the following specifications:</p> <p style="text-align: center;">FCC Part 15, Subpart B, Section 15.107(a) and Section 15.109(a), Class B Digital Device.</p> <p><b>Supplementary Information:</b></p> <p style="text-align: center;">This device complies with part 15 of the FCC Rules. Operation is subject to the following two conditions: (1) This device may not cause harmful and (2) this device must accept any interference received, including that may cause undesired operation.</p> <p>Representative Person's Name: <u>ERIC LU</u></p> <p>Signature: <u>Eric Lu</u></p> <p>Date: <u>Jan 15, 2001</u></p>
--

This equipment has been tested and found to comply with limits for a Class B digital device, pursuant to Part 15 of the FCC rules. These limits are designed to provide reasonable protection against harmful interference in residential installations. This equipment generates, uses, and can radiate radio frequency energy, and if not installed and used in accordance with the instructions, may cause harmful interference to radio communications. However, there is no guarantee that interference will not occur in a particular installation. If this equipment does cause interference to radio or television equipment reception, which can be

determined by turning the equipment off and on, the user is encouraged to try to correct the interference by one or more of the following measures:

- Reorient or relocate the receiving antenna
- Move the equipment away from the receiver
- Plug the equipment into an outlet on a circuit different from that to which the receiver is connected
- Consult the dealer or an experienced radio/television technician for additional suggestions

You are cautioned that any change or modifications to the equipment not expressly approve by the party responsible for compliance could void Your authority to operate such equipment.

This device complies with Part 15 of the FCC Rules. Operation is subjected to the following two conditions 1) this device may not cause harmful interference and 2) this device must accept any interference received, including interference that may cause undesired operation.

# Declaration of Conformity

We, Manufacturer/Importer  
(full address)

**G.B.T. Technology Trading GmbH**  
**Ausschlagler Weg 41, 1F, 20537 Hamburg, Germany**

declare that the product  
(description of the apparatus, system, installation to which it refers)

**Mother Board**  
GA-7ZMMC

is in conformity with  
(reference to the specification under which conformity is declared)  
in accordance with 89/336 EEC-EMC Directive

- |   |  |  |   |
|---|--|--|---|
| <input type="checkbox"/> EN 55011   | Limits and methods of measurement of radio disturbance characteristics of industrial, scientific and medical (ISM high frequency equipment                 | <input type="checkbox"/> EN 61000-3-2*           | Disturbances in supply systems caused by household appliances and similar electrical equipment "Harmonics"            |
| <input type="checkbox"/> EN55013  | Limits and methods of measurement of radio disturbance characteristics of broadcast receivers and associated equipment                                     | <input checked="" type="checkbox"/> EN60555-2    |   |
| <input type="checkbox"/> EN 55014   | Limits and methods of measurement of radio disturbance characteristics of household electrical appliances, portable tools and similar electrical apparatus | <input checked="" type="checkbox"/> EN61000-3-3* | Disturbances in supply systems caused by household appliances and similar electrical equipment "Voltage fluctuations" |
| <input type="checkbox"/> EN 55015   | Limits and methods of measurement of radio disturbance characteristics of fluorescent lamps and luminaries   | <input checked="" type="checkbox"/> EN 50081-1   | Generic emission standard Part 1: Residual, commercial and light industry   |
| <input type="checkbox"/> EN 55020   | Immunity from radio interference of broadcast receivers and associated equipment   | <input checked="" type="checkbox"/> EN 50082-1   | Generic immunity standard Part 1: Residual, commercial and light industry   |
| <input checked="" type="checkbox"/> EN 55022  | Limits and methods of measurement of radio disturbance characteristics of information technology equipment   | <input type="checkbox"/> EN 55081-2              | Generic emission standard Part 2: Industrial environment  |
| <input type="checkbox"/> DIN VDE 0855<br><input type="checkbox"/> part 10<br><input type="checkbox"/> part 12 | Cabled distribution systems; Equipment for receiving and/or distribution from sound and television signals   | <input type="checkbox"/> EN 55082-2              | Generic immunity standard Part 2: Industrial environment  |
| <input checked="" type="checkbox"/> CE marking  |  | <input type="checkbox"/> ENV 55104               | Immunity requirements for household appliances tools and similar apparatus  |
|   |  | <input type="checkbox"/> EN 50091- 2             | EMC requirements for uninterruptible power systems (UPS)  |



(EC conformity marking)

**The manufacturer also declares the conformity of above mentioned product with the actual required safety standards in accordance with LVD 73/23 EEC**

- |                                   |   |                                     |   |
|-----------------------------------|---|-------------------------------------|---|
| <input type="checkbox"/> EN 60065 | Safety requirements for mains operated electronic and related apparatus for household and similar general use | <input type="checkbox"/> EN 60950   | Safety for information technology equipment including electrical business equipment |
| <input type="checkbox"/> EN 60335 | Safety of household and similar electrical appliances   | <input type="checkbox"/> EN 50091-1 | General and Safety requirements for uninterruptible power systems (UPS)             |

Manufacturer/Importer

Signature : Rex Lin  
Name : Rex Lin

(Stamp)

Date : Jan. 15, 2001

**7ZMMC**

**AMD Athlon™/Duron™ Socket A Processor  
Motherboard**

# **USER'S MANUAL**

AMD Athlon™/Duron™ Socket A Processor Motherboard  
REV. 2.01 Third Edition  
R-201-03-010627



## How This Manual Is Organized

This manual is divided into the following sections:

<b>1) Revision History</b>	Manual revision information
<b>2) Item Checklist</b>	Product item list
<b>3) Features</b>	Product information & specification
<b>4) Hardware Setup</b>	Instructions on setting up the motherboard
<b>5) Performance &amp; Block Diagram</b>	Product performance & block diagram
<b>6) Suspend to RAM</b>	Instructions STR installation
<b>7) Four Speaker &amp; SPDIF</b>	Four Speaker & SPDIF introduction
<b>8) @BIOS™ &amp; EasyTuneIII™</b>	@BIOS™ & EasyTuneIII™ introduction
<b>9) BIOS Setup</b>	Instructions on setting up the BIOS software
<b>10) Appendix</b>	General reference



## Table Of Content

Revision History	P.1
Item Checklist	P.2
Feature Summary	P.3
7ZMMC Motherboard Layout	P.5
Page Index for CPU Speed Setup / Connectors / Panel and Jumper Definition	P.6
Performance List	P.23
Block Diagram	P.25
Suspend to RAM Installation	P.26
Four Speaker & SPDIF Introduction (Optional)	P.32
@BIOS™ Introduction	P.38
EasyTuneIII™ Introduction	P.39
Memory Installation	P.41
Page Index for BIOS Setup	P.42
Appendix	P.67

## Revision History

Revision	Revision Note	Date
2.01	Initial release of the 7ZMMC motherboard user's manual.	Feb. 2001
2.01	Second release of the 7ZMMC motherboard user's manual.	Apr. 2001
2.01	Third release of the 7ZMMC motherboard user's manual.	Jun. 2001

The author assumes no responsibility for any errors or omissions that may appear in this document nor does the author make a commitment to update the information contained herein. Third-party brands and names are the property of their respective owners.



## Item Checklist

- The 7ZMMC motherboard
- Cable for IDE / floppy device
- Diskettes or CD (GA-7ZMM CD) for motherboard driver & utility
- 7ZMMC user's manual

## Feature Summary

Form Factor	<ul style="list-style-type: none"> <li>24.4 cm x 22.2 cm Micro ATX size form factor, 4 layers PCB.</li> </ul>
CPU	<ul style="list-style-type: none"> <li>AMD Athlon™/Duron™ (K7) Socket A Processor</li> <li>256K/64K L2 cache on die</li> <li>Supports 600MHz ~ 1GHz and above</li> </ul>
Chipset	Pro Savage KM133, consisting of: <ul style="list-style-type: none"> <li>VT8365 Memory/AGP/PCI Controller (PAC)</li> <li>VT82C686B PCI Super-I/O Integrated Peripheral Controller (PSIPC)</li> </ul>
Clock Generator	<ul style="list-style-type: none"> <li>ICS 9248BF-141 100/102*/104*/106*/108*/110*/112*/133 MHz system bus speeds (* These speed settings are not guaranteed)</li> </ul>
Memory	<ul style="list-style-type: none"> <li>2 168-pin DIMM sockets</li> <li>Supports PC-100/133 and VCM SDRAM</li> <li>Supports up to 1.0GB DRAM</li> <li>Supports only 3.3V SDRAM DIMM</li> </ul>
I/O Control	<ul style="list-style-type: none"> <li>VT82C686B</li> </ul>
Slots	<ul style="list-style-type: none"> <li>1 AGP slot supports 4X mode &amp; AGP 2.0 compliant</li> <li>3 PCI slots supports 33MHz &amp; PCI 2.2 compliant</li> <li>1 CNR (Communication and Networking Riser) slot (Not support LAN)</li> </ul>
On-Board IDE	<ul style="list-style-type: none"> <li>2 IDE bus master (UDMA 33/ATA 66/ATA 100) IDE ports for up to 4 ATAPI devices</li> <li>Supports PIO mode 3, 4 (UDMA 33/ATA 66/ATA 100) IDE &amp; ATAPI CD-ROM</li> </ul>
On-Board Peripherals	<ul style="list-style-type: none"> <li>1 floppy port supports 2 FDD with 360K, 720K, 1.2M, 1.44M and 2.88M bytes</li> <li>1 parallel port supports Normal/EPP/ECP mode</li> <li>1 serial port (COM A)</li> <li>4 USB ports</li> </ul>
Hardware Monitor	<ul style="list-style-type: none"> <li>CPU/System fan revolution detection</li> <li>CPU/Power/System fan control</li> <li>System voltage detection</li> <li>CPU/System temperature detection</li> </ul>

To be continued...

---

Features Summary

PS/2 Connector	<ul style="list-style-type: none"><li>• PS/2<sup>®</sup> Keyboard interface and PS/2<sup>®</sup> Mouse interface</li></ul>
On-Board VGA	<ul style="list-style-type: none"><li>• Build S3 Savage4 (86C370) in VT8365</li><li>• Support shared memory architecture</li></ul>
On-Board Sound	<ul style="list-style-type: none"><li>• Creative CT5880 sound (Optional)</li><li>• AC'97 CODEC</li><li>• Line In / Line Out / Mic In / AUX In / CD In / TEL / SPDIF (Optional) / Game Port / Four Speaker (Optional)</li></ul>
BIOS	<ul style="list-style-type: none"><li>• Licensed AMI BIOS, 2M bit flash ROM</li></ul>
Additional Features	<ul style="list-style-type: none"><li>• Support Wake-On-LAN (WOL)</li><li>• Support Internal / External Modem Ring On</li><li>• Support USB KB/MS Wake up from S3-S5</li><li>• Includes 3 fan power connectors</li><li>• Poly fuse for keyboard over-current protection</li><li>• Support STR (Suspend-To-RAM) function</li><li>• Support @BIOS<sup>™</sup> and EasyTuneIII<sup>™</sup></li></ul>

# 7ZMMC Motherboard Layout

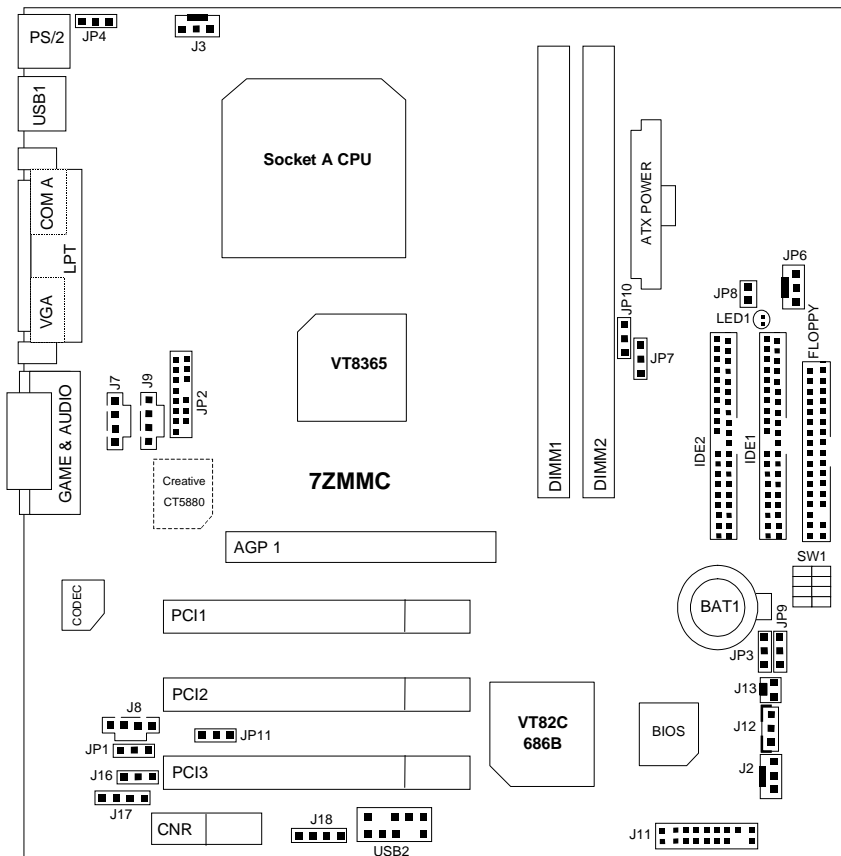

 Page Index for CPU Speed Setup/Connectors/Panel and Jumper Definition	Page
CPU Speed Setup	P.7
SW1	P.7
Connectors	P.8
ATX Power	P.8
COM A / VGA / LPT Port	P.8
Floppy Connector	P.9
Game & Audio Port	P.9
IDE 1(Primary) / IDE 2(Secondary) Connector	P.10
J2 (System Fan)	P.10
J3 (CPU Fan)	P.11
J7 (AUX_IN)	P.11
J8 (TEL)	P.12
J9 (CD Audio Line In)	P.12
J12 (Wake On LAN)	P.13
J13 (Ring Power On)	P.13
JP2 (Front Audio)	P.14
JP6 (Power Fan)	P.14
JP8 / LED1 (DIMM LED Connector & DIMM LED)	P.15
PS/2 Keyboard & PS/2 Mouse Port	P.15
USB1 (Rear USB Port)	P.16
USB2 (Front USB Connector)	P.16
Panel and Jumper Definition	P.17
BAT1 (Battery)	P.17
J11 (2x11 Pins Front Panel)	P.17
J16/J17/J18 (CNR Select) [Optional]	P.18
JP1 (Front MIC Function)	P.19
JP3 (Clear CMOS Function) [Optional]	P.19
JP4 (USB Device Wake up Selection)	P.20
JP7 (STR Function Enable)	P.20
JP9 (BIOS Write Protect Function)	P.21
JP10 (CPU Clock Frequency) [Optional]	P.21
JP11 (Onboard Sound Function Selection)	P.22

## CPU Speed Setup

The system bus speed is selectable at 100MHz. The user can select the system bus speed by DIP switch **SW1**.

SW1: CPU Speed Setup

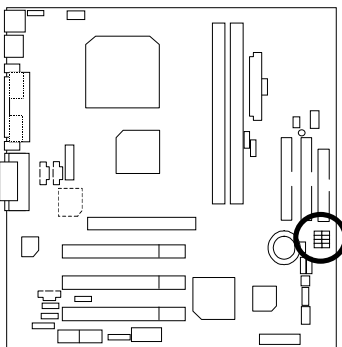

SW1:

O: ON, X: OFF

FSB	1	2	3	4
*95	O	O	X	O
100	X	O	X	X
*102	O	O	X	X
*103	X	O	X	O
*107	O	X	O	O
*110	O	X	O	X
*113	X	X	O	O
*115	X	X	X	O
*133	X	X	X	X

\* These speed settings are not guaranteed.

### AMD CPU Heat Sink Installation:

Beware: Please check that the heat sink is in good contact with the CPU before you turn on your system.

**The poor contact will cause over heat, and might cause damage to your processor.**

## Connectors

### ATX Power

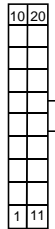
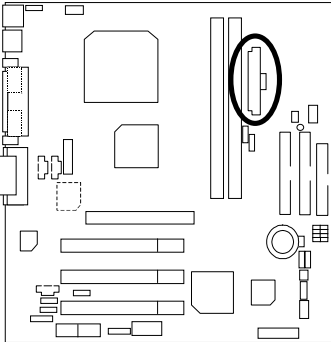

Pin No.	Definition
3,5,7,13, 15-17	GND
1,2,11	3.3V
4,6,19,20	VCC
10	+12V
12	-12V
18	-5V
8	Power Good
9	5V SB stand by+5V
14	PS-ON(Soft On/Off)

### COM A / VGA / LPT Port

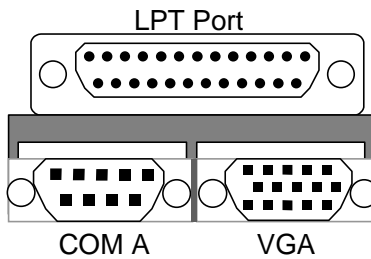
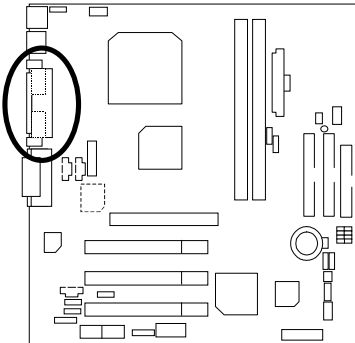

## Floppy Connector

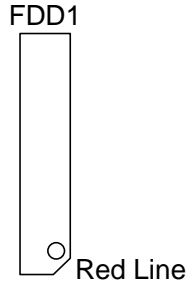
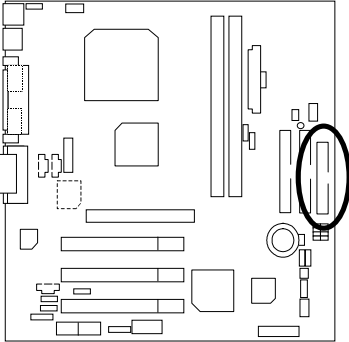

## Game & Audio Port

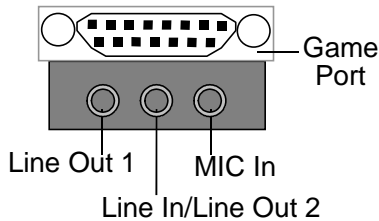
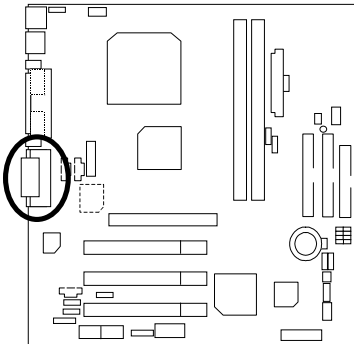

Line Out 1: Line Out or SPDIF (The SPDIF output is capable of providing digital audio to external speakers or compressed AC3 data to an external Dolby digital decoder). To enable SPDIF, simply insert SPDIF connector into Line Out1. Line Out1 will become SPDIF Out automatically. (see page 35 for more information).

To enable Four Speaker (for Creative 5880 audio only), simply follow instructions on page 32 and Line In will become Line Out2 to support second pair of stereo speakers.



## IDE1 (Primary), IDE2 (Secondary) Connector

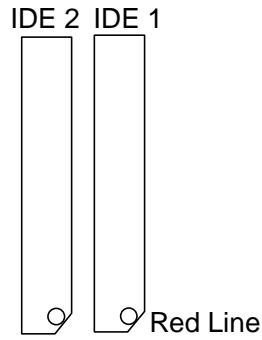
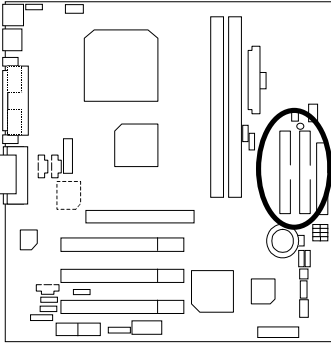

## J2: System Fan

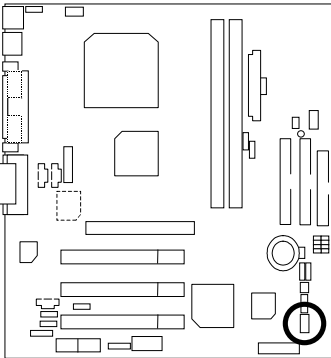

Pin No.	Definition
1	Control
2	+12V
3	SENSE

### J3: CPU Fan

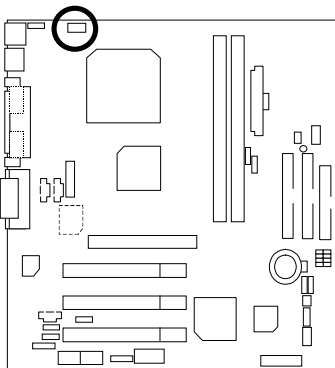

Pin No.	Definition
1	Control
2	+12V
3	SENSE

### J7: AUX\_IN

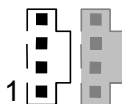
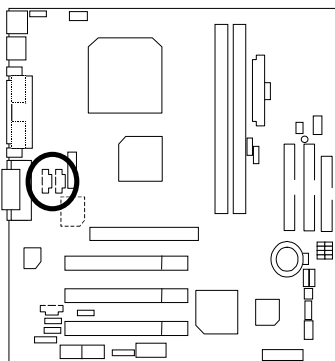

Pin No.	Definition
1	AUX-L
2	GND
3	GND
4	AUX-R

J8 TEL: The connector is for Modem with internal voice connector

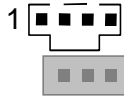
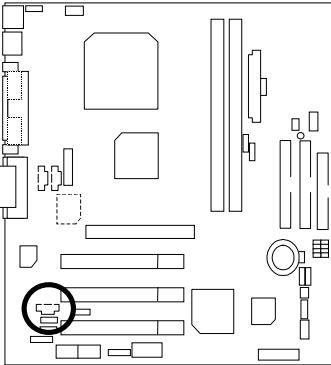

Pin No.	Definition
1	Signal-In
2	GND
3	GND
4	Signal-Out

J9: CD Audio Line In

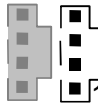
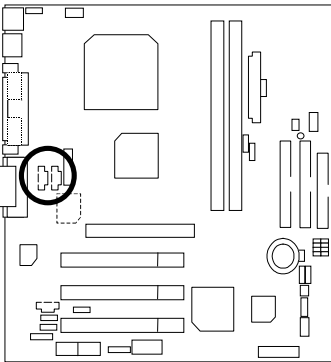

Pin No.	Definition
1	CD-L
2	GND
3	GND
4	CD-R

### J12: Wake On LAN

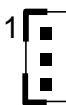
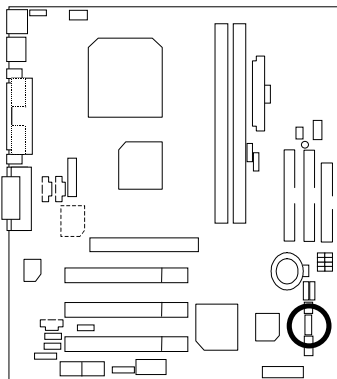

Pin No.	Definition
1	+5V SB
2	GND
3	Signal

### J13: Ring Power On (Internal Modem Card Wake Up)

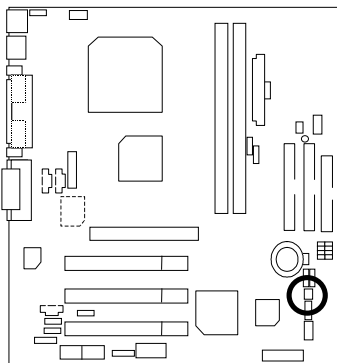

Pin No.	Definition
1	Signal
2	GND

## JP2: Front Audio

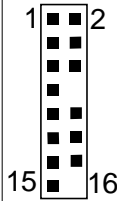
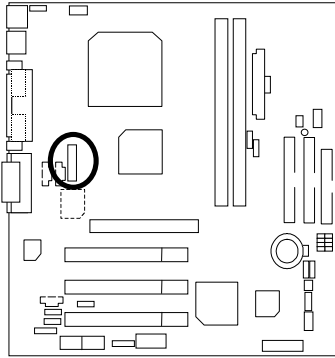

Pin No.	Definition
1	Incase speaker (R)
2	Incase speaker (L)
3,4,5,6, 10,15	GND
7	+12V
8,16	NC
9	MIC
11	Front Audio (R)
13	Front Audio (L)
12	Rear Audio (R)
14	Rear Audio (L)

## JP6: Power Fan

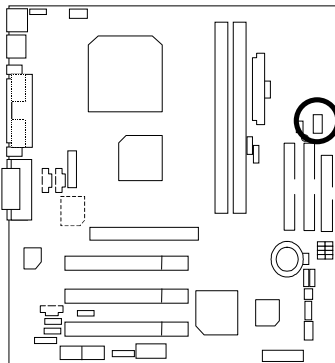

Pin No.	Definition
1	Control
2	+12V
3	NC

JP8 / LED1: STR LED Connector & DIMM LED

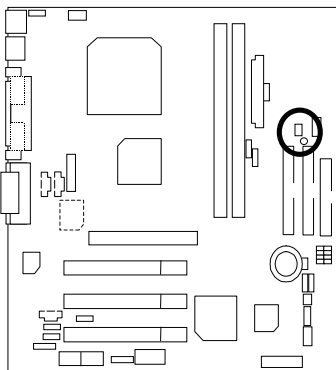

STR LED Connector External.



DIMM LED

PS/2 Keyboard & PS/2 Mouse Port

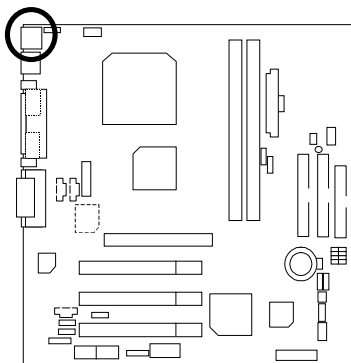

PS/2 Mouse

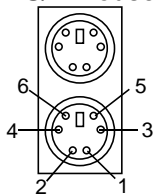

PS/2 Keyboard

PS/2 Mouse/Keyboard	
Pin No.	Definition
1	Data
2	NC
3	GND
4	VCC(+5V)
5	Clock
6	NC

## USB 1: Rear USB Port

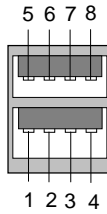
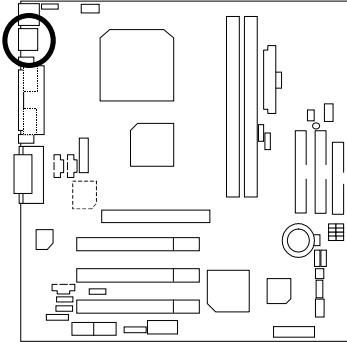

Pin No.	Definition
1	USB V0
2	USB D0-
3	USB D0+
4	GND
5	USB V1
6	USB D1-
7	USB D1+
8	GND

## USB 2: Front USB Connector

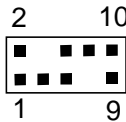
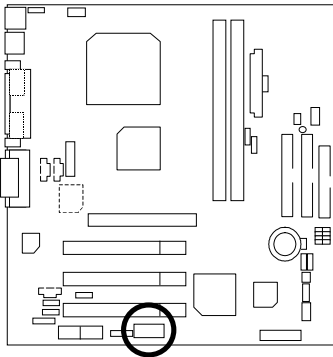

Pin No.	Definition
1	+5V
2	GND
3	USB D2-
4	NC
5	USB D2+
6	USB D3+
7	NC
8	USB D3-
9	GND
10	+5V

## Panel And Jumper Definition

### BAT1: Battery

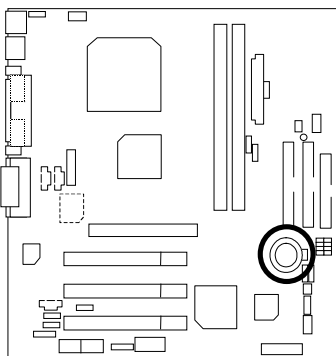

#### CAUTION

- ⚠ Danger of explosion if battery is incorrectly replaced.
- ⚠ Replace only with the same or equivalent type recommended by the manufacturer.
- ⚠ Dispose of used batteries according to the manufacturer's instructions.

### J11: 2x11 Pins Front Panel

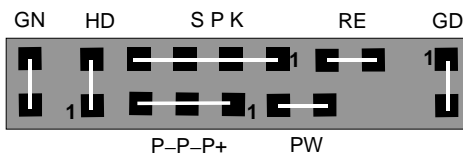
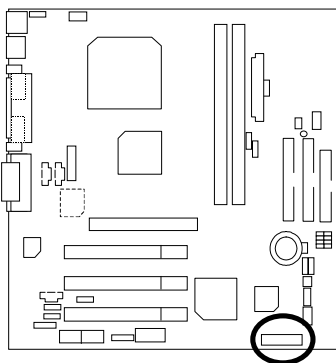



GN (Green Switch)	Open: Normal Operation Close: Entering Green Mode
GD (Green LED)	Pin 1: LED anode(+) Pin 2: LED cathode(-)
HD (IDE Hard Disk Active LED)	Pin 1: LED anode(+) Pin 2: LED cathode(-)
SPK (Speaker Connector)	Pin 1: VCC(+) Pin 2- Pin 3: NC Pin 4: Data(-)
RE (Reset Switch)	Open: Normal Operation Close: Reset Hardware System
P+P-P-(Power LED)	Pin 1: LED anode(+) Pin 2: LED cathode(-) Pin 3: LED cathode(-)
PW (Soft Power Connector)	Open: Normal Operation Close: Power On/Off

**J16 /J17/J18: CNR (Primary or Secondary) Select [Optional]  
(CNR→ Communication and Networking Riser)**

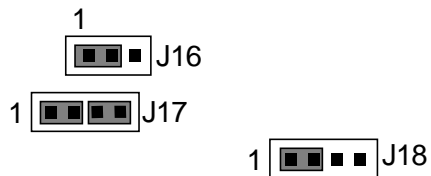
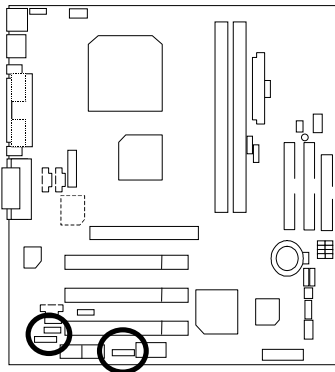

	J16	J17	J18
Onboard AC97	1-2	1-2	1-2
CNR (Primary)	2-3	3-4	3-4
Onboard AC97 CNR (Secondary) [Optional]	1-2	1-2 3-4	1-2

### JP1: Front MIC Function

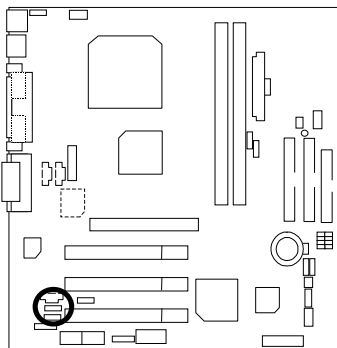

Pin No.	Definition
1-2 close	Enable Front MIC Function
2-3 close	Disable Front MIC Function

### JP3: Clear CMOS Function (Optional)

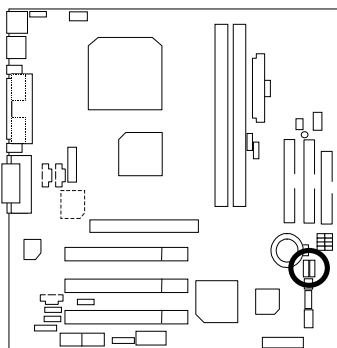

Pin No.	Definition
1-2 close	Normal (Default)
2-3 close	Clear CMOS

### JP4: USB Device Wake up Selection

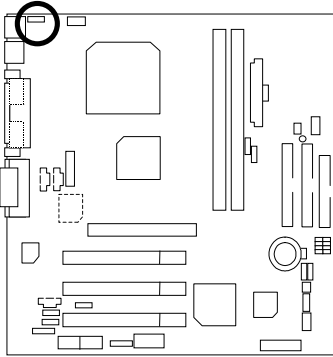

Pin No.	Definition
1-2 close	Normal (Default)
2-3 close	USB Device Wake up

(If you want to use “**USB Dev Wakeup from S3~S5**” function, you have to set the BIOS setting “USB Dev Wakeup from S3~S5” enabled, and the jumper “**JP4**” enabled)

\*(Power on the computer and as soon as memory counting starts, press <Del>. You will enter BIOS Setup. Select the item “**POWER MANAGEMENT SETUP**”, then select “**USB Dev Wakeup from S3~S5**”. Remember to save the setting by pressing “ESC” and choose the “**SAVE & EXIT SETUP**” option.)

### JP7: STR Function Enable

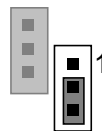
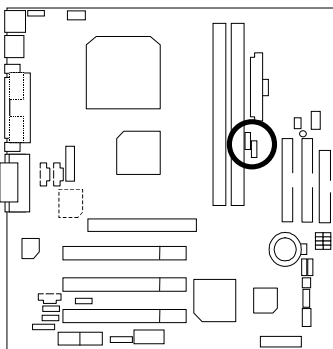

Pin No.	Definition
1-2 close	STR Enable
2-3 close	Normal (Default)

## JP9: BIOS Write Protect Function

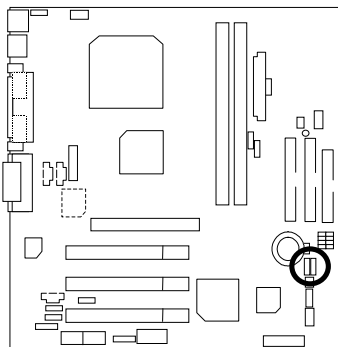

Pin No.	Definition
1-2 close	Write Protect Enable
2-3 close	Write Protect Disable (Default)

● Please set Jumper JP9 to “2-3 close” to enabled BIOS write function when you update new BIOS or new device.

## JP10: CPU Clock Frequency (Optional)

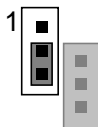
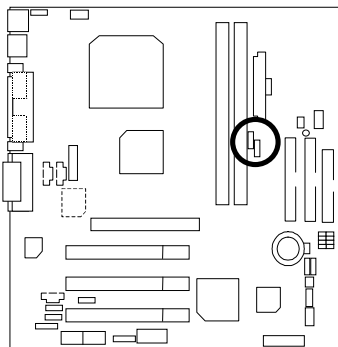

Pin No.	Definition
1-2 close	133MHz
2-3 close	100MHz (Default)

## JP11: Onboard Sound Function Selection

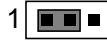
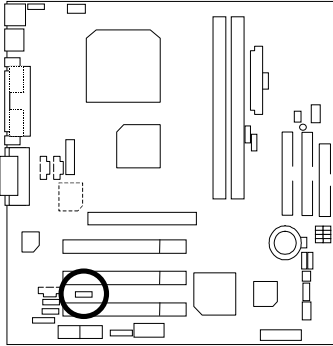

Pin No.	Definition
1-2 close	Onboard Sound Enable (Default)
2-3 close	Onboard Sound Disable

## Performance List

The following performance data list is the testing results of some popular benchmark testing programs.

These data are just referred by users, and there is no responsibility for different testing data values gotten by users. (The different Hardware & Software configuration will result in different benchmark testing results.)

- CPU AMD K7 Athlon™ 1100MHz processor
- DRAM (128x2) MB SDRAM (MICRON MT48LC8M8A2-8E B)
- CACHE SIZE 384KB included in CPU
- DISPLAY Gigabyte GF2000
- STORAGE Onboard IDE (IBM DTLA-307045)
- O.S. Windows NT™ 4.0 SP6a
- DRIVER Display Driver at 1024 x 768 x 16bit colors x 75Hz.

Processor	AMD Athlon™ 1100MHz (100x11)
<b>Winbench99</b>	
CPU mark 99	99.6
FPU Winmark 99	6040
Business Disk Winmark 99	8600
Hi-End Disk Winmark 99	20900
Business Graphics Winmark 99	551
Hi-End Graphics Winmark 99	1100
<b>Winstone99</b>	
Business Winstone 99	52.6
Hi-End Winstone 99	66.4

- CPU AMD K7 Athlon™ 1100MHz processor
- DRAM (128x2) MB SDRAM (KINGMAX KSV884T4A1A)
- CACHE SIZE 384KB included in CPU
- DISPLAY VIA OnChip Display
- STORAGE Onboard IDE (IBM DTLA-307045)
- O.S. Windows NT™ 4.0 SP6a
- DRIVER Display Driver at 1024 x 768 x 16bit colors x 75Hz.

Processor	AMD Athlon™ 1100MHz (100x11)
<b>Winbench99</b>	
CPU mark 99	94.3
FPU Winmark 99	6050
Business Disk Winmark 99	9100
Hi-End Disk Winmark 99	22600
Business Graphics Winmark 99	241
Hi-End Graphics Winmark 99	738
<b>Winstone99</b>	
Business Winstone 99	46.5
Hi-End Winstone 99	61.7

# Block Diagram

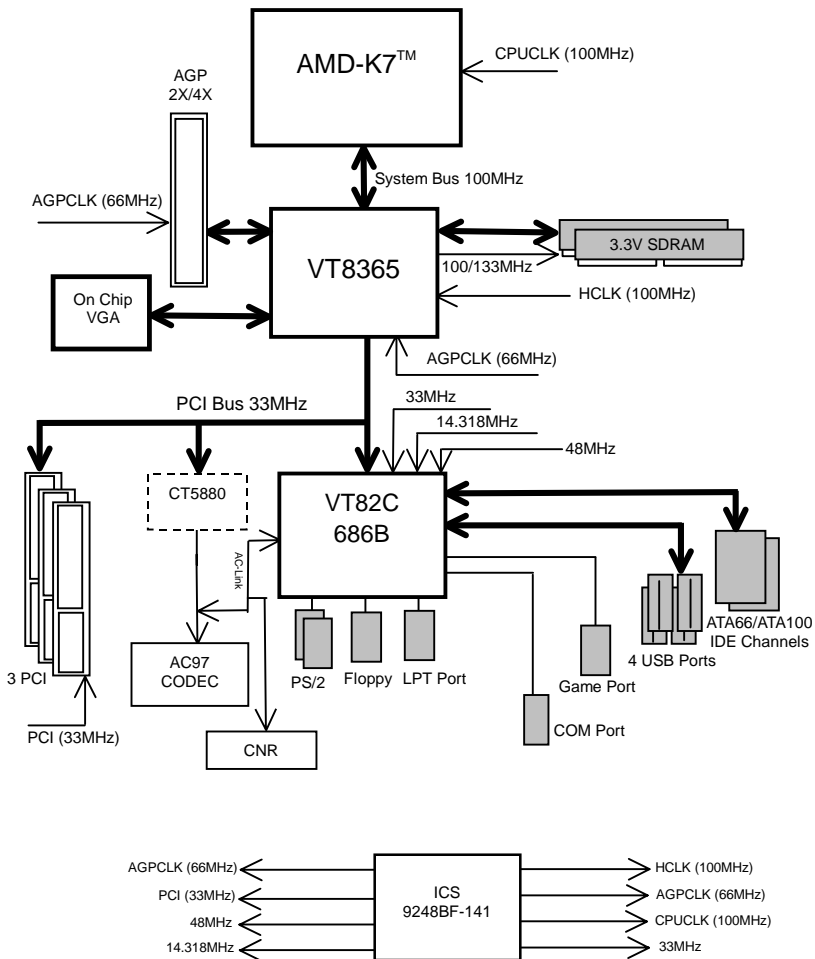



---

## Suspend To RAM Installation

### A.1 Introduce STR function:

Suspend-to-RAM (STR) is a Windows 98 ACPI sleep mode function. When recovering from STR (S3) sleep mode, the system is able, in just a few seconds, to retrieve the last “state” of the system before it went to sleep and recover to that state. The “state” is stored in memory (RAM) before the system goes to sleep. During STR sleep mode, your system uses only enough energy to maintain critical information and system functions, primarily the system state and the ability to recognize various “wake up” triggers or signals, respectively.

### A.2 STR function Installation

Please use the following steps to complete the STR function installation.

#### Step-By-Step Setup

##### Step 1:

To utilize the STR function, the system must be in Windows 98 ACPI mode.

Putting Windows 98 into ACPI mode is fairly easy.

#### Setup with Windows 98 CD:

- A. Insert the Windows 98 CD into your CD-ROM drive, select Start, and then Run.
- B. Type (without quotes) “**D:\setup**” in the window provided. Hit the enter key or click OK.
- C. After setup completes, remove the CD, and reboot your system  
(This manual assumes that your CD-ROM device drive letter is D:).

**Step 2:**

(If you want to use STR Function, please set jumper JP7 Closed.)

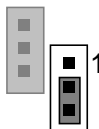
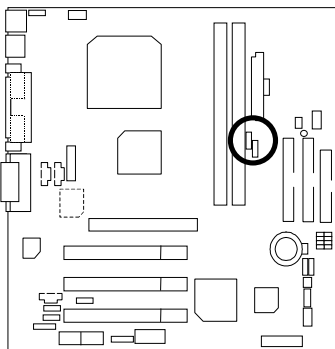

Pin No.	Definition
1-2 close	STR Enable
2-3 close	Normal (Default)

**Step 3:**

Power on the computer and as soon as memory counting starts, press <Del>. You will enter BIOS Setup. Select the item "**POWER MANAGEMENT SETUP**", then select "**ACPI Standby State: S3 / STR**". Remember to save the settings by pressing "ESC" and choose the "**SAVE & EXIT SETUP**" option.

Congratulation! You have completed the installation and now can use the STR function.

### A.3 How to put your system into STR mode?

There are two ways to accomplish this:

1. Choose the "Stand by" item in the "Shut Down Windows" area.
  - A. Press the "Start" button and then select "Shut Down"



- B. Choose the "Stand by" item and press "OK"

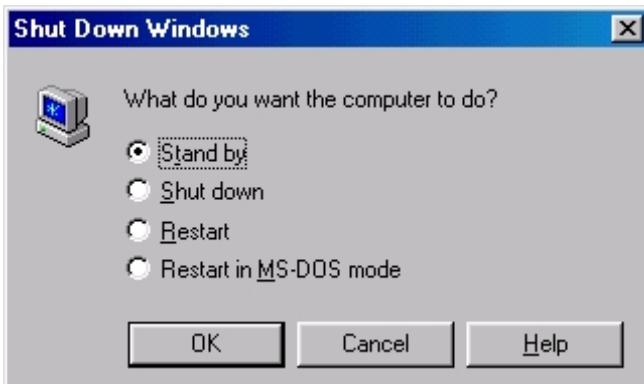

## 7ZMMC Motherboard

---

2. Define the system "power on" button to initiate STR sleep mode:
  - A. Double click "My Computer" and then "Control Panel"

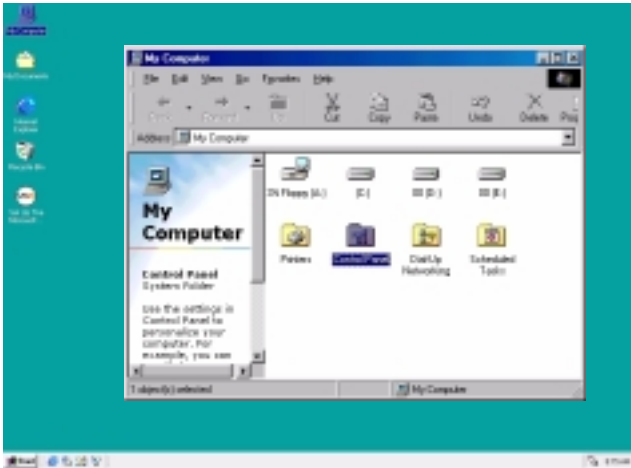

- B. Double click the " Power Management" item.

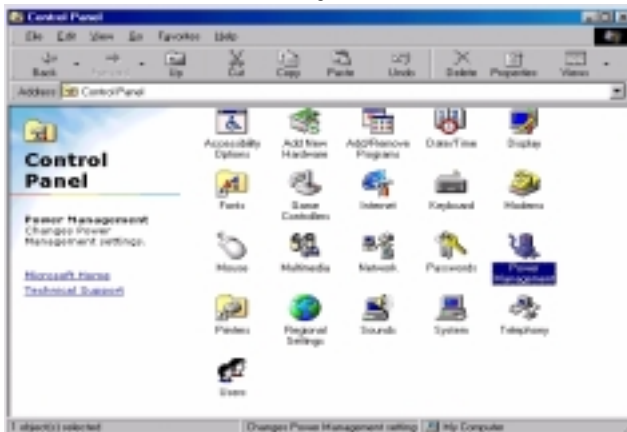

C. Select the "Advanced" tab and "Standby" mode in Power Buttons.



D. Restart your computer to complete setup.

Now when you want to enter STR sleep mode, just momentarily press the "Power on" button.

#### **A.4 How to recover from the STR sleep mode?**

There are five ways to "wake up" the system:

1. Press the "Power On" button.
2. Use the "Resume by Alarm" function.
3. Use the "Modem Ring On" function.
4. Use the "Wake On LAN" function.
5. Use the "USB Device Wake up" function

### A.5 Notices:

1. In order for STR to function properly, several hardware and software requirements must be satisfied:
  - A. Your ATX power supply must comply with the ATX 2.01 specification (provide more than 720 mA 5V Stand-By current).
  - B. Your SDRAM must be PC-100 compliant.
2. Jumper JP8 is provided to connect to the STR LED in your system chassis. [Your chassis may not provide this feature.] The STR LED will be illuminated when your system is in STR sleep mode.

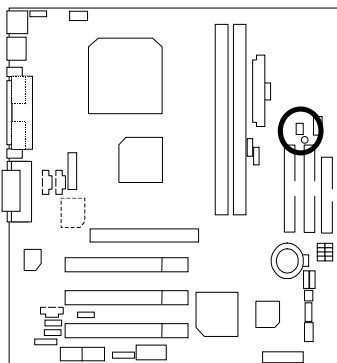

STR LED Connector External.



DIMM LED

## Four Speaker & SPDIF Introduction (Optional)

### Four Speaker Introduction

#### A. What is Four Speaker?

The Creative CT5880 audio chip can support up to 4 speaker output. If you select “Four speaker out”, Line In will be reconfigured as another line out to support a second pair of speakers.

#### B. How to use Four Speaker?

Microsoft Windows 98 Second Edition setup procedure:

- a. Click the audio icon along the task bar and select “Configure 3D Audio”

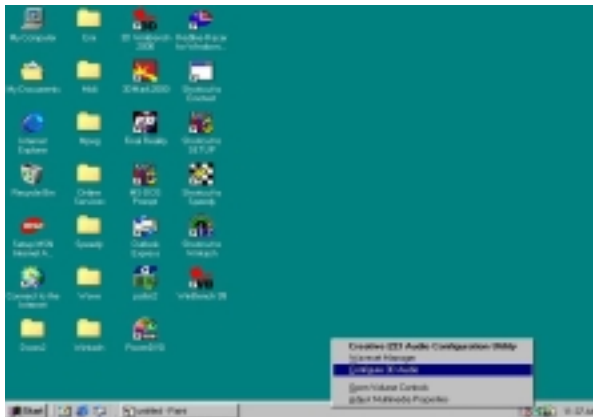

- b. Select two speaker (Default)

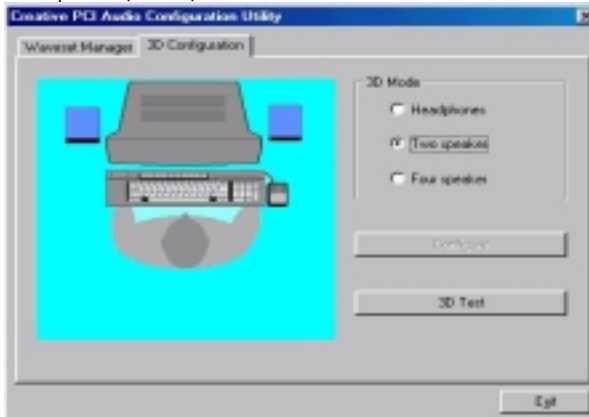

## 7ZMMC Motherboard

---

c. Select "Four speaker" item.



Microsoft Windows Me setup procedure:

a. Go to "Control Panel"

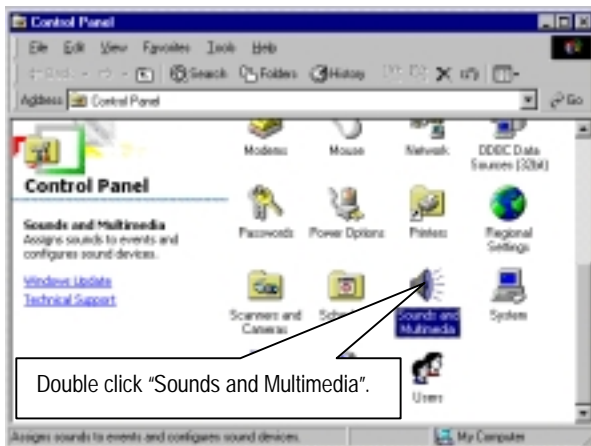



b. Select "Audio" Page, and click "Advanced" button.

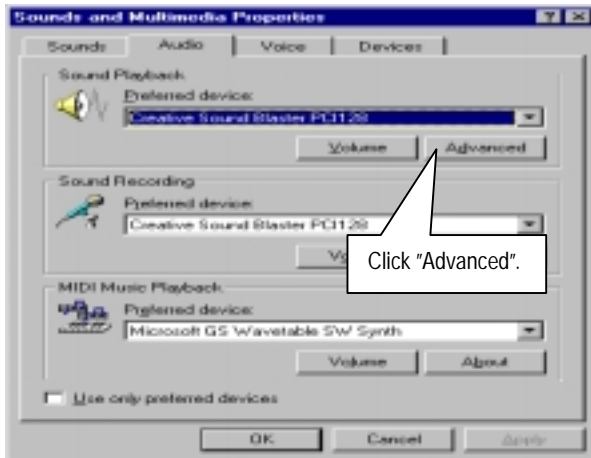

c. Select "Quadraphonic Speakers" and click ok.

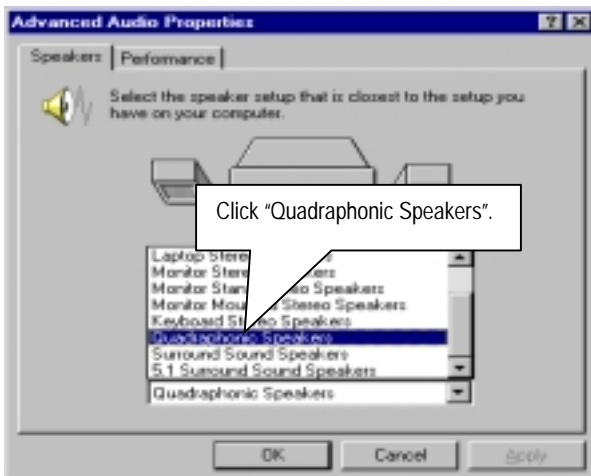

### C. Four Speaker Application

The four speaker function will only be supported in application softwares that use Microsoft DirectX and Creative EAX, for example, the game titles, software DVD player and MP3 player.

## SPDIF Introduction

### A. What is SPDIF?

The SPDIF output is capable of providing digital audio to external speakers or compressed AC3 data to an external Dolby digital decoder.

### B. How to use SPDIF?

- a. Click your mouse right button in "My Computer" and select the "Properties" item.

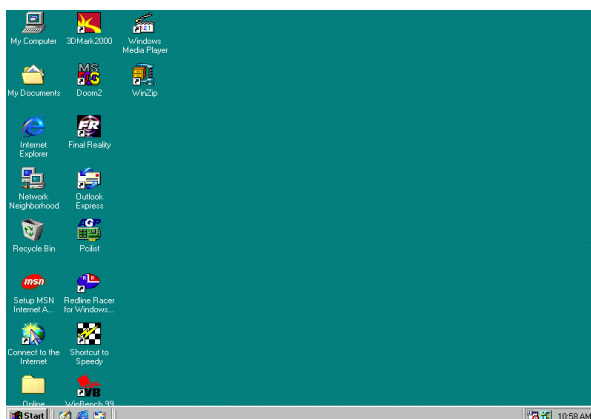

- b. Click "Device Manager" item.

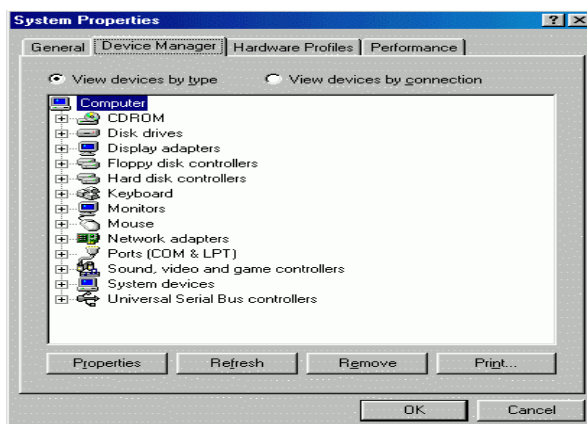

- c. Click “Sound, video and game controllers” item and select the “Creative Sound Blaster PCI128” item.

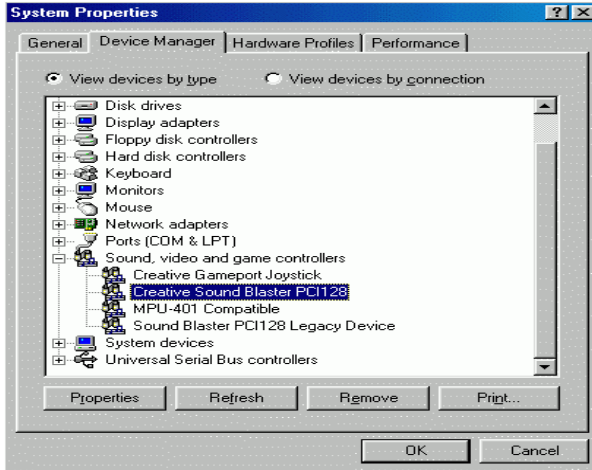

- d. Click “Settings” item and select the “Output Mode” item.

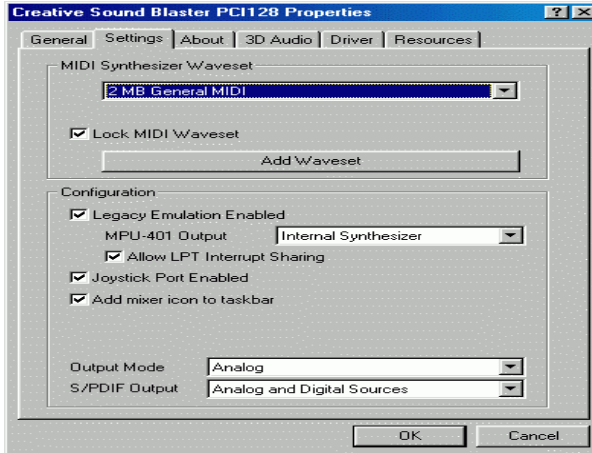

e. Click "Digital" item, Line Out will be reconfigure to SPDIF Out.

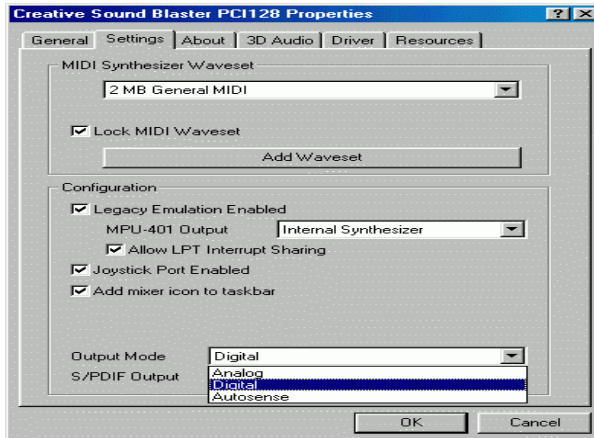

f. Recommend you to select "Autosense", It will automatically detect the type (mono or stereo) of the audio connector that you plug into Line Out audio jack, then configure Line Out to either SPDIF or Speaker accordingly.

## @BIOS™ Introduction

### Gigabyte announces @BIOS™ Windows BIOS live update utility



Have you ever updated BIOS by yourself? Or like many other people, you just know what BIOS is, but always hesitate to update it? Because you think updating newest BIOS is unnecessary and actually you don't know how to update it.

Maybe not like others, you are very experienced in BIOS updating and spend quite a lot of time to do it. But of course you don't like to do it too much. First, download different BIOS from website and then switch the operating system to DOS mode. Secondly, use different flash utility to update BIOS. The above process is not a interesting job. Besides, always be carefully to store the BIOS source code correctly in your disks as if you update the wrong BIOS, it will be a nightmare.

Certainly, you wonder why motherboard vendors could not just do something right to save your time and effort and save you from the lousy BIOS updating work? Here it comes! Now Gigabyte announces @BIOS™ --the first Windows BIOS live update utility. This is a smart BIOS update software. It could help you to download the BIOS from internet and update it. Not like the other BIOS update software, it's a Windows utility. With the help of "@BIOS™", BIOS updating is no more than a click.

Besides, no matter which mainboard you are using, if it's a Gigabyte's product\*, @BIOS™ help you to maintain the BIOS. This utility could detect your correct mainboard model and help you to choose the BIOS accordingly. It then downloads the BIOS from the nearest Gigabyte ftp site automatically. There are several different choices; you could use "Internet Update" to download and update your BIOS directly. Or you may want to keep a backup for your current BIOS, just choose "Save Current BIOS" to save it first. You make a wise choice to use Gigabyte, and @BIOS™ update your BIOS smartly. You are now worry free from updating wrong BIOS, and capable to maintain and manage your BIOS easily. Again, Gigabyte's innovative product erects a milestone in mainboard industries.

For such a wonderful software, how much it costs? Impossible! It's free! Now, if you buy a Gigabyte's motherboard, you could find this amazing software in the attached driver CD. But please remember, connected to internet at first, then you could have a internet BIOS update from your Gigabyte @BIOS™.

## EasyTuneIII™ Introduction

### Gigabyte announces EasyTuneIII™ Windows overdrive utility



“Overdrive” might be one of the most common issues in computer field. But have many users ever tried it? The answer is probably “no”. Because “overdrive” is thought to be very difficult and includes a lot of technical know-how, sometimes “overdrive” is even considered as special skills found only in some enthusiasts.

But as to the experts in “overdrive”, what’s the truth? They may spend quite a lot of time and money to study, try and use many different hardware and software tools to do “overdrive”. And even with these technologies, they still learn that it’s quite a risk because the safety and stability of an “overdrive” system is unknown.

Now everything is different because of a Windows overdrive utility EasyTuneIII™ --announced by Gigabyte. This utility has totally changed the gaming rule of “overdrive”. This is the first overdrive utility suitable for both normal and power users. Users can choose either “Easy Mode” or “Advanced Mode” to run “overdrive” at their convenience. For users who choose “Easy Mode”, they just need to click “Auto Optimize” to have auto and immediate CPU overclocking. This software will then overdrive CPU speed automatically with the result being shown in the control panel. If someone prefers to “overdrive” by oneself, there is also another choice. Click “Advanced Mode” to enjoy “sport drive” class overclocking. In “Advanced Mode”, one can change the system bus speed in small increments to get ultimate system performance. And no matter which mainboard is used, if it’s a Gigabyte’s product\*, EasyTuneIII™ helps to perform the best of system.

Besides, different from other traditional over-clocking methods, EasyTuneIII™ doesn’t require users to change neither BIOS nor hardware switch/ jumper setting; on the other hand, they can do “overdrive” at only one click. Therefore, this is a safer way for “overdrive” as nothing is changed on software or hardware. If user runs EasyTuneIII™ over system’s limitation, the biggest lost is only to restart the computer again and the side effect is then well controlled. Moreover, if one well-performed system speed been tested in EasyTuneIII™, user can “Save” this bus speed and “Load” it in next time. Obviously, Gigabyte EasyTuneIII™ has already turned the “overdrive” technology toward to a newer generation.

This wonderful software is now free bundled in Gigabyte motherboard attached driver CD. Users may make a test drive of "EasyTuneIII™" to find out more amazing features by themselves.

For further technical information, please link to: <http://www.gigabyte.com.tw>

**※ Note: If your CD version is 1.6 or below, please visit our website and download the latest EasyTuneIII™ version.**

## Memory Installation

The motherboard has 2 dual inline memory module (DIMM) sockets. The BIOS will automatically detects memory type and size. To install the memory module, just push it vertically into the DIMM Slot .The DIMM module can only fit in one direction due to the two notch. Memory size can vary between sockets.

Install memory in any combination table:

DIMM	168-pin SDRAM DIMM Modules	
DIMM 1	Supports 16 / 32 / 64 / 128 / 256 / 512 MB	X 1 pcs
DIMM 2	Supports 16 / 32 / 64 / 128 / 256 / 512 MB	X 1 pcs

★Total System Memory (Max 1.0GB)



 Page Index for BIOS Setup	Page
The Main Menu	P.44
Standard CMOS Setup	P.46
BIOS Features Setup	P.49
Chipset Features Setup	P.51
Power Management Setup	P.53
PNP/ PCI Configuration	P.56
Load BIOS Defaults	P.57
Load Setup Defaults	P.58
Integrated Peripherals	P.59
Hardware Monitor	P.62
Supervisor Password / User Password	P.63
IDE HDD Auto Detection	P.64
Save & Exit Setup	P.65
Exit Without Saving	P.66

## BIOS Setup

BIOS Setup is an overview of the BIOS Setup Program. The program that allows users to modify the basic system configuration. This type of information is stored in battery-backed CMOS RAM so that it retains the Setup information when the power is turned off.

### ENTERING SETUP

Power ON the computer and press <Del> immediately will allow you to enter Setup. If the message disappears before you respond and you still wish to enter Setup, restart the system to try again by turning it OFF then ON or pressing the "RESET" bottom on the system case. You may also restart by simultaneously press <Ctrl> – <Alt>– <Del> keys.

### CONTROL KEYS

<↑>	Move to previous item
<↓>	Move to next item
<<←>	Move to the item in the left hand
<→>	Move to the item in the right hand
<Esc>	Main Menu - Quit and not save changes into CMOS Status Page Setup Menu and Option Page Setup Menu - Exit current page and return to Main Menu
<+/PgUp>	Increase the numeric value or make changes
<-/PgDn>	Decrease the numeric value or make changes
<F1>	General help, only for Status Page Setup Menu and Option Page Setup Menu
<F2>	Reserved
<F3>	Reserved
<F4>	Reserved
<F5>	Restore the previous CMOS value from CMOS, only for Option Page Setup Menu
<F6>	Load the default CMOS value from BIOS default table, only for Option Page Setup Menu
<F7>	Load the Setup Defaults
<F8>	Reserved
<F9>	Reserved
<F10>	Save all the CMOS changes, only for Main Menu

## GETTING HELP

### Main Menu

The on-line description of the highlighted setup function is displayed at the bottom of the screen.

### Status Page Setup Menu / Option Page Setup Menu

Press F1 to pop up a small help window that describes the appropriate keys to use and the possible selections for the highlighted item. To exit the Help Window press <Esc>.

## The Main Menu

Once you enter AMI BIOS CMOS Setup Utility, the Main Menu (Figure 1) will appear on the screen. The Main Menu allows you to select from nine setup functions and two exit choices. Use arrow keys to select among the items and press <Enter> to accept or enter the sub-menu.

AMBIOS SIMPLE SETUP UTILITY-VERSION 1.24a ( C ) 1999 American Megatrends, Inc. All Rights Reserved	
STANDARD CMOS SETUP	INTEGRATED PERIPHERALS
BIOS FEATURES SETUP	HARDWARE MONITOR SETUP
CHIPSET FEATURES SETUP	SUPERVISOR PASSWORD
POWER MANAGEMENT SETUP	USER PASSWORD
PNP/PCI CONFIGURATION	IDE HDD AUTO DETECTION
LOAD BIOS DEFAULTS	SAVE & EXIT SETUP
LOAD SETUP DEFAULTS	EXIT WITHOUT SAVING
ESC : Quit    ↑↓←→ : Select Item    (Shift) F2 : Change Color    F5 : Old Values F6 : Load BIOS Defaults    F7 : Load Setup Defaults    F10: Save & Exit	
Time, Date, Hard Disk Type, ...	

Figure 1: Main Menu

- **Standard CMOS Setup**

This setup page includes all the items in standard compatible BIOS.

- **BIOS Features Setup**

This setup page includes all the items of AMI special enhanced features.

- **Chipset Features Setup**

This setup page includes all the items of chipset special features.

- **Power Management Setup**

This setup page includes all the items of Green function features.

- **PnP/PCI Configurations**

This setup page includes all the configurations of PCI & PnP ISA resources.

- **Load BIOS Defaults**

Bios Defaults indicates the value of the system parameter which the system would be in the safe configuration.

- **Load Setup Defaults**

Setup Defaults indicates the value of the system parameter which the system would be in the most appropriate configuration.

- **Integrated Peripherals**

This setup page includes all onboard peripherals.

- **Hardware Monitor Setup**

This setup page is auto detect fan and temperature status.

- **Supervisor password**

Change, set, or disable password. It allows you to limit access to the system and Setup, or just to Setup.

- **User password**

Change, set, or disable password. It allows you to limit access to the system.

- **IDE HDD auto detection**

Automatically configure hard disk parameters.

- **Save & Exit Setup**

Save CMOS value settings to CMOS and exit setup.

- **Exit Without Saving**

Abandon all CMOS value changes and exit setup.

## Standard CMOS Setup

The items in Standard CMOS Features Menu (Figure 2) are divided into 9 categories. Each category includes no, one or more than one setup items. Use the arrows to highlight the item and then use the <PgUp> or <PgDn> keys to select the value you want in each item.

AMIBIOS SETUP – STANDARD CMOS SETUP ( C ) 1999 American Megatrends, Inc. All Rights Reserved	
Date (mm/dd/yyyy) : Tue Jan 25, 2000 Time (hh/mm/ss) : 10:36:24	
TYPE	SIZE CYLS HEAD PRECOMP LANDZ SECTOR MODE
Pri Master : Auto	
Pri Slave : Auto	
Sec Master : Auto	
Sec Slave : Auto	
Floppy Drive A: 1.44 MB 3 ½	Base Memory : 640 Kb
Floppy Drive B: Not Installed	Other Memory: 384 Kb
	Extended Memory: 30Mb
Boot Sector Virus Protection : Disabled	Total Memory: 31Mb
Month: Jan – Dec	ESC : Exit
Day: 01 – 31	↑↓ : Select Item
Year: 1990– 2099	PU/PD/+/- : Modify
	(Shift)F2 : Color

Figure 2: Standard CMOS Setup

- **Date**

The date format is <Week> <Month> <Day>, <Year>.

Week	The week, from Sun to Sat, determined by the BIOS and is display-only
Month	The month, Jan. Through Dec.
Day	The day, from 1 to 31 (or the maximum allowed in the month)
Year	The year, from 1990 through 2099

- **Time**

The times format in <hour> <minute> <second>. The time is calculated base on the 24-hour military-time clock. For example, 1 p.m. is 13:00:00.

- **Primary Master, Slave / Secondary Master, Slave**

The category identifies the types of hard disk from drive C to F that has been installed in the computer. There are two types: auto type, and user definable type. User type is user-definable; Auto type which will automatically detect HDD type.

Note that the specifications of your drive must match with the drive table. The hard disk will not work properly if you enter improper information for this category.

If you select User Type, related information will be asked to enter to the following items. Enter the information directly from the keyboard and press <Enter>. Such information should be provided in the documentation form your hard disk vendor or the system manufacturer.

CYLS.	Number of cylinders
HEADS	number of heads
PRECOMP	write precomp
LANDZONE	Landing zone
SECTORS	number of sectors

If a hard disk has not been installed select NONE and press <Enter>.

- **Floppy Drive A / Drive B**

The category identifies the types of floppy disk drive A or drive B that has been installed in the computer.

None	No floppy drive installed
360K, 5.25 in.	5.25 inch PC-type standard drive; 360K byte capacity.
1.2M, 5.25 in.	5.25 inch AT-type high-density drive; 1.2M byte capacity (3.5 inch when 3 Mode is Enabled).
720K, 3.5 in.	3.5 inch double-sided drive; 720K byte capacity
1.44M, 3.5 in.	3.5 inch double-sided drive; 1.44M byte capacity.
2.88M, 3.5 in.	3.5 inch double-sided drive; 2.88M byte capacity.

● **Boot Sector Virus Protection**

If it is set to enable, the category will flash on the screen when there is any attempt to write to the boot sector or partition table of the hard disk drive. The system will halt and the following error message will appear in the mean time. You can run anti-virus program to locate the problem.

Enabled	Activate automatically when the system boots up causing a warning message to appear when anything attempts to access the boot sector or hard disk partition table
Disabled	No warning message to appear when anything attempts to access the boot sector or hard disk partition table. <b>(Default Value)</b>

● **Memory**

The category is display-only which is determined by POST (Power On Self Test) of the BIOS.

**Base Memory**

The POST of the BIOS will determine the amount of base (or conventional) memory installed in the system.

The value of the base memory is typically 512 K for systems with 512 K memory installed on the motherboard, or 640 K for systems with 640 K or more memory installed on the motherboard.

**Extended Memory**

The BIOS determines how much extended memory is present during the POST.

This is the amount of memory located above 1 MB in the CPU's memory address map.

**Other Memory**

This refers to the memory located in the 640 K to 1024 K address space. This is memory that can be used for different applications.

DOS uses this area to load device drivers to keep as much base memory free for application programs. Most use for this area is Shadow RAM

## BIOS Features Setup

AMIBIOS SETUP – BIOS FEATURES SETUP	
( C ) 1999 American Megatrends, Inc. All Rights Reserved	
1st Boot Device	Floppy
2nd Boot Device	IDE-0
3rd Boot Device	CDROM
S.M.A.R.T. for Hard Disks	Disabled
BootUp Num-Lock	On
Floppy Drive Seek	Disabled
Password Check	Setup
ESC : Quit                      ↑↓→← : Select Item F1 : Help                        PU/PD+/- : Modify F5 :Old Values                (Shift)F2:Color F6 : Load BIOS Defaults F7 : Load SETUP Defaults	

Figure 3: BIOS Features Setup

- 1st / 2nd / 3rd Boot Device**

Floppy	Boot Device by Floppy.
ZIP A: / LS120	Boot Device by ZIP A: / LS120.
CDROM	Boot Device by CDROM.
SCSI	Boot Device by SCSI.
NETWORK	Boot Device by NETWORK.
USB FDD	Boot Device by USB FDD.
IDE-0~IDE-3	Boot Device by IDE-0~IDE-3.
Disabled	Boot Device by Disabled.
ATAPI ZIP C:	Boot Device by ATAPI ZIP C:.

- S.M.A.R.T. for Hard Disks**

Enabled	Enable S.M.A.R.T. Hard for Disks.
Disabled	Disable S.M.A.R.T. Hard for Disks. <b>(Default Value)</b>



---

- **Boot Up Num-Lock**

On	Keypad is number keys. <b>(Default Value)</b>
Off	Keypad is arrow keys.

- **Floppy Drive Seek**

During POST, BIOS will determine if the floppy disk drive installed is 40 or 80 tracks. 360 type is 40 tracks while 720, 1.2 and 1.44 are all 80 tracks.

Enabled	BIOS searches for floppy disk drive to determine if it is 40 or 80 tracks. Note that BIOS can not tell from 720, 1.2 or 1.44 drive type as they are all 80 tracks.
Disabled	BIOS will not search for the type of floppy disk drive by track number. Note that there will not be any warning message if the drive installed is 360. <b>(Default Value)</b>

- **Password Check**

Setup	Set Password Check to Setup. <b>(Default Value)</b>
Always	Set Password Check to Always.

## Chipset Features Setup

AMIBIOS SETUP – CHIPSET FEATURES SETUP	
( C ) 1999 American Megatrends, Inc. All Rights Reserved	
Configure Timing by SPD	Disabled
DRAM Frequency	100MHz
SDRAM CAS# Latency	3
AGP Mode	4X
AGP Comp. Driving	Auto
Manual AGP Comp. Driving	CB
AGP Fast Write	Disabled
AGP Aperture Size	64MB
ClkGen Spread Spectrum	Disabled
USB Controller	All USB Port
USB Legacy Support	Disabled
ESC : Quit            ↑↓→← : Select Item F1 : Help            PU/PD+/-/ : Modify F5 : Old Values (Shift)F2:Color F6 : Load BIOS Defaults F7 : Load SETUP Defaults	

Figure 4: Chipset Features Setup

- **Configure Time by SPD**

Disabled	Disable Configure Time by SPD function. <b>(Default Value)</b>
Enabled	Enable Configure Time by SPD function.

- **DRAM Frequency**

100MHz	Set DRAM Frequency to 100MHz. <b>(Default Value)</b>
133MHz	Set DRAM Frequency to 133MHz.

- **SDRAM CAS# Latency**

2	For Fastest SDRAM DIMM module.
3	For Slower SDRAM DIMM module. <b>(Default Value)</b>

- **AGP Mode**

4X	Set AGP Mode to 4X. <b>(Default Value)</b>
1X	Set AGP Mode to 1X.
2X	Set AGP Mode to 2X.

- **AGP Comp. Driving**

Auto	Set AGP Comp. Driving to Auto. <b>(Default Value)</b>
Manual	Set AGP Comp. Driving to Manual.

If AGP Comp. Driving is Manual.

Manual AGP Comp. Driving:	00-FF
---------------------------	-------

- **AGP Fast Write**

Enabled	Enable AGP Fast Write function.
Disabled	Disable this function. <b>(Default Value)</b>

- **AGP Aperture Size**

4MB	Set AGP Aperture Size to 4MB.
8MB	Set AGP Aperture Size to 8 MB.
16MB	Set AGP Aperture Size to 16 MB.
32MB	Set AGP Aperture Size to 32 MB.
64MB	Set AGP Aperture Size to 64 MB. <b>(Default Value)</b>
128MB	Set AGP Aperture Size to 128 MB.
256MB	Set AGP Aperture Size to 256 MB.

- **ClkGen Spread Spectrum**

Disabled	Disable ClkGen Spread Spectrum. <b>(Default Value)</b>
Enabled	Enable ClkGen Spread Spectrum.

- **USB Controller**

All USB Port	Set USB Controller to All USB Port. <b>(Default Value)</b>
Disabled	Disable USB Controller.
USB Port 0&1	Set USB Controller to USB Port 0&1.
USB Port 2&3	Set USB Controller to USB Port 2&3.

- **USB Legacy Support**

Keyboard/FDD	Set USB Legacy Support Keyboard / Floppy.
KB/Mouse/FDD	Set USB Legacy Support Keyboard / Mouse / Floppy.
Disabled	Disable USB Legacy Support Function. <b>(Default Value)</b>

## Power Management Setup

AMBIOS SETUP – POWER MANAGEMENT SETUP ( C ) 1999 American Megatrends, Inc. All Rights Reserved			
ACPI Standby State	S1/POS	RTC Alarm Hour	12
USB Dev Wakeup From S3~S5	Disabled	RTC Alarm Minute	30
Suspend Time Out (Minute)	Disabled	RTC Alarm Second	30
Display Activity	Ignore		
IRQ3	Monitor		
IRQ4	Monitor		
IRQ5	Ignore		
IRQ7	Monitor		
IRQ9	Ignore		
IRQ10	Ignore		
IRQ11	Ignore		
IRQ13	Ignore		
IRQ14	Monitor		
IRQ15	Ignore		
Soft-Off by Power Button	Instant-Off		
System after AC Back	Last State	ESC : Quit	↑↓→← : Select Item
Resume On Ring/LAN	Enabled	F1 : Help	PU/PD+/- : Modify
Resume On PME#	Enabled	F5 : Old Values	(Shift)F2:Color
Resume On RTC Alarm	Disabled	F6 : Load BIOS Defaults	
RTC Alarm Date	15	F7 : Load SETUP Defaults	

Figure 5: Power Management Setup

- **ACPI Standby State**

S1/POS	Set ACPI Standby State to S1. <b>(Default Value)</b>
S3/STR	Set ACPI Standby State to S3.

- **USB Dev Wakeup From S3~S5**

Enabled	Enable USB Dev Wakeup from ACPI S3, S4 and S5 mode.
Disabled	Disable USB Dev Wakeup from ACPI S3, S4 and S5 mode. <b>(Default Value)</b>

- **Suspend Time Out (Minute.)**

Disabled	Disable Suspend Time Out Function. <b>(Default Value)</b>
1	Enable Suspend Time Out after 1min.
2	Enable Suspend Time Out after 2min.
4	Enable Suspend Time Out after 4min.
8	Enable Suspend Time Out after 8min.
10	Enable Suspend Time Out after 10min.
20	Enable Suspend Time Out after 20min.
30	Enable Suspend Time Out after 30min.

40	Enable Suspend Time Out after 40min.
50	Enable Suspend Time Out after 50min.
60	Enable Suspend Time Out after 60min.

- **Display Activity**

Ignore	Ignore Display Activity. <b>(Default Value)</b>
Monitor	Monitor Display Activity.

- **IRQ 3-IRQ15**

Ignore	Ignore IRQ3 -IRQ15.
Monitor	Monitor IRQ3-IRQ15.

- **Soft-off by Power Button**

Instant-off	Soft switch ON/OFF for POWER ON/OFF. <b>(Default value)</b>
Suspend	Soft switch to enter Suspend Mode.

- **System after AC Back**

Last State	System power on depends on the status before AC lost. <b>(Default Value)</b>
Off	Always in Off state when AC back.
On	Always power on the system when AC back.

- **Resume On Ring / LAN**

Disabled	Disable Resume On Ring / LAN.
Enabled	Enable Resume On Ring / LAN. <b>(Default Value)</b>

- **Resume On PME#**

Disabled	Disable Resume On PME#.
Enabled	Enable Resume On PME#. <b>(Default Value)</b>

- **Resume On RTC Alarm**

You can set “Resume On RTC Alarm” item to enabled and key in Data/time to power on system.

Disabled	Disable this function. <b>(Default Value)</b>
Enabled	Enable alarm function to POWER ON system.

If the default value is Enabled.

RTC Alarm Date:	Every Day, 1~31
RTC Alarm Hour:	0~23
RTC Alarm Minute:	0~59
RTC Alarm Second:	0~59

## PNP/PCI Configurations

AMIBIOS SETUP – PNP / PCI CONFIGURATION ( C ) 1999 American Megatrends, Inc. All Rights Reserved	
VGA Frame Buffer Size	16MB
VGA Boot from	PCI
IRQ 3	PCI/PnP
IRQ 4	PCI/PnP
IRQ 5	PCI/PnP
IRQ 7	PCI/PnP
IRQ 9	PCI/PnP
IRQ 10	PCI/PnP
IRQ 11	PCI/PnP
IRQ 14	PCI/PnP
IRQ 15	PCI/PnP
ESC: Quit                      ↑↓→←: Select Item F1 : Help                      PU/PD+/-: Modify F5 :Old Values                (Shift)F2:Color F6 : Load BIOS Defaults F7 : Load SETUP Defaults	

Figure 6: PNP/PCI Configuration

- **VGA Frame Buffer Size**

8MB	Set VGA Frame Buffer Size to 8MB.
16MB	Set VGA Frame Buffer Size to 16MB. <b>(Default Value)</b>
32MB	Set VGA Frame Buffer Size to 32MB.

- **VGA Boot From**

AGP	Primary Graphics Adapter From AGP.
PCI	Primary Graphics Adapter From PCI. <b>(Default Value)</b>

- **IRQ (3, 4, 5, 7, 9, 10, 11, 14, 15)**

ISA/EISA	The resource is used by Legacy ISA device.
PCI/PnP	The resource is used by PCI/ PnP device. <b>(Default Value)</b>

## Load BIOS Defaults

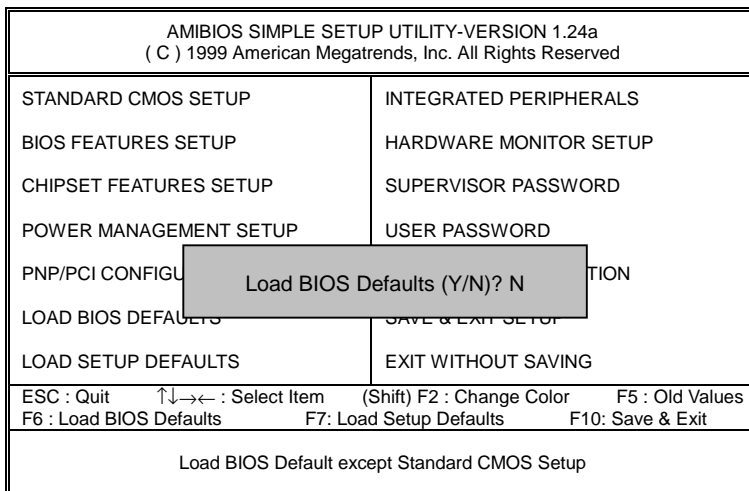

Figure 7: Load BIOS Defaults

- **Load BIOS Defaults**

BIOS defaults contain the most appropriate values of the system parameters that allow minimum system performance.



## Load Setup Defaults

AMIBIOS SIMPLE SETUP UTILITY-VERSION 1.24a ( C ) 1999 American Megatrends, Inc. All Rights Reserved	
STANDARD CMOS SETUP	INTEGRATED PERIPHERALS
BIOS FEATURES SETUP	HARDWARE MONITOR SETUP
CHIPSET FEATURES SETUP	SUPERVISOR PASSWORD
POWER MANAGEMENT SETUP	USER PASSWORD
PNP/PCI CONFIGURATION	LOAD SETUP Defaults (Y/N)? N
LOAD BIOS DEFAULTS	SAVE & EXIT SETUP
LOAD SETUP DEFAULTS	EXIT WITHOUT SAVING
ESC : Quit    ↑↓→← : Select Item    (Shift) F2 : Change Color    F5 : Old Values F6 : Load BIOS Defaults    F7: Load Setup Defaults    F10: Save & Exit	
Load Setup Default except Standard CMOS Setup	

Figure 8: Load Setup Defaults

- **Load Setup Defaults**

Selecting this field loads the factory defaults for BIOS and Chipset Features which the system automatically detects.

## Integrated Peripherals

AMIBIOS SETUP – INTEGRATED PERIPHERALS		( C ) 1999 American Megatrends, Inc. All Rights Reserved	
OnBoard FDC	Auto		
OnBoard Serial Port 1	Auto		
OnBoard Parallel Port	Auto		
Parallel Port Mode	ECP		
Parallel Port DMA	Auto		
Parallel Port IRQ	Auto		
OnBoard IDE	Both		
OnBoard AC'97 Audio	Auto		
OnBoard MC'97 Modem	Auto		
◆ OnBoard Legacy Audio	Enabled		
◆ Sound Blaster	Disabled		
◆ SB I/O Base Address	220h-22Fh		
◆ SB IRQ Select	5		
◆ SB DMA Select	1		
◆ MPU-401	Disabled		
◆ MPU-401 I/O Address	330h-333h		
◆ Game Port(200h-207h)	Enabled		
		ESC: Quit	↑↓→←: Select Item
		F1 : Help	PU/PD+/-: Modify
		F5 :Old Values	(Shift)F2:Color
		F6 : Load BIOS Defaults	
		F7 : Load SETUP Defaults	

Figure 9: Integrated Peripherals

- ◆ These eight items will be shown when there is only AC'97 CODEC sound.

- **Onboard FDC**

Auto	Auto detect OnBoard Floppy disk controller. <b>(Default value)</b>
Enabled	Enable OnBoard Floppy disk controller.
Disabled	Disable OnBoard Floppy disk controller.

- **On Board Serial Port 1**

Auto	BIOS will automatically setup the port 1 address. <b>(Default Value)</b>
3F8/COM1	Enable on Board Serial port 1 and address is 3F8.
2F8/COM2	Enable on Board Serial port 1 and address is 2F8.
3E8/COM3	Enable on Board Serial port 1 and address is 3E8.
2E8/COM4	Enable on Board Serial port 1 and address is 2E8.
Disabled	Disable on Board Serial port 1.

- **OnBoard Parallel port**

378	Enable On Board LPT port and address to 378.
278	Enable On Board LPT port and address to 278.

3BC	Enable On Board LPT port and address to 3BC.
Auto	Set On Board LPT port to Auto. <b>(Default Value)</b>
Disabled	Disable On Board LPT port.

- **Parallel Port Mode**

EPP	Using Parallel port as Enhanced Parallel Port.
ECP	Using Parallel port as Extended Capabilities Port. <b>(Default Value)</b>
Normal	Normal Operation.
EPP+ECP	Using Parallel port as Enhanced Parallel Port & Extended Capabilities Port.

- **Parallel Port DMA**

Auto	Set Auto to parallel port mode DMA Channel. <b>(Default Value)</b>
3	Set Parallel Port DMA to 3.
1	Set Parallel Port DMA to 1.
0	Set Parallel Port DMA to 0.

- **Parallel Port IRQ**

7	Set Parallel Port IRQ to 7.
Auto	Set Auto to parallel Port IRQ DMA Channel. <b>(Default Value)</b>
5	Set Parallel Port IRQ to 5.

- **OnBoard IDE**

Disabled	Disable OnBoard IDE.
Both	Set OnBoard IDE to Both. <b>(Default Value)</b>
Primary	Set OnBoard IDE to Primary.
Secondary	Set OnBoard IDE to Secondary.

- **OnBoard AC'97 Audio**

Auto	Auto detect OnBoard AC'97 Audio. <b>(Default Value)</b>
Disabled	Disable OnBoard AC'97 Audio.

- **OnBoard MC'97 Modem**

Auto	Auto detect OnBoard MC'97 Modem. <b>(Default Value)</b>
Disabled	Disable OnBoard MC'97 Modem.

- **OnBoard Legacy Audio**

Enabled	Enable OnBoard Legacy Audio. <b>(Default Value)</b>
Disabled	Disable OnBoard Legacy Audio.

- **Sound Blaster**

Enabled	Enable Sound Blaster.
Disabled	Disable Sound Blaster. <b>(Default Value)</b>

- **SB I/O Base Address**

220h-22Fh	Set SB I/O Base Address to 220h-22Fh. <b>(Default Value)</b>
240h-24Fh	Set SB I/O Base Address to 240h-24Fh.
260h-26Fh	Set SB I/O Base Address to 260h-26Fh.
280h-28Fh	Set SB I/O Base Address to 280h-28Fh.

- **SB IRQ Select**

IRQ 5 / 7 / 9 / 10. <b>(Default Value: 5)</b>
---

- **SB DMA Select**

DMA 0 / 1 / 2 / 3. <b>(Default Value: 1)</b>
--

- **MPU-401**

Enabled	Enable MPU-401.
Disabled	Disable MPU-401. <b>(Default Value)</b>

Ps. When Force Feedback joystick is used, MPU-401 needs to be Enable.

- **MPU-401 I/O Address**

330h-333h	Set MPU-401 I/O Address to 330h-333h. <b>(Default Value)</b>
300h-303h	Set MPU-401 I/O Address to 300h-303h.
310h-313h	Set MPU-401 I/O Address to 310h-313h.
320h-323h	Set MPU-401 I/O Address to 320h-323h.

- **Game Port (200h-207h)**

Disabled	Disable Game Port (200h-207h).
Enabled	Enable Game Port (200h-207h). <b>(Default Value)</b>

## Hardware Monitor

AMIBIOS SETUP – HARDWARE MONITOR SETUP	
( C ) 1999 American Megatrends, Inc. All Rights Reserved	
CPU Temperature	47°C/116°F
System Temperature	32°C/89°F
CPU Fan Speed	7123 RPM
System Fan Speed	0 RPM
Vcore	1.750 V
Vdd	3.050 V
Vcc3	3.340 V
+5.000V	4.996 V
+12.000V	12.166 V
ESC: Quit                    ↑↓→←: Select Item F1 : Help                    PU/PD+/-/: Modify F5 :Old Values (Shift)F2:Color F6 : Load BIOS Defaults F7 : Load Setup Defaults	

Figure 10: Hardware Monitor

- **CPU Temperature. (°C / °F)**  
Detect CPU Temperature automatically.
- **System Temperature. (°C / °F)**  
Detect System Temperature automatically.
- **CPU Fan Speed**  
Detect CPU Fan speed status automatically.
- **System Fan Speed**  
Detect System Fan speed status automatically.
- **Voltage (V) Vcore / Vdd / Vcc3 / +5V / +12V**  
Detect system's voltage status automatically.

## Set Supervisor / User Password

When you select this function, the following message will appear at the center of the screen to assist you in creating a password.

AMIBIOS SIMPLE SETUP UTILITY-VERSION 1.24a ( C ) 1999 American Megatrends, Inc. All Rights Reserved	
STANDARD CMOS SETUP	INTEGRATED PERIPHERALS
BIOS FEATURES SETUP	HARDWARE MONITOR SETUP
CHIPSET FEATURES SETUP	SUPERVISOR PASSWORD
POWER MANAGEMENT SETUP	USER PASSWORD
PNP/PCI CONFIGURATION	Enter new supervisor password: <input type="text"/> ON
LOAD BIOS DEFAULTS	SAVE & EXIT SETUP
LOAD SETUP DEFAULTS	EXIT WITHOUT SAVING
ESC : Quit    ↑↓→← : Select Item    (Shift) F2 : Change Color    F5 : Old Values F6 : Load BIOS Defaults    F7 : Load Setup Defaults    F10 : Save & Exit	
Chang /Set /Disabled Password	

Figure 11: Password Setting

Type the password, up to six characters, and press <Enter>. You will be asked to confirm the password. Type the password again and press <Enter>. You may also press <Esc> to abort the selection and not enter a password.

To disable password, just press <Enter> when you are prompted to enter password. A message **"PASSWORD DISABLED"** will appear to confirm the password being disabled. Once the password is disabled, the system will boot and you can enter Setup freely.

The BIOS Setup program allows you to specify two separate passwords: a **SUPERVISOR PASSWORD** and a **USER PASSWORD**. When disabled, anyone may access all BIOS Setup program function. When enabled, the Supervisor password is required for entering the BIOS Setup program and having full configuration fields, the User password is required to access only basic items.

If you select **"Always"** at **"Password Check"** in BIOS Features Setup Menu, you will be prompted for the password every time the system is rebooted or any time you try to enter Setup Menu.

If you select **"Setup"** at **"Password Check"** in BIOS Features Setup Menu, you will be prompted only when you try to enter Setup.

## IDE HDD AUTO Detection

AMIBIOS SETUP – STANDARD CMOS SETUP ( C ) 1999 American Megatrends, Inc. All Rights Reserved							
Date (mm/dd/yyyy) : Tue Jan 25, 2000							
Time (hh/mm/ss) : 10:36:24							
TYPE	SIZE	CYLS	HEAD	PRECOMP	LANDZ	SECTOR	MODE
Pri Master : Not Installed							
Pri Slave : Not Installed							
Sec Master : Not Installed							
Sec Slave : Not Installed							
Floppy Drive A: 1.44 MB 3 ½				Base Memory : 640 Kb			
Floppy Drive B: Not Installed				Other Memory: 384 Kb			
				Extended Memory: 31Mb			
Boot Sector Virus Protection : Disabled				Total Memory: 32Mb			
Month: Jan – Dec				ESC : Exit			
Day: 01 – 31				↑↓ : Select Item			
Year: 1990– 2099				PU/PD/+/- : Modify			
				(Shift)F2 : Color			

Figure 12: IDE HDD Auto Detection

Type "Y" will accept the H.D.D. parameter reported by BIOS.

Type "N" will keep the old H.D.D. parameter setup. If the hard disk cylinder number is over 1024, then the user can select LBA mode or LARGER mode for DOS partition larger than 528 MB.

## Save & Exit Setup

AMIBIOS SIMPLE SETUP UTILITY-VERSION 1.24a ( C ) 1999 American Megatrends, Inc. All Rights Reserved	
STANDARD CMOS SETUP	INTEGRATED PERIPHERALS
BIOS FEATURES SETUP	HARDWARE MONITOR SETUP
CHIPSET FEATURES SETUP	SUPERVISOR PASSWORD
POWER MANAGEMENT SETUP	USER PASSWORD
PNP/PCI CONFIGURATION	
LOAD BIOS DEFAULTS	LOAD SETUP DEFAULTS
	EXIT WITHOUT SAVING
SAVE to CMOS and EXIT(Y/N)? Y	
ESC : Quit    ↑↓→← : Select Item    (Shift) F2 : Change Color    F5 : Old Values F6 : Load BIOS Defaults    F7: Load Setup Defaults    F10: Save & Exit	
Save Data to CMOS & Exit Setup	

Figure 13: Save & Exit Setup

Type "Y" will quit the Setup Utility and save the user setup value to RTC CMOS.

Type "N" will return to Setup Utility.



## Exit Without Saving

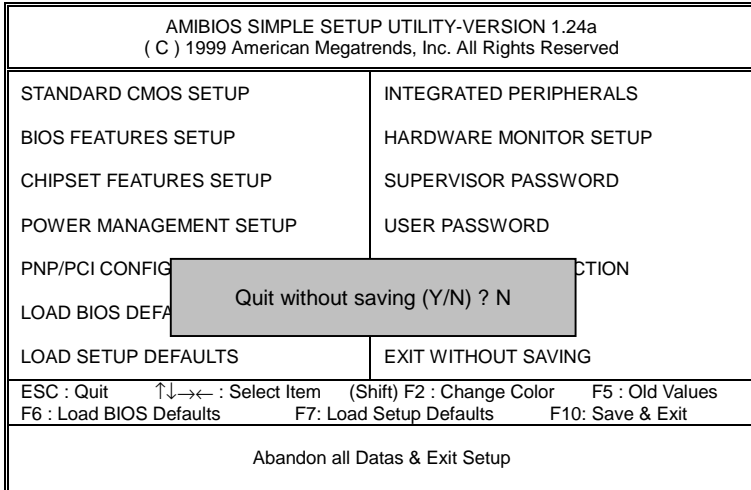

Figure 14: Exit Without Saving

Type "Y" will quit the Setup Utility without saving to RTC CMOS.

Type "N" will return to Setup Utility.

# Appendix

## Appendix A: VIA VT8365/VT8364 Chipsets Driver Installation

### A.VIA 4 in 1 Service Pack Utility:

Insert the support CD that came with your motherboard into your CD-ROM driver or double –click the CD driver icon in My Computer to bring up the screen.

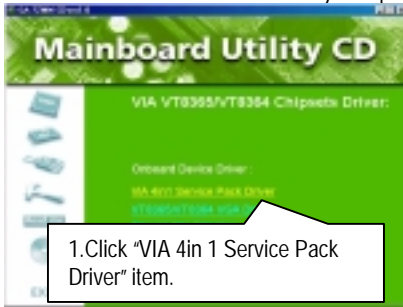

(1)

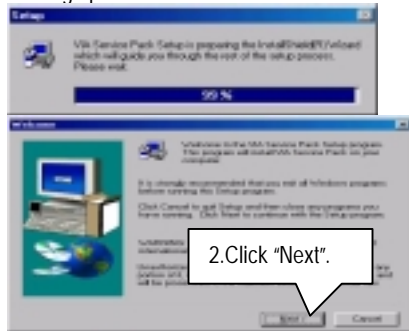

(2)

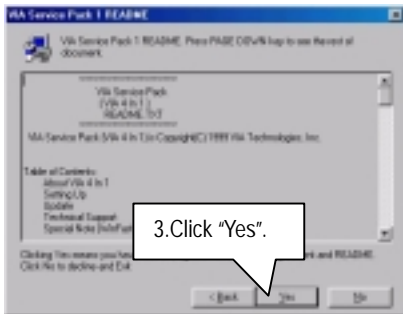

(3)

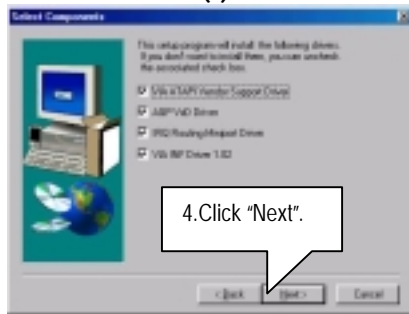

(4)

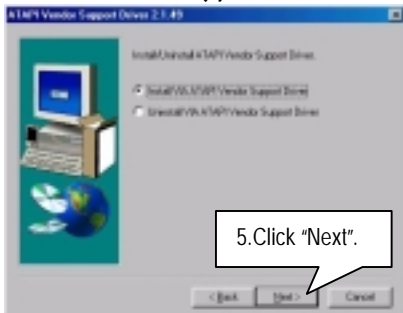

(5)

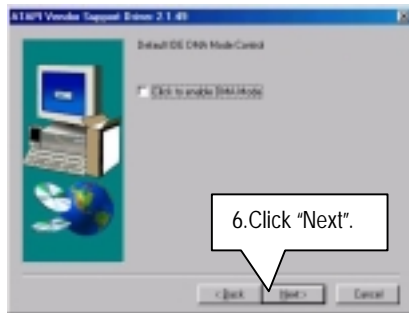

(6)

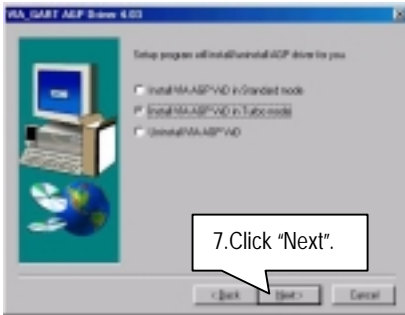

(7)

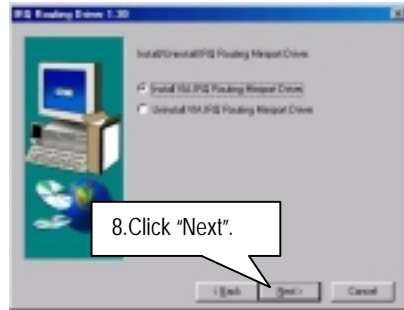

(8)



(9)

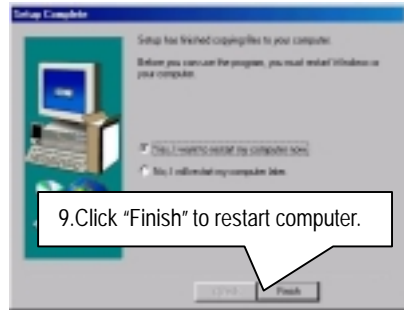

(10)

### B.VT8365/VT8364 VGA Driver:

Insert the support CD that came with your motherboard into your CD-ROM driver or double –click the CD driver icon in My Computer to bring up the screen.

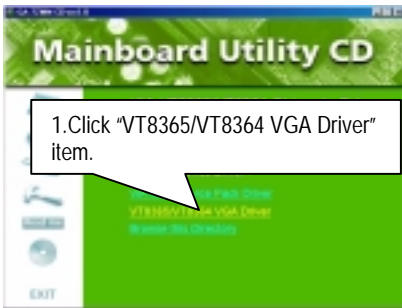

(1)

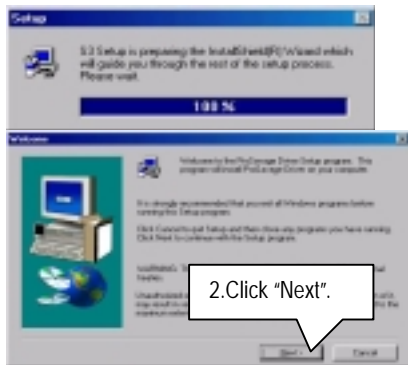

(2)

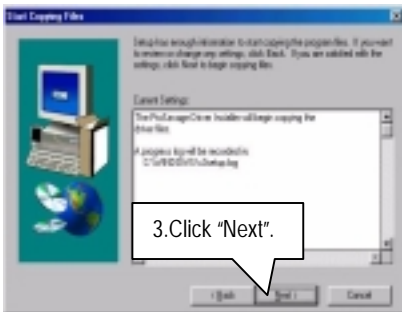

(3)

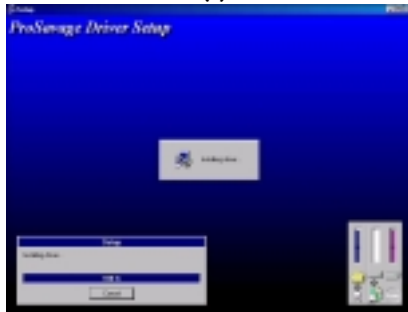

(4)

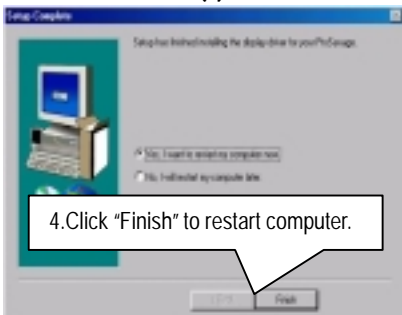

(5)

## Appendix B: Creative Sound Driver Installation (Optional)

Insert the support CD that came with your motherboard into your CD-ROM driver or double-click the CD driver icon in My Computer to bring up the screen.

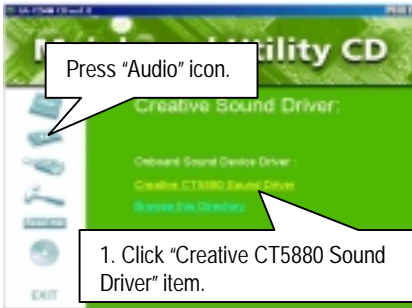

(1)



(2)

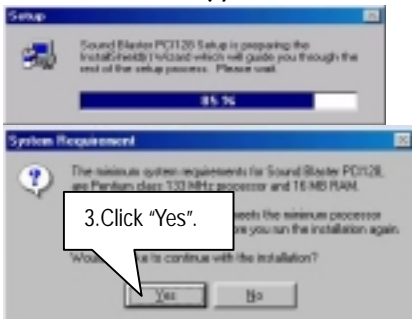

(3)

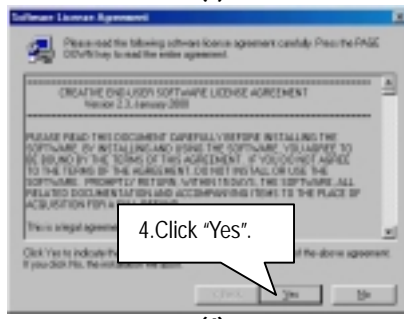

(4)

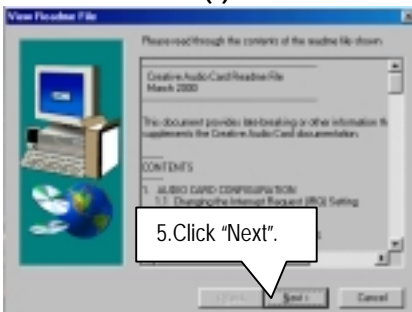

(5)

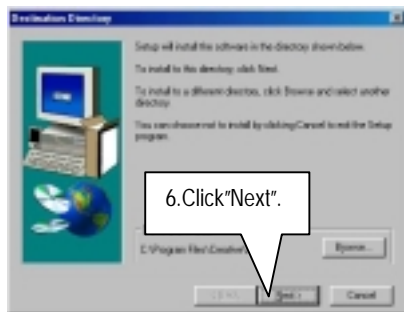

(6)

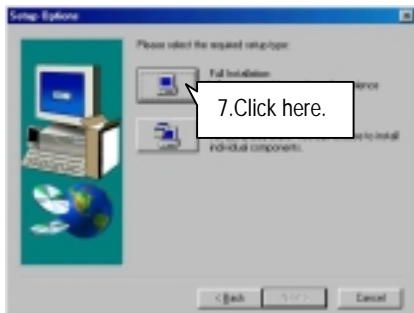

(7)

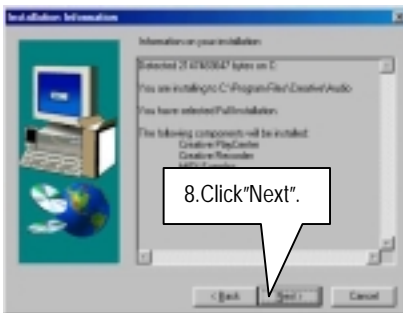

(8)



(9)

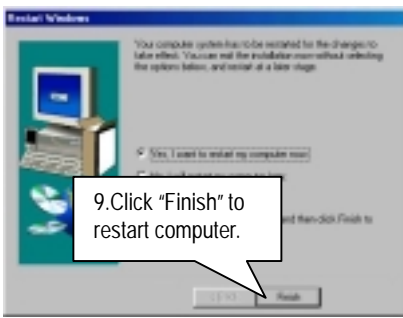

(10)

## Appendix C: VIA AC'97 Audio Driver

Insert the support CD that came with your motherboard into your CD-ROM driver or double-click the CD driver icon in My Computer to bring up the screen.

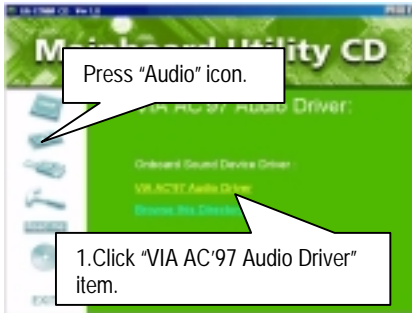

(1)

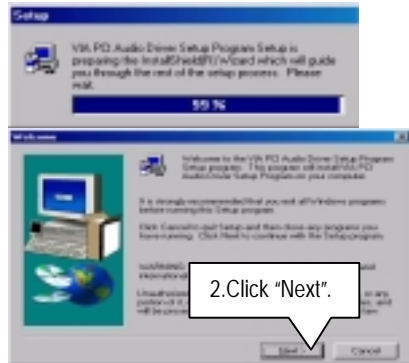

(2)

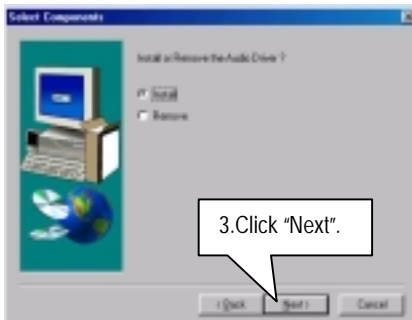

(3)

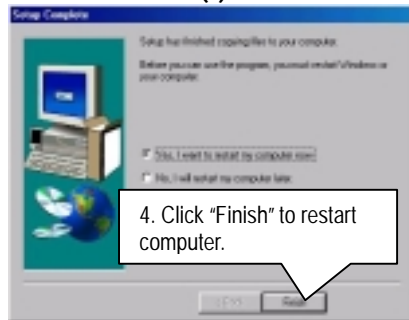

(4)

## Appendix D: EasyTuneIII Setup

Insert the support CD that came with your motherboard into your CD-ROM driver or double-click the CD driver icon in My Computer to bring up the screen.

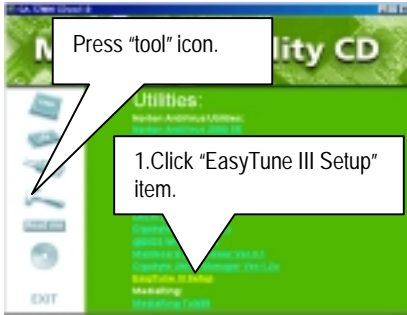

(1)

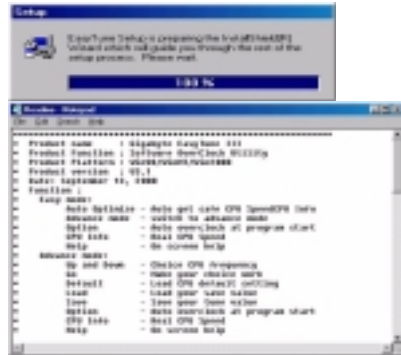

(2)

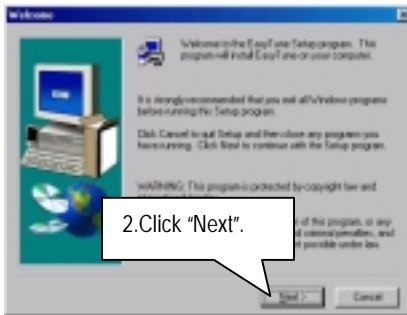

(3)

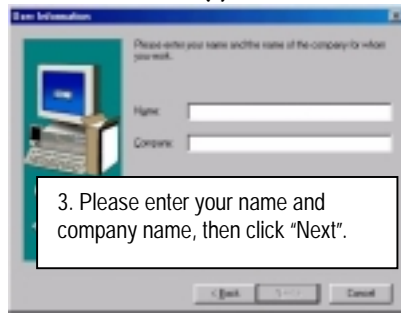

(4)

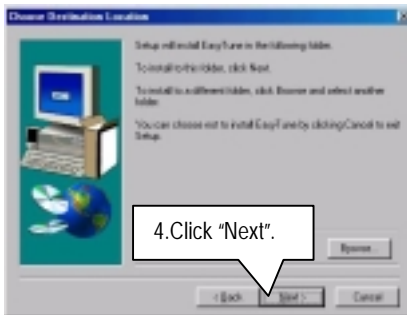

(5)

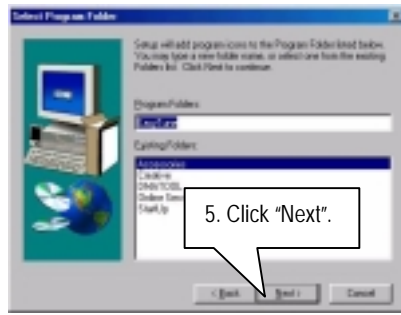

(6)



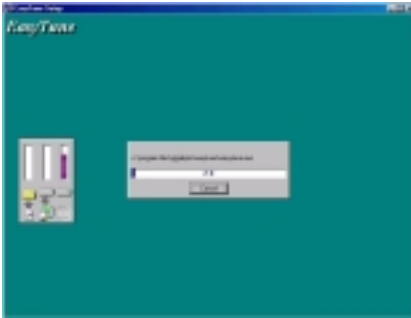

(7)

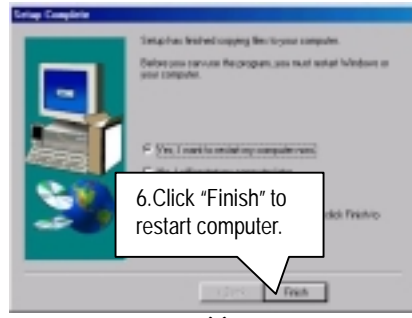

(8)

## Appendix E: BIOS Flash Procedure

BIOS update procedure:

If your OS is Win9X, we recommend that you used Gigabyte @BIOS™ Program to flash BIOS.

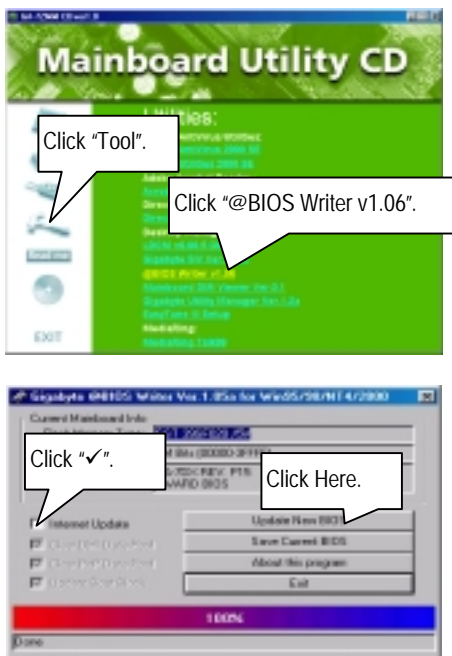

Methods and steps:

- I. Update BIOS through Internet
  - a. Click "Internet Update" icon
  - b. Click "Update New BIOS" icon
  - c. Select @BIOS™ sever ( "Gigabyte @BIOS™ sever 1 in Taiwan" and "Gigabyte @BIOS™ sever 2 in Taiwan" are available for now, the others will be completed soon)
  - d. Select the exact model name on your motherboard
  - e. System will automatically download and update the BIOS.

II. Update BIOS **NOT** through Internet:

- a. **Do not** click "Internet Update" icon
- b. Click "Update New BIOS"
- c. Please select "All Files" in dialog box while opening the old file.
- d. Please search for BIOS unzip file, downloading from internet or any other methods (such as: 7ZMMC.F1).
- e. Complete update process following the instruction.

III. Save BIOS

In the very beginning, there is "Save Current BIOS" icon shown in dialog box. It means to save the current BIOS version.

IV. Check out supported motherboard and Flash ROM:

In the very beginning, there is "About this program" icon shown in dialog box. It can help you check out which kind of motherboard and which brand of Flash ROM are supported.

Note:

- a. In method I, if it shows two or more motherboard's model names to be selected, please make sure your motherboard's model name again. Selecting name will cause the system unbooted.
- b. In method II, be sure that motherboard's model name in BIOS unzip file are the same as your motherboard's. Otherwise, your system won't boot.
- c. In method I, if the BIOS file you need cannot be found in @BIOS™ server, please go onto Gigabyte's web site for downloading and updating it according to method II.
- d. Please note that any interruption during updating will cause system unbooted

Or else you can select flash BIOS in DOS mode.

● Please check your **BIOS vendor (AMI or AWARD)**, your **motherboard name** and **PCB version** on the motherboard.

1. Format a bootable system floppy diskette by the command "**format a:/s**" in command mode.
2. Visit the Gigabyte website at [http:// www.gigabyte.com.tw](http://www.gigabyte.com.tw) , Select the BIOS file you need and download it to your bootable floppy diskette.
3. Insert the bootable diskette containing the BIOS file into the floppy diskette driver.
4. Assuming that the floppy diskette driver is A, reboot the system by using the A: driver. At the A: > prompt, run the BIOS upgraded file by executing the Flash BIOS utility and the BIOS file with its appropriate extension.

Example: *(AMI tool) (Where 7zmmc.f1 is name of the BIOS file name)*

```
A:>flashxxx.exe 7zmmc.f1 ←↵
```

Example: *(Award tool) (Where 7zmmc.f1 is name of the BIOS file name)*

```
A:>Awdflash.exe 7zmmc.f1 ←↵
```

5. Upon pressing the <Enter> key, a flash memory writer menu will appear on screen. Enter the new BIOS file name with its extension filename into the text box after file name to program.
6. If you want to save the old BIOS file(perform as soon as system is operational, this is recommended), select Y to **DO YOU WANT TO SAVE BIOS**, then type the old BIOS filename and the extension after filename to save: This option allows you to copy the contents of the flash memory chip onto a diskette, giving you a backup copy of the original motherboard BIOS in case you need to re-install it. Select N to **DO YOU WANT TO SAVE BIOS**, if you don't want to save the old BIOS file.
7. After the decision to save the old BIOS file or not is made, select Y to **ARE YOU SURE TO PROGRAM** when the next menu appear; wait until a message showing Power Off or Reset the system appears. Then turn off your system.
8. Remove the diskette and restart your system.
9. Hold down <Delete> key to enter BIOS setup. You must select "Load Setup BIOS Default" to activate the new BIOS, then you may set other item from the main menu.

---

## Appendix F: Issues To Beware Of When Installing CNR

Please use standard CNR card like the one in order to avoid mechanical problem.  
(See Figure A)

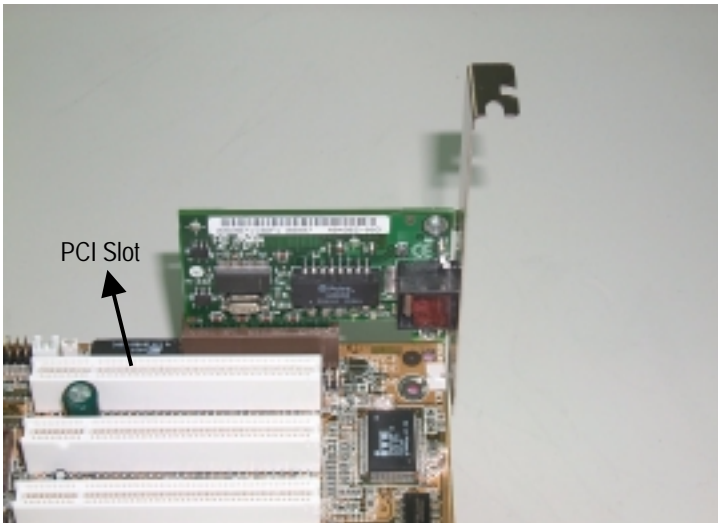

Figure A: Standard CNR Card

## Appendix G: Acronyms

Acronyms	Meaning
ACPI	Advanced Configuration and Power Interface
APM	Advanced Power Management
AGP	Accelerated Graphics Port
AMR	Audio Modem Riser
ACR	Advanced Communications Riser
BIOS	Basic Input / Output System
CPU	Central Processing Unit
CMOS	Complementary Metal Oxide Semiconductor
CRIMM	Continuity RIMM
CNR	Communication and Networking Riser
DMA	Direct Memory Access
DMI	Desktop Management Interface
DIMM	Dual Inline Memory Module
DRM	Dual Retention Mechanism
DRAM	Dynamic Random Access Memory
DDR	Double Data Rate
ECP	Extended Capabilities Port
ESCD	Extended System Configuration Data
ECC	Error Checking and Correcting
EMC	Electromagnetic Compatibility
EPP	Enhanced Parallel Port
ESD	Electrostatic Discharge
FDD	Floppy Disk Device
FSB	Front Side Bus
HDD	Hard Disk Device
IDE	Integrated Dual Channel Enhanced
IRO	Interrupt Request
I/O	Input / Output
IOAPIC	Input Output Advanced Programmable Input Controller
ISA	Industry Standard Architecture
LAN	Local Area Network
LBA	Logical Block Addressing
LED	Light Emitting Diode
MHz	Megahertz
MIDI	Musical Interface Digital Interface
MTH	Memory Translator Hub
MPT	Memory Protocol Translator
NIC	Network Interface Card
OS	Operating System

To be continued...

---

Acronyms	Meaning
OEM	Original Equipment Manufacturer
PAC	PCI A.G.P. Controller
POST	Power-On Self Test
PCI	Peripheral Component Interconnect
RIMM	Rambus in-line Memory Module
SCI	Special Circumstance Instructions
SECC	Single Edge Contact Cartridge
SRAM	Static Random Access Memory
SMP	Symmetric Multi-Processing
SMI	System Management Interrupt
USB	Universal Serial Bus
VID	Voltage ID