



When you installing AGP card, please make sure the following notice is fully understood and practiced. If your AGP card has "AGP 4X notch"(show below), please make sure your AGP card is AGP 4X (1.5V).



Do not use AGP 2X card (3.3V) in this motherboard. It will burn and damage the motherboard due to Intel® 850 chipset can't support AGP 2X(3.3V).

Example 1: Diamond Vipper V770 golden finger is compatible with 2X/4X mode AGP slot. It can be switched between AGP 2X (3.3V) or 4X(1.5V) mode by adjusting the jumper. The factory default for this card is 2X(3.3V). If you install this card in GA-8ITX3 (or any AGP 4X only) motherboards without switching the jumper to 4X mode (1.5V), it will burn the motherboard.

Example 2: ATi Rage 128 Pro (Power Color) & SiS 305 golden finger is compatible with 2X/4X mode AGP slot, but it supports 2X(3.3V) only. If you install this card in GA-8ITX3 (or any AGP 4X only) motherboards, it will burn the motherboard.



- The author assumes no responsibility for any errors or omissions that may appear in this document nor does the author make a commitment to update the information contained herein.
- Third-party brands and names are the property of their respective owners.
- Please do not remove any labels on motherboard, this may void the warranty of this motherboard.
- Due to rapid change in technology, some of the specifications might be out of date before publication of this booklet.



DECLARATION OF CONFORMITY

Per FCC Part 2 Section 2.1077(a)



Responsible Party Name: G.B.T. INC.

**Address: 18305 Valley Blvd., Suite#A LA
Puent, CA 91744**

Phone/Fax No: (818) 854-9338/ (818) 854-9339

hereby declares that the product

Product Name: Motherboard

Model Number: GA-8ITX3

Conforms to the following specifications:

FCC Part 15, Subpart B, Section 15.107(a) and Section 15.109(a),
Class B Digital Device

Supplementary Information:

This device complies with part 15 of the FCC Rules. Operation is subject to the following two conditions: (1) This device may not cause harmful and (2) this device must accept any inference received, including that may cause undesired operation.

Representative Person's Name: ERIC LU

Signature: Eric Lu

Date: Oct. 19,2001

Declaration of Conformity

We, Manufacturer/Importer
(full address)

G.B.T. Technology Trading GmbH
Ausschlagler Weg 41, 1F, 20537 Hamburg, Germany

declare that the product
(description of the apparatus, system, installation to which it refers)

Mother Board

GA-8ITX3

is in conformity with

(reference to the specification under which conformity is declared)

in accordance with 89/336 EEC-EMC Directive

- | | | | |
|---|--|--|--|
| <input type="checkbox"/> EN 55011 | Limits and methods of measurement of radio disturbance characteristics of industrial, scientific and medical (ISM) high frequency equipment | <input type="checkbox"/> EN 61000-3-2*
<input checked="" type="checkbox"/> EN 60555-2 | Disturbances in supply systems cause by household appliances and similar electrical equipment "Harmonics" |
| <input type="checkbox"/> EN 55013 | Limits and methods of measurement of radio disturbance characteristics of broadcast receivers and associated equipment | <input type="checkbox"/> EN 61000-3-3*
<input checked="" type="checkbox"/> EN 60555-3 | Disturbances in supply systems cause by household appliances and similar electrical equipment "Voltage fluctuations" |
| <input type="checkbox"/> EN 55014 | Limits and methods of measurement of radio disturbance characteristics of household electrical appliances, portable tools and similar electrical apparatus | <input checked="" type="checkbox"/> EN 50081-1
<input checked="" type="checkbox"/> EN 50082-1 | Generic emission standard Part 1: Residual commercial and light industry
Generic immunity standard Part 1: Residual commercial and light industry |
| <input type="checkbox"/> EN 55015 | Limits and methods of measurement of radio disturbance characteristics of fluorescent lamps and luminaries | <input type="checkbox"/> EN 55081-2 | Generic emission standard Part 2: Industrial environment |
| <input type="checkbox"/> EN 55020 | Immunity from radio interference of broadcast receivers and associated equipment | <input type="checkbox"/> EN 55082-2 | Generic emission standard Part 2: Industrial environment |
| <input checked="" type="checkbox"/> EN 55022 | Limits and methods of measurement of radio disturbance characteristics of information technology equipment | <input type="checkbox"/> EN 55104 | Immunity requirements for household appliances tools and similar apparatus |
| <input type="checkbox"/> DIN VDE 0855
<input type="checkbox"/> part 10
<input type="checkbox"/> part 12 | Cabled distribution systems: Equipment for receiving and/or distribution from sound and television signals | <input type="checkbox"/> EN50091-2 | EMC requirements for uninterruptible power systems (UPS) |

CE marking



(EC conformity marking)

The manufacturer also declares the conformity of above mentioned product with the actual required safety standards in accordance with LVD 73/23 EEC

- | | | |
|-----------------------------------|---|-------------------------------------|
| <input type="checkbox"/> EN 60065 | Safety requirements for mains operated electronic and related apparatus for household and similar general use | <input type="checkbox"/> EN 60950 |
| <input type="checkbox"/> EN 60335 | Safety of household and similar electrical appliances | <input type="checkbox"/> EN 50091-1 |

Manufacturer/Importer

(Stamp)

Date : Oct. 19, 2001

Signature: Rex Lin
Name: Rex Lin

GA-8ITX3
Pentium® 4 Processor Motherboard

USER'S MANUAL

Pentium® 4 Processor Motherboard
Rev. 1.0 First Edition
12ME-8ITX3-1001

Table of Content

Revision History.....	4
Item Checklist	4
WARNING!	5
Chapter 1 Introduction	6
Summary of Features	6
GA-8ITX3 Motherboard Layout	8
Chapter 2 Hardware Installation Process	9
Step 1: Install the Central Processing Unit (CPU).....	10
Step1-1:CPU Installation	11
Step 1-2: CPU Heat Sink Installation	12
Step 2: Install memory modules	13
Step 2-1:Introduce RIMM (Rambus In-line Memory Module)	14
Step 3: Install expansion cards	15
Step 4: Connect ribbon cables, cabinet wires, and power supply	16
Step 4-1: I/O shield Introduction	16
Step 4-2:Connectors Introduction	18
Step 4-3: ATX 12V Power Supply Introduction	25
Step 4-4: 6 Pin Aux. Power Connector	25

Chapter 3 BIOS Setup	26
The Main Menu (For example: BIOS Ver. :F1)	28
Standard CMOS Features	30
BIOS Features Setup	33
Chipset Features Setup	35
Power Management Setup	37
PNP/PCI Configuration	41
Load Fail-Safe Defaults	43
Load Optimized Defaults	44
Integrated Peripherals	45
Hardware Monitor & MISC Setup	51
Set Supervisor / User Password	53
IDE HDD Auto Detection	54
Save & Exit Setup	55
Exit Without Saving	56
Chapter 4 Technical Reference	57
Performance List	57
Block Diagram	58
Q-Flash Utility Introduction	59
@ BIOS Introduction	61
Easy Tunell™ Introduction	62
Chapter 5 Appendix	63

Revision History

Revision	Revision Note	Date
1.0	Initial release of the GA-8ITX3 motherboard user's manual.	Oct.2001

Item Checklist

- The GA-8ITX3 motherboard
- IDE cable x 1 / Floppy cable x 1
- USB cable x 1
- CD for motherboard driver & utility (IUCD)
- GA-8ITX3 user's manual
- I/O Shield
- Processor heat sink attach clips x2
- Screw x 4
- Quick PC Installation Guide
- CRIMM x 2

WARNING!

Computer motherboards and expansion cards contain very delicate Integrated Circuit (IC) chips. To protect them against damage from static electricity, you should follow some precautions whenever you work on your computer.

1. Unplug your computer when working on the inside.
2. Use a grounded wrist strap before handling computer components. If you do not have one, touch both of your hands to a safely grounded object or to a metal object, such as the power supply case.
3. Hold components by the edges and try not touch the IC chips, leads or connectors, or other components.
4. Place components on a grounded antistatic pad or on the bag that came with the components whenever the components are separated from the system.
5. Ensure that the ATX power supply is switched off before you plug in or remove the ATX power connector on the motherboard.

Installing the motherboard to the chassis...

If the motherboard has mounting holes, but they don't line up with the holes on the base and there are no slots to attach the spacers, do not become alarmed you can still attach the spacers to the mounting holes. Just cut the bottom portion of the spacers (the spacer may be a little hard to cut off, so be careful of your hands). In this way you can still attach the motherboard to the base without worrying about short circuits. Sometimes you may need to use the plastic springs to isolate the screw from the motherboard PCB surface, because the circuit wire may be near by the hole. Be careful, don't let the screw contact any printed circuit write or parts on the PCB that are near the fixing hole, otherwise it may damage the board or cause board malfunctioning.

Chapter 1 Introduction

Summary of Features

Form Factor	<ul style="list-style-type: none">• 30.5cm x 24.5cm ATX size form factor, 4 layers PCB.
CPU	<ul style="list-style-type: none">• Socket 423 processor• Intel Pentium®4 400MHz FSB• 2nd Level cache depend on CPU
Chipset	<ul style="list-style-type: none">• Chipset 82850 HOST/AGP/Controller• 82801BA(ICH2) I/O Controller Hub
Memory	<ul style="list-style-type: none">• 4 184-pin RIMM Sockets• Dual direct RDRAM channel• Supports up to 2GB (Max)
I/O Control	<ul style="list-style-type: none">• Winbond W83627HF
Slots	<ul style="list-style-type: none">• 1 CNR(Communication and Networking Riser) Slot• 1 AGP support 4X(1.5V) device• 5 PCI slot supports 33MHz & PCI 2.2 compliant
On-Board IDE	<ul style="list-style-type: none">• An IDE controller on the Intel 82801BA PCI chipset provides IDE HDD/CD-ROM with PIO, Bus Master (Ultra DMA33/ATA66/ATA100) operation modes.• Can connect up to four IDE devices
On-Board Peripherals	<ul style="list-style-type: none">• 1 Floppy port supports 2 FDD with 360K, 720K, 1.2M, 1.44M and 2.88M bytes.• 1 Parallel port supports Normal/EPP/ECP mode• 2 Serial ports (COMA&COMB)• 4 USB ports (Rear USB x 2, Front USB x 2)• 1 IrDA connector for IR/CIR
Hardware Monitor	<ul style="list-style-type: none">• CPU/Power/System Fan Revolution detect• CPU Overheat Warning• System Voltage Detect

to be continued.....

On-Board Sound	<ul style="list-style-type: none">• AC97 CODEC• Line In/Line Out/Mic In/CD In/Game Port
PS/2 Connector	<ul style="list-style-type: none">• PS/2 Keyboard interface and PS/2 Mouse interface
BIOS	<ul style="list-style-type: none">• Licensed AMI BIOS, 2M bit FWH• Supports Dual BIOS
Additional Features	<ul style="list-style-type: none">• PS/2 Keyboard power on by password• PS/2 Mouse power on• External Modem wake up• STR(Suspend-To-RAM)• Wake on LAN• AC Recovery• USB KB/Mouse wake up from S3• Supports @BIOS• Supports EasyTunell

- Please set the CPU host frequency in accordance with your processor's specifications. We don't recommend you to set the system bus frequency over the CPU's specification because these specific bus frequencies are not the standard specifications for CPU, chipset and most of the peripherals. Whether your system can run under these specific bus frequencies properly will depend on your hardware configurations, including CPU, Chipsets, SDRAM, Cards...etc.

GA-8ITX3 Motherboard Layout

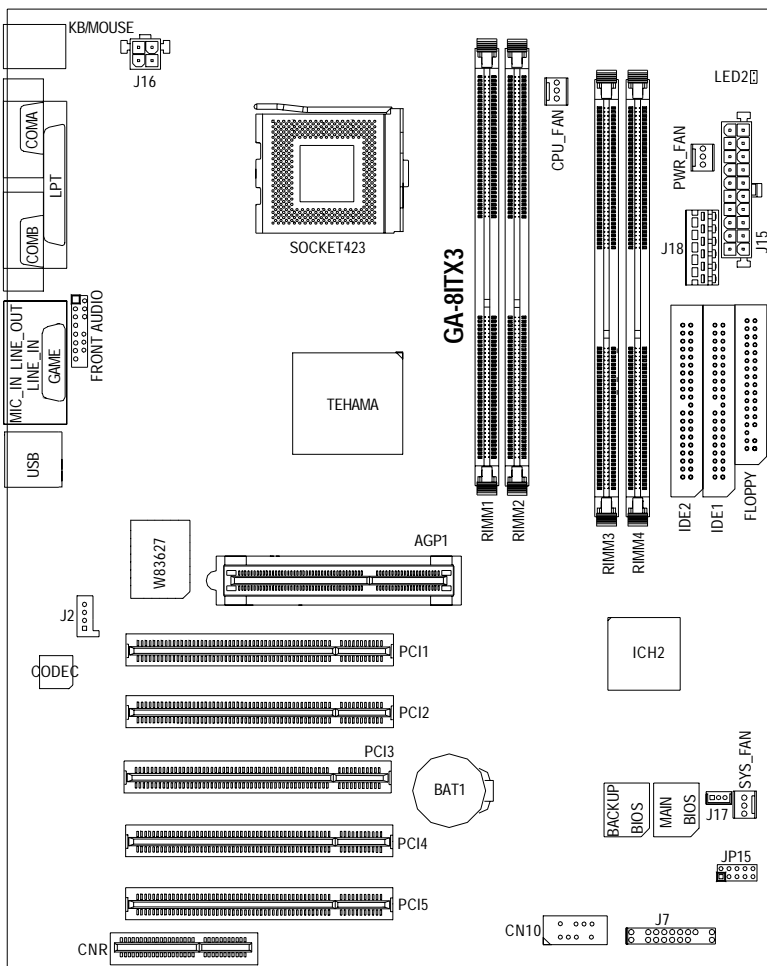

Chapter 2 Hardware Installation Process

To set up your computer, you must complete the following setups:

- Step 1- Install the Central Processing Unit (CPU)
- Step 2- Install memory modules
- Step 3- Install expansion cards
- Step 4- Connect ribbon cables, cabinet wires, and power supply
- Step 5- Setup BIOS software
- Step 6- Install supporting software tools

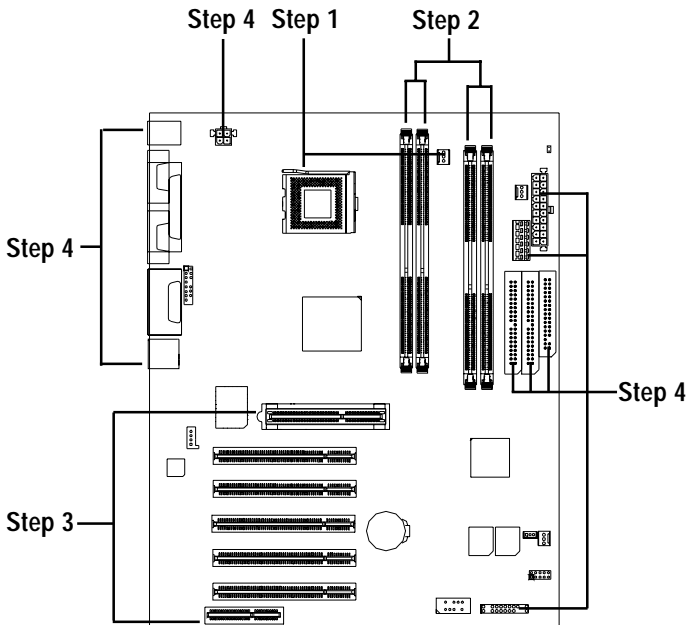

Step 1: Install the Central Processing Unit (CPU)

Before You will know.....



You may use the 4 screws which come with the mainboard to reinforce the support between P4 CPU heat-sink on the mainboard and chassis.

In order to follow the installation steps below; your chassis must be WILLMETTE/850 board design compatible.

Step1: The 4 new mounting holes on the chassis are for additional support for P4 CPU heat-sink on the mainboard.

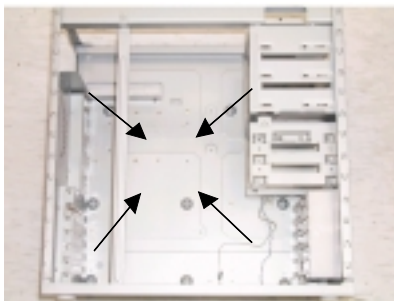

Figure1

Step2: Please remove 4 sets of plastic Push-pins as indicated on Figure2. Remove the white pins first, then black pins as indicated on Figure3.

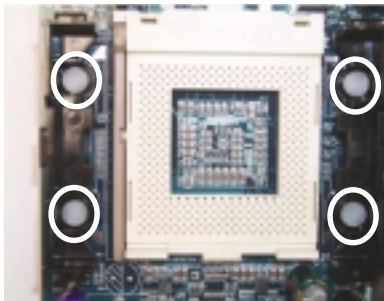

Figure2

Step3:



Figure3

Step4: Fit the 4 screws with 2 CPU retention modules on the chassis.

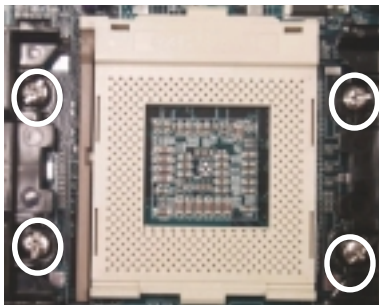

Figure4

Step1-1:CPU Installation



CPU Top View



CPU Bottom View

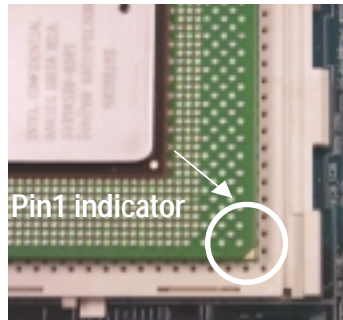
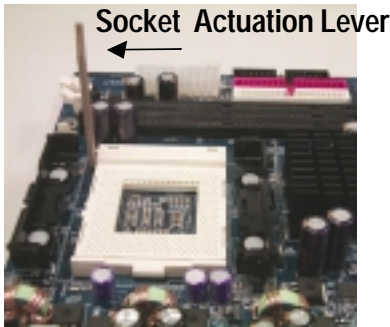

1. Pull up the CPU socket level and up to 90-degree angle.
2. Locate Pin 1 in the socket and look for a (golden) cut edge on the CPU upper corner. Then insert the CPU into the socket.
3. Press down the CPU socket lever and finish CPU installation.

● Please make sure the CPU type is supported by the motherboard.

Step 1-2: CPU Heat Sink Installation



1. Align CPU and insert it

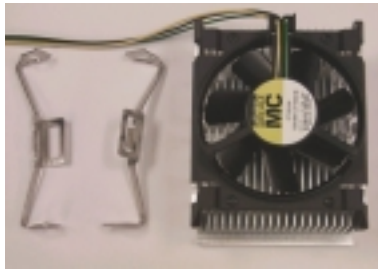

2. Use qualified fan approved by Intel.

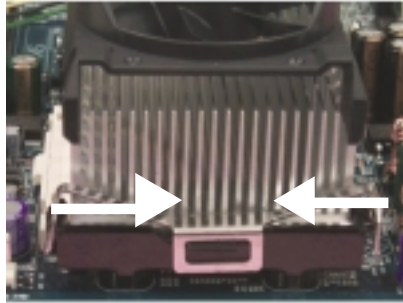
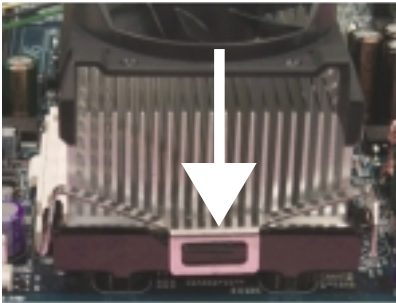

3. Slip the bracket on to the CPU retention and press both end to clip it on the retention.

- Please use Intel approved cooling fan.
- We recommend you to apply the thermal paste to provide better heat conduction between your CPU and heatsink.
- Make sure the CPU fan power cable is plugged in to the CPU fan connector, this completes the installation.
- Please refer to CPU heat sink user's manual for more detail installation procedure.

Step 2: Install memory modules

The motherboard has 4 Rambus In-line Memory Module (RIMM) sockets. The BIOS will automatically detect memory type and size. To install the memory module, just push it vertically into the RIMM Slot. The RIMM module can only fit in one direction due to the two notches. Please note; Both RIMM modules inserted on RIMM1 and RIMM3 slots are recommended to have the same size, frequency. If not, the larger sized module will be automatically re-sized by BIOS to match the smaller sized module. The same rule applies to both RIMM2 and RIMM4 slots.

You can insert two RIMMs or four RIMMs into RIMM slots, but C-RIMM (Continuity RIMM) modules must be inserted into the empty slots.



RIMM



CRIMM

Check RIMM module if it is supported by the M/B.

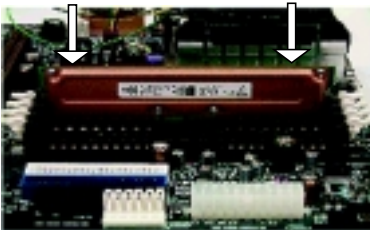

Insert the RIMM module into the slot.



Push the ejector tab towards the RIMM.

- ⚠ When STR/RIMM LED is ON, you do not install / remove RDRAM from socket.
- ⚠ Please note that the DIMM module can only fit in one direction due to the two notches. Wrong orientation will cause improper installation. Please change the insert orientation.

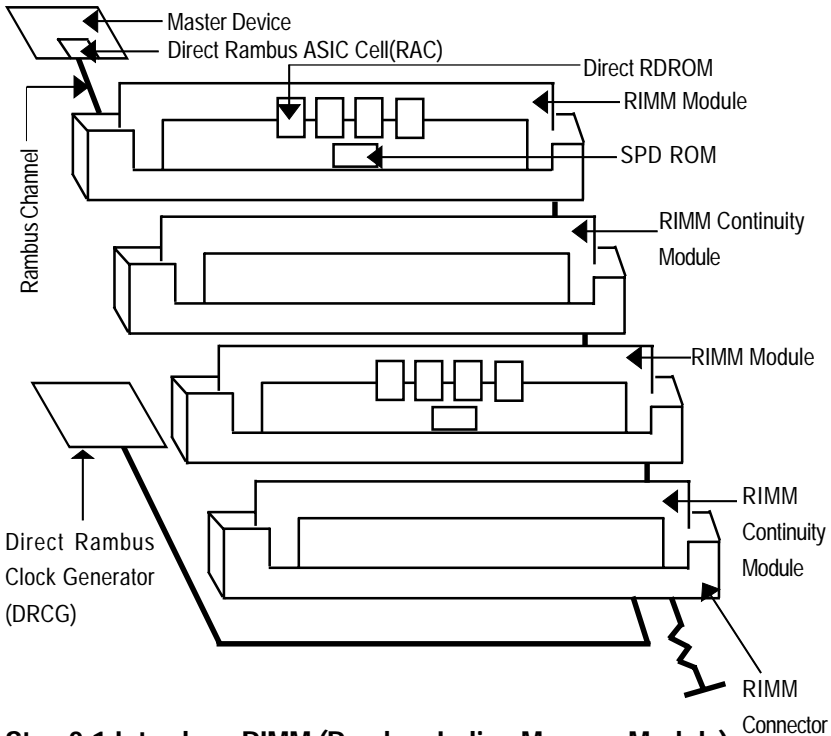

Step 2-1: Introduce RIMM (Rambus In-line Memory Module)

Direct Rambus Memory Controller

⇒ Directly support a Dual Direct Rambus * Channel

- ◆ Supports 300&400 MHz Direct Rambus * Channel @ 100MHz host bus frequency.
- ◆ Maximum memory array size up to 256MB using 64Mb/72Mb, 512MB using 128Mb/144Mb, 1GB using 256Mb/288Mb DRAM technology

⇒ Supports up to 32 Direct Rambus devices per channel

⇒ Supports a maximum DRAM address decode space of 4GB

⇒ Configurable optional ECC operation

- ◆ ECC with single bit Error Correction and multiple bit Error Detection
- ◆ Single bit errors corrected and written back to memory (auto-scrubbing)
- ◆ Parity mode not supported

APIC memory space in hardware. It is the BIOS or system designer's responsibility to limit DRAM population so that adequate PCI, AGP, High BIOS, and APIC memory space can be allocated.

Step 3: Install expansion cards

1. Read the related expansion card's instruction document before install the expansion card into the computer.
2. Remove your computer's chassis cover, necessary screws and slot bracket from the computer.
3. Press the expansion card firmly into expansion slot in motherboard.
4. Be sure the metal contacts on the card are indeed seated in the slot.
5. Replace the screw to secure the slot bracket of the expansion card.
6. Replace your computer's chassis cover.
7. Power on the computer, if necessary, setup BIOS utility of expansion card from BIOS.
8. Install related driver from the operating system.



Step 4: Connect ribbon cables, cabinet wires, and power supply

Step 4-1: I/O shield Introduction

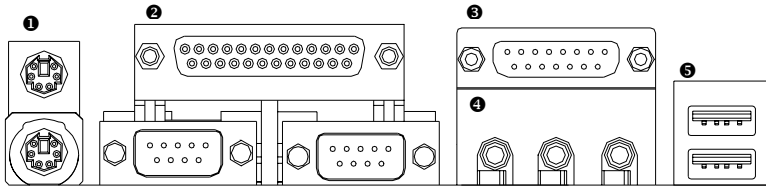

❶ PS/2 Keyboard and PS/2 Mouse Connector

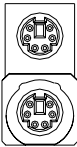

PS/2 Mouse Connector
(6 pin Female)

PS/2 Keyboard Connector
(6 pin Female)

➤ This connector supports standard PS/2 keyboard and PS/2 mouse.

❷ Parallel Port and Serial Ports (COMA/COMB)

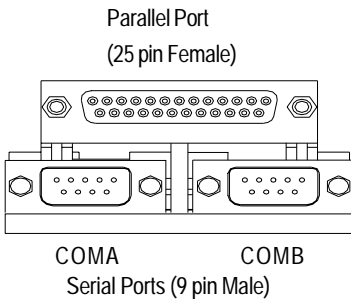

➤ This connector supports 2 standard COM ports and 1 Parallel port. Device like printer can be connected to Parallel port ; mouse and modem etc can be connected to Serial ports.

3 Game /MIDI Ports

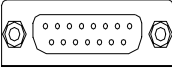

Joystick/ MIDI (15 pin Female)

- This connector supports joystick, MIDI keyboard and other relate audio devices.

4 Audio Connectors

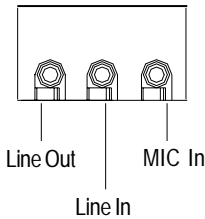

- After install onboard audio driver, you may connect speaker to Line Out jack, micro phone to MIC In jack. Device like CD-ROM , walkman etc can be connected to Line-In jack.

5 USB Connector

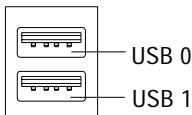

- Before you connect your device(s) into USB connector(s), please make sure your device(s) such as USB keyboard, mouse, scanner, zip, speaker..etc. Have a standard USB interface. Also make sure your OS (Win 95 with USB supplement, Win98, Windows 2000, Windows ME, Win NT with SP 6) supports USB controller. If your OS does not support USB controller, please contact OS vendor for possible patch or driver upgrade. For more information please contact your OS or device(s) vendors.

Step 4-2: Connectors Introduction

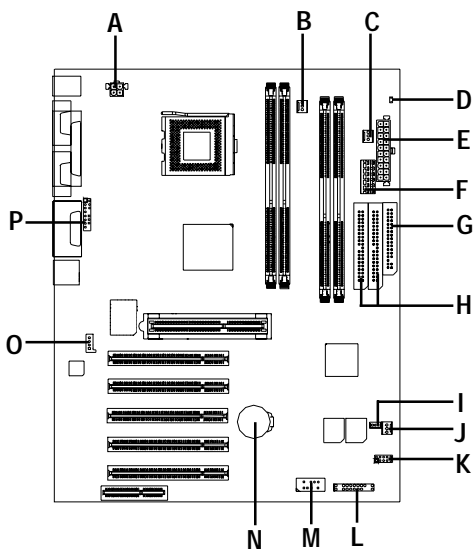

A) J16	I) J7
B) CPU_FAN	J) SYS_FAN
C) PWR_FAN	K) JP15
D) LED2	L) J2
E) J15	M) CN10
F) J18	N) BAT1
G) FLOPPY	O) J2
H) IDE1/IDE2	P) FRONT AUDIO

B) CPU_FAN (CPU FAN Connector)



- Please note, a proper installation of the CPU cooler is essential to prevent the CPU from running under abnormal condition or damaged by overheating. The CPU fan connector supports Max. current up to 600mA .

C) PWR_FAN (Power FAN Connector)



J) SYS_FAN (System FAN Connector)



E) J15 (ATX Power)

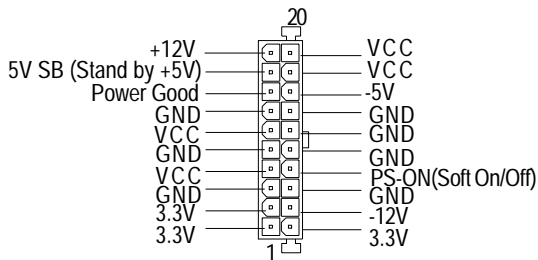

- AC power cord should only be connected to your power supply unit after ATX power cable and other related devices are firmly connected to the mainboard.

F) J18 (AUX Power)

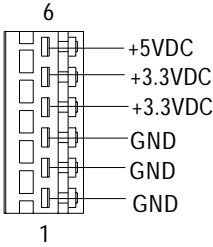

- The 6-pin Aux. Power connector provides additional current to meet the board's +3.3VDC and +5VDC requirements. Please refer to the detail on P.24

A) J16 (AUX +12V Power Connector)

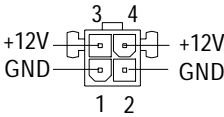

- This connector (ATX +12V) is used only for CPU Core Voltage.

D) LED2 (RIMM LED)



- Do not remove memory modules while RIMM LED is on. It might cause short or other unexpected damages due to the 2.5V stand by voltage. Remove memory modules only when STR function is disabled by jumper and AC Power cord is disconnected.

G) FLOPPY (Floppy Connector)

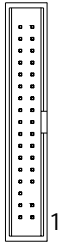

H) IDE1/IDE2 [IDE1 / IDE2 Connector(Primary/Secondary)]

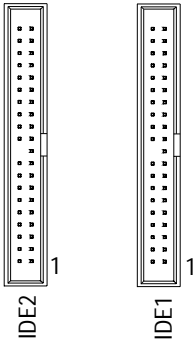

➤ Important Notice:
Please connect first harddisk to IDE1
and connect CDROM to IDE2.

O) J2 (CD Audio Line In)

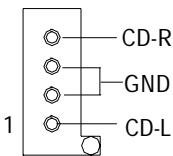

I) J17 (Wake On Lan)

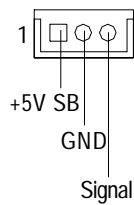

L) J7 (2x11 pins jumper)

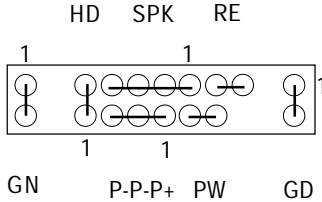

GN (Green Switch)	Open: Normal Operation Close: Entering Green Mode
GD (Green LED)	Pin 1: LED anode(+) Pin 2: LED cathode(-)
HD (IDE Hard Disk Active LED)	Pin 1: LED anode(+) Pin 2: LED cathode(-)
SPK (Speaker Connector)	Pin 1: VCC(+) Pin 2- Pin 3: NC Pin 4: Data(-)
RE (Reset Switch)	Open: Normal Operation Close: Reset Hardware System
P-P-P+(Power LED)	Pin 1: LED anode(+) Pin 2: LED cathode(-) Pin 3: LED cathode(-)
PW (Soft Power Connector)	Open: Normal Operation Close: Power On/Off

- Please connect the power LED, PC speaker, reset switch and power switch etc of your chassis front panel to the front panel jumper according to the pin assignment above.

M) CN10 (Front USB Connector)

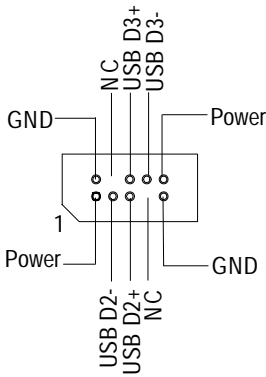

- Be careful with the polarity of the front panel USB connector. Check the pin assignment while you connect the front panel USB cable. Please contact your nearest dealer for optional front panel USB cable.

K) JP15 (IR/CIR)

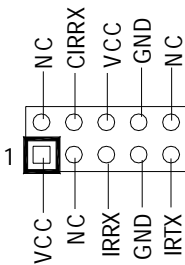

- Make sure the pin 1 on the IR device is aligning with pin one the connector. To enable the IR/CIR function on the board, you are required to purchase an option IR/ CIR module. For detail information please contact your authorized Giga-Byte distributor.

To use IR function only, please connect IR module to Pin1 to Pin5.

P) FRONT AUDIO (Front Audio)

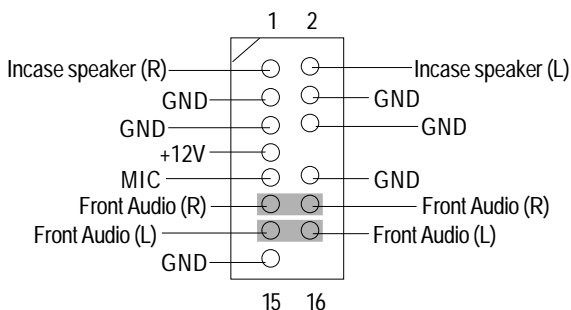

- If you want to use "Front Audio" connector, you must move 11-12,13-14 Jumper. In order to utilize the front audio header, your chassis must have front audio connector. Also please make sure the pin assignment on the cable is the same as the pin assignment on the MB header. To find out if the chassis you are buying support front audio connector, please contact your dealer.

N) BAT1 (Battery)



CAUTION

- ❖ Danger of explosion if battery is incorrectly replaced.
- ❖ Replace only with the same or equivalent type recommended by the manufacturer.
- ❖ Dispose of used batteries according to the manufacturer's instructions.

Step 4-3: ATX 12V Power Supply Introduction

- Additional 4 pin connector for 12V voltage
- Backward compatibility maintained with load sharing capability
- Support 12V or 5V CPU VRs

Check power supply if it is supported by ATX12V Power Supply.

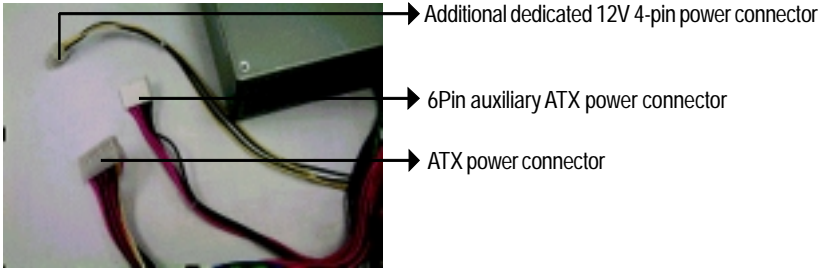

Step 4-4: 6 Pin Aux. Power Connector

Step1: In a 45° angle position, align the tooth of aux. Power cable onto the gird of aux. Power socket.

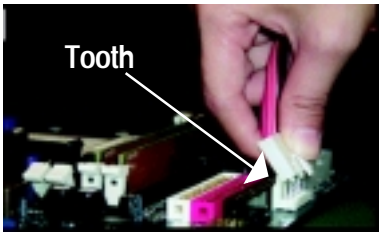

Figure 1

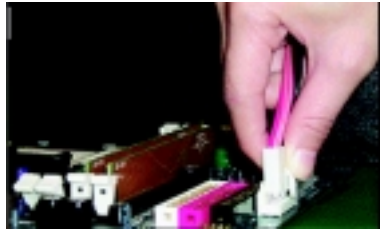

Figure 2

Step3: Properly installed shown below.



Figure 3

Chapter 3 BIOS Setup

BIOS Setup is an overview of the BIOS Setup Program. The program that allows users to modify the basic system configuration. This type of information is stored in battery-backed CMOS RAM so that it retains the Setup information when the power is turned off.

ENTERING SETUP

Press <F8> to enter Boot Menu during POST (Power On Self Test); press <F12> to enter Network boot function, press to enter CMOS Setup.

a. Boot Screen



b. Press <F8> to enter Boot Menu

Select First Boot Device		
Floppy	:	1.44MB 3 ^{1/2}
[Up/Dn] Select	[RETURN] Boot	[ESC] Cnancel

Boot order depends on the devices you use, for example: Floppy, HDD, CD-ROM...

c. Press<F12> to boot from Network.

d. After power on the computer, pressing immediately during POST (Power On Self Test) it will allow you to enter AMI BIOS CMOS SETUP.

CONTROLKEYS

<↑>	Move to previous item
<↓>	Move to next item
<←>	Move to the item in the left hand
<→>	Move to the item in the right hand
<Esc>	Main Menu - Quit and not save changes into CMOS Status Page Setup Menu and Option Page Setup Menu - Exit current page and return to Main Menu
<+/PgUp>	Increase the numeric value or make changes
<-/PgDn>	Decrease the numeric value or make changes
<F1>	General help, only for Status Page Setup Menu and Option Page Setup Menu
<F2>	Reserved
<F3>	Select Language
(Shift)F3	Select Language
<F4>	Reserved
<F5>	Restore the previous CMOS value from CMOS, only for Option Page Setup Menu
<F6>	Load the default CMOS value from BIOS default table, only for Option Page Setup Menu
<F7>	Load the Setup Defaults
<F8>	Flash Utility
<F9>	Reserved
<F10>	Save all the CMOS changes, only for Main Menu

GETTINGHELP

Main Menu

The on-line description of the highlighted setup function is displayed at the bottom of the screen.

Status Page Setup Menu / Option Page Setup Menu

Press F1 to pop up a small help window that describes the appropriate keys to use and the possible selections for the highlighted item. To exit the Help Window press <Esc>.

The Main Menu (For example: BIOS Ver. :F1)

Once you enter AMI BIOS CMOS Setup Utility, the Main Menu (Figure 1) will appear on the screen. The Main Menu allows you to select from eight setup functions and two exit choices. Use arrow keys to select among the items and press <Enter> to accept or enter the sub-menu.

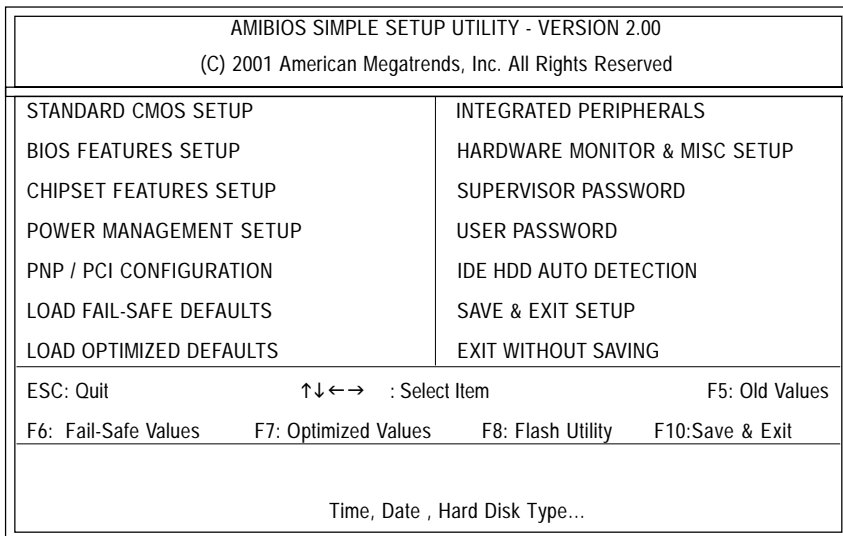

Figure 1: Main Menu

- **Standard CMOS Features**
This setup page includes all the items in standard compatible BIOS.
- **BIOS Features Setup**
This setup page includes all the adjustable items of AMI special enhanced features.
- **Chipset Features Setup**
This setup page includes all the adjustable items of chipset special features.

- **Power Management Setup**

This setup page includes all the adjustable items of Green function features.

- **PNP/PCI Configurations**

This setup page includes all the adjustable configurations of PCI & PnP ISA resources.

- **Load Fail-Safe Defaults**

Load Fail-Safe Defaults option loads preset system parameter values to set the system in its most stable configurations.

- **Load Optimized Defaults**

Load Optimized Defaults option loads preset system parameter values to set the system in its highest performance configurations.

- **Integrated Peripherals**

This setup page includes all onboard peripherals.

- **Hardware Monitor & MISC Setup**

This setup page is auto detect fan and temperature status.

- **Set Supervisor password**

Set Change or disable password. It allows you to limit access to the system and/or BIOS setup.

- **Set User password**

Set Change or disable password. It allows you to limit access to the system.

- **IDE HDD Auto Detection**

Automatically configure hard disk parameters.

- **Save & Exit Setup**

Save CMOS value settings to CMOS and exit setup.

- **Exit Without Saving**

Abandon all CMOS value changes and exit setup.

Standard CMOS Features

AMIBIOS SETUP - STANDARD CMOS SETUP																																									
(C) 2001 American Megatrends, Inc. All Rights Reserved																																									
System Date : Aug 01 2001 Wed																																									
System Time : 14:44:35																																									
<table border="1"> <thead> <tr> <th>TYPE</th> <th>SIZE</th> <th>CYLS</th> <th>HEAD</th> <th>PRECOMP</th> <th>LANDZ</th> <th>SECTOR</th> <th>MODE</th> </tr> </thead> <tbody> <tr> <td>Pri Master</td> <td>: Auto</td> <td></td> <td></td> <td></td> <td></td> <td></td> <td></td> </tr> <tr> <td>Pri Slave</td> <td>: Auto</td> <td></td> <td></td> <td></td> <td></td> <td></td> <td></td> </tr> <tr> <td>Sec Master</td> <td>: Auto</td> <td></td> <td></td> <td></td> <td></td> <td></td> <td></td> </tr> <tr> <td>Sec Slave</td> <td>: Auto</td> <td></td> <td></td> <td></td> <td></td> <td></td> <td></td> </tr> </tbody> </table>		TYPE	SIZE	CYLS	HEAD	PRECOMP	LANDZ	SECTOR	MODE	Pri Master	: Auto							Pri Slave	: Auto							Sec Master	: Auto							Sec Slave	: Auto						
TYPE	SIZE	CYLS	HEAD	PRECOMP	LANDZ	SECTOR	MODE																																		
Pri Master	: Auto																																								
Pri Slave	: Auto																																								
Sec Master	: Auto																																								
Sec Slave	: Auto																																								
Floppy Drive A : 1.44 MB 3 ^{1/2}	Base Memory : 640 Kb																																								
Floppy Drive B : Not Installed	Other Memory : 384 Kb																																								
	Extended Memory : 255 Mb																																								
Virus Protection : Disabled	Total Memory : 256 Mb																																								
Date is standard format	ESC : Exit																																								
Month : Jan - Dec	↑↓ : Select Item																																								
Day : 01- 31	PU / PD / + / - :Modify																																								
Year : 1990 - 2099	(Shift) F2 :Color																																								

Figure 2: Standard CMOS Setup

System Date

The date format is <month>, <day>, <year>, <week>.

- ▶▶ Month The month, Jan. Through Dec.
- ▶▶ Day The day, from 1 to 31 (or the maximum allowed in the month)
- ▶▶ Year The year, from 1990 through 2099
- ▶▶ Week The week, from Sun to Sat, determined by the BIOS and is display only

☞ SystemTime

The times format in <hour> <minute> <second>. The time is calculated base on the 24-hour military-time clock. For example, 1 p.m. is 13:00:00.

☞ Primary Master, Slave / Secondary Master, Slave

The category identifies the types of hard disk from drive C to F that has been installed in the computer. There are two types: auto type, and manual type. Manual type is user-definable; Auto type which will automatically detect HDD type.

Note that the specifications of your drive must match with the drive table. The hard disk will not work properly if you enter improper information for this category.

If you select User Type, related information will be asked to enter to the following items. Enter the information directly from the keyboard and press <Enter>. Such information should be provided in the documentation form your hard disk vendor or the system manufacturer.

▶▶ CYLS.	Number of cylinders
▶▶ HEADS	number of heads
▶▶ PRECOMP	write precomp
▶▶ LANDZONE	Landing zone
▶▶ SECTORS	number of sectors

If a hard disk has not been installed select NONE and press <Enter>.

☞ Floppy Drive A / Drive B

The category identifies the types of floppy disk drive A or drive B that has been installed in the computer.

▶▶ None	No floppy drive installed
▶▶ 360K, 5.25 in.	5.25 inch PC-type standard drive; 360K byte capacity.
▶▶ 1.2M, 5.25 in.	5.25 inch AT-type high-density drive; 1.2M byte capacity (3.5 inch when 3 Mode is Enabled).
▶▶ 720K, 3.5 in.	3.5 inch double-sided drive; 720K byte capacity
▶▶ 1.44M, 3.5 in.	3.5 inch double-sided drive; 1.44M byte capacity.
▶▶ 2.88M, 3.5 in.	3.5 inch double-sided drive; 2.88M byte capacity.

Virus Protection

If it is set to enable, the category will flash on the screen when there is any attempt to write to the boot sector or partition table of the hard disk drive. The system will halt and the following error message will appear in the mean time. You can run anti-virus program to locate the problem.

- ▶▶ Enabled Activate automatically when the system boots up causing a warning message to appear when anything attempts to access the boot sector or hard disk partition table

- ▶▶ Disabled No warning message to appear when anything attempts to access the boot sector or hard disk partition table (Default Value)

Memory

The category is display-only which is determined by POST (Power On Self Test) of the BIOS.

Base Memory

The POST of the BIOS will determine the amount of base (or conventional) memory installed in the system.

The value of the base memory is typically 512 K for systems with 512 K memory installed on the motherboard, or 640 K for systems with 640 K or more memory installed on the motherboard.

Other Memory

This refers to the memory located in the 640 K to 1024 K address space. This is memory that can be used for different applications.

DOS uses this area to load device drivers to keep as much base memory free for application programs. Most use for this area is Shadow RAM.

ExtendedMemory

The BIOS determines how much extended memory is present during the POST.

This is the amount of memory located above 1 MB in the CPU's memory address map.

BIOS Features Setup

AMIBIOS SETUP - BIOS FEATURES SETUP	
(C) 2001 American Megatrends, Inc. All Rights Reserved	
BIOS Flash Protection	: Auto
1st Boot Device	: Floppy
2nd Boot Device	: IDE-0
3rd Boot Device	: CDROM
Floppy Drive Seek	: Disabled
BootUp Num-Lock	: On
Password Check	: Setup
S.M.A.R.T. for Hard Disks	: Disabled
ESC: Quit ↑↓←→: Select Item F1 : Help PU/PD/+/- : Modify F5 : Old Values (Shift)F2: Color F6 : Fail-Safe F7 : Optimized F8: Flash Utility	

Figure 3: BIOS Features Setup

☞ BIOS Flash Protection

This field lets you determine the states that flash BIOS

- ▶▶ Auto BIOS enables flash write access automatically when updating BIOS data/DMI/ESCD. (Default Value)
- ▶▶ Enabled During POST, DMI/ESCD would not be updated. But flash tools can update BIOS always

☞ 1st / 2nd / 3rd Boot device

- ▶▶ Floppy Select your boot device priority by Floppy.
- ▶▶ ARMD-FDD Select your boot device priority by ARMD-FDD.
- ▶▶ ARMD-HDD Select your boot device priority by ARMD-HDD.
- ▶▶ CDROM Select your boot device priority by CDROM.
- ▶▶ SCSI Select your boot device priority by SCSI.
- ▶▶ NETWORK Select your boot device priority by NETWORK.
- ▶▶ BBS-0 Select your boot device priority by BIOS Boot Specification-0.
- ▶▶ BBS-1 Select your boot device priority by BIOS Boot Specification-1.
- ▶▶ BBS-2 Select your boot device priority by BIOS Boot Specification-2.
- ▶▶ BBS-3 Select your boot device priority by BIOS Boot Specification-3.

- ▶▶ USB FDD Select your boot device priority by USB FDD.
- ▶▶ USB CDROM Select your boot device priority by USB CDROM.
- ▶▶ USB HDD Select your boot device priority by USB HDD.
- ▶▶ USB LS120 Select your boot device priority by USB LS120.
- ▶▶ USB ZIP/MO Select your boot device priority by USB ZIP/MO.
- ▶▶ Disabled Disable this function.
- ▶▶ IDE-0-3 Select your boot device priority by IDE-0-3.

☞ Floppy Drive Seek

During POST, BIOS will determine the floppy disk drive installed is 40 or 80 tracks. 360 K type is 40 tracks 720 K, 1.2 M and 1.44 M are all 80 tracks.

- ▶▶ Enabled BIOS searches for floppy disk drive to determine it is 40 or 80 tracks. Note that BIOS can not tell from 720 K, 1.2 M or 1.44 M drive type as they are all 80tracks.
- ▶▶ Disabled BIOS will not search for the type of floppy disk drive by track number. Note that there will not be any warning message if the drive installed is 360 K. (Default value)

☞ Boot Up NumLock

- ▶▶ On Keypad is number keys. (Default value)
- ▶▶ Off Keypad is arrow keys.

☞ Password Check

Please refer to the detail on P.53

- ▶▶ Always The user must enter correct password in order to access the system and/or BIOS Setup.
- ▶▶ Setup The user must enter correct password in order to access BIOS setup utility. (Default Value)

☞ HDDS.M.A.R.T Capability

- ▶▶ Enabled Enable HDD S.M.A.R.T. Capability.
- ▶▶ Disabled Disable HDD S.M.A.R.T. Capability. (Default value)

Chipset Features Setup

AMIBIOS SETUP - CHIPSET FEATURES SETUP	
(C) 2001 American Megatrends, Inc. All Rights Reserved	
Front Side Bus Clock (MHz) : By Hardware	
CPU Frequency Ratio : 15.0x(Safe)	
RDRAM Bus Frequency : Auto	
Over RIMM Voltage : Disabled	
Memory ECC Mode : Disabled	
Graphics Aperture Size : 64MB	
ICH Delayed Transaction : Disabled	
DMA Collection Buffer : Enabled	
	ESC: Quit ↑↓←→: Select Item F1 : Help PU/PD/+/- : Modify F5 : Old Values (Shift)F2: Color F6 : Fail-Safe F7 : Optimized F8: Flash Utility

Figure 4: Chipset Features Setup

☞ Front Side Bus Clock (MHz)

When set to "By Hardware", the FSB clock frequency will be set to 100MHz. You may also set FSB clock by BIOS. For power End-User use only.

- ☞ By Hardware Set Front Side Bus Clock (MHz) to By Hardware. (Default Value)
- ☞ 100.00 Set Front Side Bus Clock (MHz) to 100.00.
- ☞ 103.00 Set Front Side Bus Clock (MHz) to 103.00.
- ☞ 105.00 Set Front Side Bus Clock (MHz) to 105.00.
- ☞ 108.00 Set Front Side Bus Clock (MHz) to 108.00.
- ☞ 110.00 Set Front Side Bus Clock (MHz) to 110.00.
- ☞ 112.00 Set Front Side Bus Clock (MHz) to 112.00.
- ☞ 115.00 Set Front Side Bus Clock (MHz) to 115.00.
- ☞ 118.00 Set Front Side Bus Clock (MHz) to 118.00.
- ☞ 120.00 Set Front Side Bus Clock (MHz) to 120.00.
- ☞ 133.33 Set Front Side Bus Clock (MHz) to 133.33.

CPU Frequency Ratio

- ▶▶ 8.0x, 10.0x~24.0x (Default Value: 15.0x)

RDRAM Bus Frequency

- ▶▶ Auto Set RDRAM Bus Frequency automatically. (Default Value)
- ▶▶ 400MHz Set RDRAM Bus Frequency to 400MHz. (If the current RDRAM is supported)
- ▶▶ 300MHz Set RDRAM Bus Frequency to 300MHz. (If the current RDRAM is supported)

Over RIMM Voltage

- ▶▶ Enabled Enable Over RIMM Voltage.
- ▶▶ Disabled Disable this function. (Default Value)

Memory ECC Mode

- ▶▶ Enabled Enable Memory Data Check ECC Mode.
- ▶▶ Disabled Disable this function. (Default Value)

Graphics Aperture

- ▶▶ 4 MB Display Graphics Aperture Size is 4MB.
- ▶▶ 8 MB Display Graphics Aperture Size is 8MB.
- ▶▶ 16 MB Display Graphics Aperture Size is 16MB.
- ▶▶ 32 MB Display Graphics Aperture Size is 32MB.
- ▶▶ 64 MB Display Graphics Aperture Size is 64MB. (Default Value)
- ▶▶ 128 MB Display Graphics Aperture Size is 128MB.
- ▶▶ 256 MB Display Graphics Aperture Size is 256MB.

ICH Delayed Transaction

- ▶▶ Enabled Enable PCI 2.1 features including release and delayed transaction for the chipset.
- ▶▶ Disabled Disable this function. (Default Value)

DMA Collection Buffer

- ▶▶ Enabled Enable DMA collection buffer for LPC I/F and PC/PCI DMA.(Default Value)
- ▶▶ Disabled Disable this function.

Power Management Setup

AMIBIOS SETUP - POWER MANAGEMENT SETUP		
(C) 2001 American Megatrends, Inc. All Rights Reserved		
ACPI Sleep Type	: S1/POS	PIRQ[B] IRQ Active : Ignore
USB Dev Wakeup From S3	: Disabled	PIRQ[C] IRQ Active : Ignore
Suspend Time Out (Minute)	: Disabled	PIRQ[D] IRQ Active : Ignore
Throttle Slow Clock Ratio	: 50.0%	
Soft-Off by Power Button	: Instant Off	
System After AC Back	: Off	
ModemRingOn/WakeOnLan	: Enabled	
PME Event Wake Up	: Enabled	
Resume by RTC Alarm	: Disabled	
RTC Alarm Date	: Every Day	
RTC Alarm Hour	: 00	
RTC Alarm Minute	: 00	
RTC Alarm Second	: 00	
KB & PS/2 Mouse Access	: Monitor	
FDC/LPT/COM Ports Access	: Monitor	
Pri. Master IDE Access	: Monitor	ESC: Quit ↑ ↓ ← → : Select Item
Pri. Slave IDE Access	: Ignore	F1 : Help PU/PD/+/- : Modify
Sec. Master IDE Access	: Monitor	F5 : Old Values (Shift)F2: Color
Sec. Slave IDE Access	: Ignore	F6 : Fail-Safe
PIRQ[A] IRQ Active	: Ignore	F7 : Optimized F8: Flash Utility

Figure 5: Power Management Setup

☞ **ACPI Sleep Type**

- ▶▶ S1/POS Set ACPI Sleep Type to S1/POS (Power On Suspend). (Default value)
- ▶▶ S3/STR Set ACPI Sleep Type to S3/STR (Suspend To RAM).

☞ **USB Dev Wakeup From S3**

- ▶▶ Enabled Enable USB Device Wakeup From S3.
- ▶▶ Disabled Disable USB Device Wakeup From S3. (Default value)

☞ **Suspend Time Out**

- ▶▶ Disabled Disable the timer to enter suspend mode. (Default Value)
- ▶▶ 1Minute ~ 60 Minute Set the timer to enter suspend mode.

☞ **Throttle Slow Clock Ratio**

- ▶▶ 12.5%/25.0%/37.5%/50.0% (Default Value)/62.5%/75.0%/87.5%

☞ **Soft-off by Power Button**

- ▶▶ Instant off The user press the power button once, he can turn off the system. (Default Value)
- ▶▶ Suspend The user press the power button once, then he can enter suspend mode.

☞ **System after AC Back**

- ▶▶ Off When AC-power back to the system, the system will be in "Off" state. (Default Value)
- ▶▶ On When AC-power back to the system, the system will be in "On" state.
- ▶▶ Last State When AC-power back to the system, the system will return to the Last state before AC-power off.

☞ **ModemRingOn/WakeOnLan**

- ▶▶ Disabled Disable Modem Ring On / Wake On LAN function.
- ▶▶ Enabled The modem ring / LAN wake up will bring the system out of soft-off or suspend state if this option is set "Enabled". (Default Value)

☞ **PME Event Wake up**

- ▶▶ Disabled Disable PME event wake up function.
- ▶▶ Enabled The PME event wake up will bring the system out of soft-off or suspend state if this option is set "Enabled". (Default Value)

☞ **Resume by RTC Alarm**

You can set "Resume by RTC Alarm " item to enabled and key in Data/time to power on system.

- ▶▶ Disabled Disable this function. (Default Value)
- ▶▶ Enabled Enable alarm function to POWER ON system.

If Resume by RTC Alarm is Enabled.

- ▶▶ RTC Alarm Date: Every Day, 1~31
- ▶▶ RTC Alarm Hour: 0~23
- ▶▶ RTC Alarm Minute: 0~59
- ▶▶ RTC Alarm Second: 0~59

☞ **KB & PS/2 Mouse Access**

- ▶▶ Monitor Monitor Keyboard & PS/2 Mouse Access. (Default Value)
- ▶▶ Ignore Ignore Keyboard & PS/2 Mouse Access.

☞ **FDC/LPT/COM Ports Access**

- ▶▶ Monitor Monitor FDC/LPT/COM Ports Access. (Default Value)
- ▶▶ Ignore Ignore FDC/LPT/COM Ports Access.

☞ **Pri. Master IDE Access**

- ▶▶ Monitor Monitor Primary Master IDE Access. (Default Value)
- ▶▶ Ignore Ignore Primary Master IDE Access.

☞ **Pri. slave IDE Access**

- ▶▶ Monitor Monitor Primary slave IDE Access.
- ▶▶ Ignore Ignore Primary slave IDE Access. (Default Value)

☞ **Sec. Master IDE Access**

- ▶▶ Monitor Monitor Secondary Master IDE Access. (Default Value)
- ▶▶ Ignore Ignore Secondary Master IDE Access.

☞ **Sec. slave IDE Access**

- ▶▶ Monitor Monitor Secondary slave IDE Access.
- ▶▶ Ignore Ignore Secondary slave IDE Access.(Default Value)

☞ **PIRQ[A] IRQ Active**

- ▶▶ Monitor Monitor PIRQ[A] IRQ Active.
- ▶▶ Ignore Ignore PIRQ[A] IRQ Active. (Default Value)

☞ **PIRQ[B] IRQ Active**

- ▶▶ Monitor Monitor PIRQ[B] IRQ Active.
- ▶▶ Ignore Ignore PIRQ[B] IRQ Active. (Default Value)

☞ **PIRQ[C] IRQ Active**

- ▶▶ Monitor Monitor PIRQ[C] IRQ Active.
- ▶▶ Ignore Ignore PIRQ[C] IRQ Active. (Default Value)

☞ **PIRQ[D] IRQ Active**

- ▶▶ Monitor Monitor PIRQ[D] IRQ Active.
- ▶▶ Ignore Ignore PIRQ[D] IRQ Active. (Default Value)

PNP/PCI Configuration

AMIBIOS SETUP - PNP/PCI CONFIGURATION	
(C) 2001 American Megatrends, Inc. All Rights Reserved	
VGA Boot From	: AGP
PCI Slot 1/5 IRQ Priority	: Auto
PCI Slot 2 IRQ Priority	: Auto
PCI Slot 3 IRQ Priority	: Auto
PCI Slot 4 IRQ Priority	: Auto
IRQ3	: PCI/PnP
IRQ4	: PCI/PnP
IRQ5	: PCI/PnP
IRQ7	: PCI/PnP
IRQ9	: PCI/PnP
IRQ10	: PCI/PnP
IRQ11	: PCI/PnP
IRQ14	: PCI/PnP
IRQ15	: PCI/PnP
ESC: Quit ↑↓←→: Select Item F1 : Help PU/PD/+/- : Modify F5 : Old Values (Shift)F2: Color F6 : Fail-Safe F7 : Optimized F8: Flash Utility	

Figure 6: PNP/PCI Configuration

☞ VGA Boot From

- ▶▶ AGP Set VGA Boot from AGP VGA Card. (Default Value)
- ▶▶ PCI Set VGA Boot from PCI VGA Card.

☞ **PCI Slot1/5, 2, 3, 4 IRQ Priority**

- ▶▶ Auto The system will reserved a free IRQ for PCI slot 1/5, 2, 3, 4 device.
(Default Value)
- ▶▶ 3 The system will reserved IRQ3 for PCI slot 1/5, 2, 3, 4 device if no legacy ISA device using IRQ3.
- ▶▶ 4 The system will reserved IRQ for PCI slot 1/5, 2, 3, 4 device if no legacy ISA device using IRQ4.
- ▶▶ 5 The system will reserved IRQ5 for PCI slot 1/5, 2, 3, 4 device if no legacy ISA device using IRQ5.
- ▶▶ 7 The system will reserved IRQ7 for PCI slot 1/5, 2, 3, 4 device if no legacy ISA device using IRQ7.
- ▶▶ 9 The system will reserved IRQ9 for PCI slot 1/5, 2, 3, 4 device if no legacy ISA device using IRQ9.
- ▶▶ 10 The system will reserved IRQ10 for PCI slot 1/5, 2, 3, 4 device if no legacy ISA device using IRQ10.
- ▶▶ 11 The system will reserved IRQ11 for PCI slot 1/5, 2, 3, 4 device if no legacy ISA device using IRQ11.

☞ **IRQ (3,4,5,7,9,10,11,14,15)**

- ▶▶ ISA The resource reserved for Legacy ISA device.
- ▶▶ PCI / PnP The resource can be assigned to PCI/ PnP device.

Load Fail-Safe Defaults

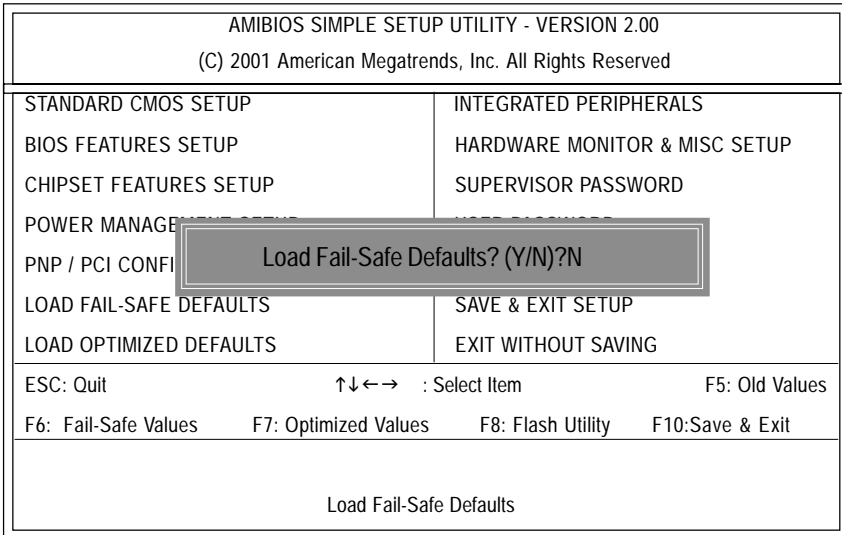

Figure 7: Load Fail-Safe Defaults

Load Fail-Safe Defaults

Fail-Safe defaults contain the most appropriate system parameter values of to configure the system to achieve maximum stability.

Load Optimized Defaults

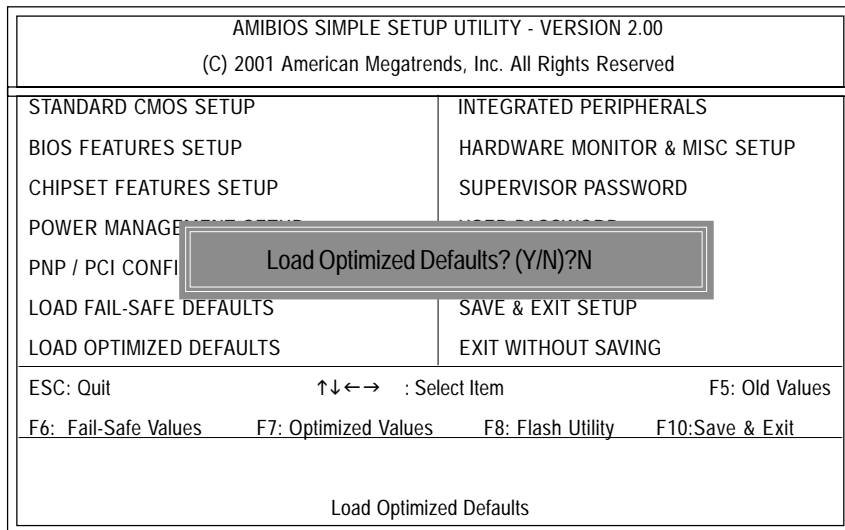

Figure 8: Load Optimized Defaults

Load Optimized Defaults

Optimized defaults contain the most appropriate system parameter values to configure the system to achieve maximum performance.

Integrated Peripherals

AMIBIOS SETUP - INTEGRATED PERIPHERALS			
(C) 2001 American Megatrends, Inc. All Rights Reserved			
OnBoard IDE	: Both	Specific Key for PowerOn	: N/A
IDE1 Conductor Cable	: Auto	USB Function	: Enabled
IDE2 Conductor Cable	: Auto	USB Legacy Support	: Disabled
OnBoard FDC	: Auto	AC97 Audio	: Auto
OnBoard Serial Port A	: Auto	AC97 Modem	: Auto
OnBoard Serial Port B	: Auto		
Serial Port B Mode	: Normal		
IR Duplex Mode	: Half Duplex		
OnBoard CIR Port	: Disabled		
CIR IRQ Select	: 10		
OnBoard Parallel Port	: Auto		
Parallel Port Mode	: ECP		
EPP Version	: N/A		
Parallel Port IRQ	: Auto		
Parallel Port DMA	: Auto		
OnBoard Midi Port	: Disabled	ESC: Quit	↑↓←→: Select Item
Midi IRQ Select	: 10	F1 : Help	PU/PD/+/- : Modify
OnBoard Game Port	: 200	F5 : Old Values	(Shift)F2: Color
Mouse PowerOn Function	: Disabled	F6 : Fail-Safe	
Keyboard PowerOn Function	: Disabled	F7 : Optimized	F8: Flash Utility

Figure 9: Integrated Peripherals

☞ **OnBoard IDE**

- ▶▶ Disabled Disable OnBoard IDE.
- ▶▶ Both Both Primary & Secondary IDE channel will be enabled. (Default Value)
- ▶▶ Primary Only Primary IDE channel is enabled.
- ▶▶ Secondary Only Secondary IDE channel is enabled.

☞ **IDE1 Conductor Cable**

- ▶▶ Auto Will be automatically detected by BIOS. (Default Value)
- ▶▶ ATA66/100 Set IDE1 Conductor Cable to ATA66/100 (Please make sure your IDE device and cable is compatible with ATA66/100).
- ▶▶ ATA33 Set IDE1 Conductor Cable to ATA33 (Please make sure your IDE device and cable is compatible with ATA33).

☞ **IDE2 Conductor Cable**

- ▶▶ Auto Will be automatically detected by BIOS. (Default Value)
- ▶▶ ATA66/100 Set IDE2 Conductor Cable to ATA66/100 (Please make sure your IDE device and cable is compatible with ATA66/100).
- ▶▶ ATA33 Set IDE2 Conductor Cable to ATA33 (Please make sure your IDE device and cable is compatible with ATA33).

☞ **OnBoard FDC**

- ▶▶ Disabled Disable this function.
- ▶▶ Enabled Enable on board floppy disk controller.
- ▶▶ Auto Set the floppy disk controller automatically. (Default Value)

☞ **Onboard Serial Port A**

- ▶▶ Auto BIOS will automatically setup the port A address. (Default Value)
- ▶▶ 3F8/COM1 Enable onboard Serial port A and address is 3F8.
- ▶▶ 2F8/COM2 Enable onboard Serial port A and address is 2F8.
- ▶▶ 3E8/COM3 Enable onboard Serial port A and address is 3E8.
- ▶▶ 2E8/COM4 Enable onboard Serial port A and address is 2E8.
- ▶▶ Disabled Disable onboard Serial port A.

☞ Onboard Serial Port B

- ▶▶ Auto BIOS will automatically setup the port B address. (Default Value)
- ▶▶ 3F8/COM1 Enable onboard Serial port B and address is 3F8.
- ▶▶ 2F8/COM2 Enable onboard Serial port B and address is 2F8.
- ▶▶ 3E8/COM3 Enable onboard Serial port B and address is 3E8.
- ▶▶ 2E8/COM4 Enable onboard Serial port B and address is 2E8.
- ▶▶ Disabled Disable onboard Serial port B.

☞ Serial Port B Mode

(This item allows you to determine which Infra Red(IR) function of Onboard I/O chip)

- ▶▶ ASKIR Set onboard I/O chip UART to ASKIR Mode.
- ▶▶ IrDa Set onboard I/O chip UART to IrDa Mode.
- ▶▶ Normal Set onboard I/O chip UART to Normal Mode. (Default Value)

☞ IR Duplex Mode

- ▶▶ Half Duplex IR Function Duplex Half. (Default Value)
- ▶▶ Full Duplex IR Function Duplex Full.

☞ OnBoard CIR Port

- ▶▶ Disabled Disable this function. (Default Value)
- ▶▶ Enabled Enable Onboard CIR port.

☞ CIR IRQ Select

- ▶▶ IRQ 3 / 4 / 9 / 10 (Default Value) / 11

☞ Onboard Parallel Port

- ▶▶ 378 Set On Board LPT port and address to 378.
- ▶▶ 278 Set On Board LPT port and address to 278.
- ▶▶ 3BC Set On Board LPT port and address to 3BC.
- ▶▶ Auto Set On Board LPT port Automatically. (Default Value)
- ▶▶ Disabled Disable onboard Serial port A.

☞ **Parallel Port Mode**

- ▶▶ EPP Using Parallel port as Enhanced Parallel Port.
- ▶▶ ECP Using Parallel port as Extended Capabilities Port. (Default Value)
- ▶▶ Normal Normal Operation.

☞ **EPP Version**

- ▶▶ N/A Disable this function. (Default Value)
- ▶▶ 1.9 Compliant with EPP 1.9 version.
- ▶▶ 1.7 Compliant with EPP 1.7 version.

☞ **Parallel Port IRQ**

- ▶▶ 7 Set Parallel Port IRQ to 7.
- ▶▶ 5 Set Parallel Port IRQ to 5.
- ▶▶ Auto Set Parallel Port IRQ automatically. (Default Value)

☞ **Parallel Port DMA**

- ▶▶ 3 Set Parallel Port DMA to 3.
- ▶▶ 1 Set Parallel Port DMA to 1.
- ▶▶ 0 Set Parallel Port DMA to 0.
- ▶▶ Auto Set Parallel Port DMA automatically. (Default Value)

☞ **OnBoard Midi Port**

- ▶▶ Disabled Disable onboard Midi Port. (Default Value)
- ▶▶ 300 Set onboard Midi Port to 300.
- ▶▶ 330 Set onboard Midi Port to 330.
- ▶▶ 292 Set onboard Midi Port to 292.
- ▶▶ 290 Set onboard Midi Port to 290.

☞ **Midi IRQ Select**

- ▶▶ IRQ 5 / 7 / 9 / 10 (Default Value)

☞ OnBoard Game Port

- ▶▶ Disabled Disable OnBoard Game Port.
- ▶▶ 200 Set OnBoard Game Port to 200. (Default Value)
- ▶▶ 208 Set OnBoard Game Port to 208.

☞ Mouse PowerOn Function

- ▶▶ Disabled Disable this function. (Default Value)
- ▶▶ Right -button Click right-button to power on the system.
- ▶▶ Left-button Click Left-button to power on the system.

☞ Keyboard PowerOn Function

- ▶▶ Disabled Disable this function. (Default Value)
- ▶▶ Specific key Set password key to power on by keyboard.
- ▶▶ Power Key Set "Power key" to power on the system.

☞ Specific Key for PowerOn

- ▶▶ N/A Disable this function. (Default Value)
- ▶▶ Password ↵ Input password (from 1 to 5 characters) and press Enter to set the Key board Power On Password.

☞ USB Function

- ▶▶ Enabled Enable USB Function. (Default Value)
- ▶▶ Disabled Disable this function.

☞ USB Legacy Support

- ▶▶ Enabled Enable USB Legacy Support.
- ▶▶ Disabled Disable this function.(Default Value)

☞ **AC97 Audio**

- ▶▶ Auto Enable onboard AC'97 audio function. (Default Value)
- ▶▶ Disabled Disable this function.

☞ **AC97 Modem**

- ▶▶ Auto BIOS will search MC97 Codec (AMR Modem Card). If found, MC97 function will be enabled. If no MC97 Codec found, MC97 function will be disabled. (Default Value)
- ▶▶ Disabled Disable this function.

Hardware Monitor & MISC Setup

AMIBIOS SETUP - HARDWARE MONITOR & MISC SETUP		
(C) 2001 American Megatrends, Inc. All Rights Reserved		
CPU Temp. Alarm	:Disabled	
CPU Fan Fail Alarm	:No	
Power Fan Fail Alarm	:No	
System Fan Fail Alarm	:No	
Reset Case Open Status	:No	
Case Status	:Closed	
Current CPU Temp.	: 35°C/ 95°F	
Current System Temp.	: 33°C/ 91°F	
Current CPU Fan Speed	: 5273 RPM	
Current System Fan Speed	: 0 RPM	
Current Power Fan Speed	: 0 RPM	
CPU VID	: 1.700 V	
Vcore	: +1.632V	
Vcc18	: +1.840V	
Vio	: +3.344V	ESC: Quit ↑↓←→: Select Item
+5.000V	: +5.080V	F1 : Help PU/PD/+/- : Modify
+12.000V	: +11.840V	F5 : Old Values (Shift)F2: Color
Battery	: +3.020V	F6 : Fail-Safe
+5V SB	: +4.972V	F7 : Optimized F8: Flash Utility

Figure 10: Hardware Monitor & MISC Setup

CPU Temp. Alarm

- ▶▶ 60°C / 140°F Monitor CPU Temp. at 60°C / 140°F.
- ▶▶ 70°C / 158°F Monitor CPU Temp. at 70°C / 158°F.
- ▶▶ 80°C / 176°F Monitor CPU Temp. at 80°C / 176°F.
- ▶▶ 90°C / 194°F Monitor CPU Temp. at 90°C / 194°F.
- ▶▶ Disabled Disable this function. (Default Value)

☞ **Fan Fail Alarm**

CPU / Power / System

- ▶▶ No Fan Fail Alarm Function Disable. (Default Value)
- ▶▶ Yes Fan Fail Alarm Function Enable.

☞ **Reset Case Open Status**

☞ **Case Status**

- ▶▶ If the case is closed, "Case Opened" will show "No".
- ▶▶ If the case have been opened, "Case Opened" will show "Yes".
- ▶▶ If you want to reset "Case Opened" value, set "Reset Case Open Status" to "Enabled" and save CMOS, your computer will restart.

☞ **Current CPU Temp.**

- ▶▶ Detect CPU Temp. automatically.

☞ **Current System Temp.**

- ▶▶ Detect System Temp. automatically.

☞ **Current CPU Fan / System Fan / Power Fan Speed (RPM)**

- ▶▶ Detect Fan speed status automatically.

☞ **Current CPU VID / Vcore / Vcc18 / Vio / +12 / +5V / Battery / +5VSB**

- ▶▶ Detect system's voltage status automatically.

IDE HDD Auto Detection

AMIBIOS SETUP - STANDARD CMOS SETUP																																									
(C) 2001 American Megatrends, Inc. All Rights Reserved																																									
System Date: Aug 01 2001 Wed																																									
System Time: 14:44:35																																									
<table border="1"> <thead> <tr> <th>TYPE</th> <th>SIZE</th> <th>CYLS</th> <th>HEAD</th> <th>PRECOMP</th> <th>LANDZ</th> <th>SECTOR</th> <th>MODE</th> </tr> </thead> <tbody> <tr> <td>Pri Master</td> <td>: Auto</td> <td></td> <td></td> <td></td> <td></td> <td></td> <td></td> </tr> <tr> <td>Pri Slave</td> <td>: Auto</td> <td></td> <td></td> <td></td> <td></td> <td></td> <td></td> </tr> <tr> <td>Sec Master</td> <td>: Auto</td> <td></td> <td></td> <td></td> <td></td> <td></td> <td></td> </tr> <tr> <td>Sec Slave</td> <td>: Auto</td> <td></td> <td></td> <td></td> <td></td> <td></td> <td></td> </tr> </tbody> </table>		TYPE	SIZE	CYLS	HEAD	PRECOMP	LANDZ	SECTOR	MODE	Pri Master	: Auto							Pri Slave	: Auto							Sec Master	: Auto							Sec Slave	: Auto						
TYPE	SIZE	CYLS	HEAD	PRECOMP	LANDZ	SECTOR	MODE																																		
Pri Master	: Auto																																								
Pri Slave	: Auto																																								
Sec Master	: Auto																																								
Sec Slave	: Auto																																								
Floppy Drive A : 1.44 MB 3 ^{1/2}	Base Memory : 640 Kb																																								
Floppy Drive B : Not Installed	Other Memory : 384 Kb																																								
Virus Protection : Disabled	Extended Memory : 255 Mb																																								
	Total Memory : 256 Mb																																								
Date is standard format	ESC : Exit																																								
Month : Jan - Dec	↑↓ : Select Item																																								
Day : 01- 31	PU / PD / + / - :Modify																																								
Year : 1990 - 2099	(Shift) F2 : Color																																								

Figure 12: IDE HDD Auto Detection

Type "Y" will accept the H.D.D. parameter reported by BIOS.

Type "N" will keep the old H.D.D. parameter setup. If the hard disk cylinder number is over 1024, then the user can select LBA mode or LARGER mode for DOS partition larger than 528 MB.

Exit Without Saving

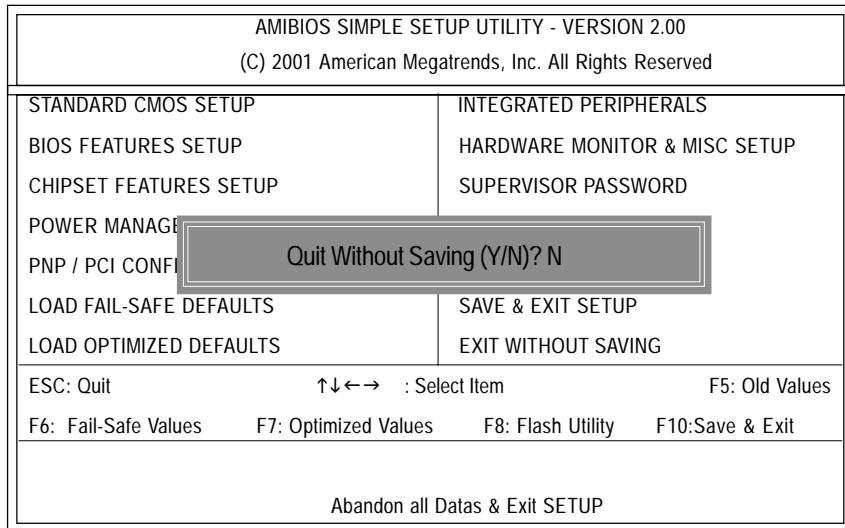

Figure 14: Exit Without Saving

Type "Y" will quit the Setup Utility without saving to RTC CMOS.

Type "N" will return to Setup Utility.

Chapter 4 Technical Reference

Performance List

The following performance data list is the testing results of some popular benchmark testing programs. These data are just referred by users, and there is no responsibility for different testing data values gotten by users. (The different Hardware & Software configuration will result in different benchmark testing results.)

CPU	Intel Pentium® 4 2GHz processor
DRAM	(128 x 2) MB RAM (SAMSUNG MR16R0828AN1-CK7)
CACHE SIZE	256KB included in CPU
DISPLAY	Gigabyte GV-GF3000D
STORAGE	Onboard IDE (Quantum AS30000AT 30GB)
O.S	Windows 2000+ SP2
DRIVER	Display Driver at 1024 x 768 x 64K colors x 75Hz. IUCD ver. 1.81 For Intel chipset M.B.

Processor	Intel Pentium® 4 2GHz (100x20)
------------------	--------------------------------

WCPUID 3.0C Clock Frequency	
Internal MHz	2008.88
External MHz	100.44

SiSoft Sandra 2001	
CPU/FPU Benchmark	3900/(1046/2450)
CPU Multi-Media Benchmark	7970/9856
Drives Benchmark	20759
Memory Benchmark	1406/1460

SPECviewperf 6.12	
Pro CDRS-03	14.97
MedMCAD-01	25.92
Light-04	4.048
DX-06	13.43
DRV-07	17.45
Awadvs-04	49.18

QUAKE III Arena	
640*480*16 Demo1	236.2
1024*768*32 Demo2	179.0

3D Mark 2001 1.0	5962
-------------------------	------

Load BIOS From Floppy

 In the A:drive, insert the "BIOS" diskette, then Press Enter to Run.

 Input BIOS file name in the text box. Press "Enter".

LoadXXXX.XX



Where XXX.XX is name of the BIOS file.

Are you sure to COPY BIOS?
[Enter] to Continue Or [Esc] to abort..

!! COPY BIOS Completed -Pass !!
Please press any key to continue

Congratulation! You have completed the flashed and now can restart system.

@ BIOS Introduction

Gigabyte announces @ BIOS

Windows BIOS live update utility



Have you ever updated BIOS by yourself? Or like many other people, you just know what BIOS is, but always hesitate to update it? Because you think updating newest BIOS is unnecessary and actually you don't know how to update it.

Maybe not like others, you are very experienced in BIOS updating and spend quite a lot of time to do it. But of course you don't like to do it too much. First, download different BIOS from website and then switch the operating system to DOS mode. Secondly, use different flash utility to update BIOS. The above process is not a interesting job. Besides, always be carefully to store the BIOS source code correctly in your disks as if you update the wrong BIOS, it will be a nightmare.

Certainly, you wonder why motherboard vendors could not just do something right to save your time and effort and save you from the lousy BIOS updating work? Here it comes! Now Gigabyte announces @BIOS—the first Windows BIOS live update utility. This is a smart BIOS update software. It could help you to download the BIOS from internet and update it. Not like the other BIOS update software, it's a Windows utility. With the help of "@BIOS", BIOS updating is no more than a click.

Besides, no matter which mainboard you are using, if it's a Gigabyte's product*, @BIOS help you to maintain the BIOS. This utility could detect your correct mainboard model and help you to choose the BIOS accordingly. It then downloads the BIOS from the nearest Gigabyte ftp site automatically. There are several different choices; you could use "Internet Update" to download and update your BIOS directly. Or you may want to keep a backup for your current BIOS, just choose "Save Current BIOS" to save it first. You make a wise choice to use Gigabyte, and @BIOS update your BIOS smartly. You are now worry free from updating wrong BIOS, and capable to maintain and manage your BIOS easily. Again, Gigabyte's innovative product erects a milestone in mainboard industries.

For such a wonderful software, how much it costs? Impossible! It's free! Now, if you buy a Gigabyte's motherboard, you could find this amazing software in the attached driver CD. But please remember, connected to internet at first, then you could have a internet BIOS update from your Gigabyte @BIOS.

Easy TuneIII™ Introduction

Gigabyte announces *EasyTuneIII* Windows overdrive utility



“Overdrive” might be one of the most common issues in computer field. But have many users ever tried it? The answer is probably “no”. Because “overdrive” is thought to be very difficult and includes a lot of technical know-how, sometimes “overdrive” is even considered as special skills found only in some enthusiasts.

But as to the experts in “overdrive”, what’s the truth? They may spend quite a lot of time and money to study, try and use many different hardware and software tools to do “overdrive”. And even with these technologies, they still learn that it’s quite a risk because the safety and stability of an “overdrive” system is unknown.

Now everything is different because of a Windows overdrive utility EasyTuneIII—announced by Gigabyte. This utility has totally changed the gaming rule of “overdrive”. This is the first overdrive utility suitable for both normal and power users. Users can choose either “Easy Mode” or “Advanced Mode” to run “overdrive” at their convenience. For users who choose “Easy Mode”, they just need to click “Auto Optimize” to have auto and immediate CPU overclocking. This software will then overdrive CPU speed automatically with the result being shown in the control panel. If someone prefers to “overdrive” by oneself, there is also another choice. Click “Advanced Mode” to enjoy “sport drive” class overclocking. In “Advanced Mode”, one can change the system bus speed in small increments to get ultimate system performance. And no matter which mainboard is used, if it’s a Gigabyte’s product”, EasyTuneIII helps to perform the best of system.

Besides, different from other traditional over-clocking methods, EasyTuneIII doesn’t require users to change neither BIOS nor hardware switch/jumper setting; on the other hand, they can do “overdrive” at only one click. Therefore, this is a safer way for “overdrive” as nothing is changed on software or hardware. If user runs EasyTuneIII over system’s limitation, the biggest lost is only to restart the computer again and the side effect is then well controlled. Moreover, if one well-performed system speed been tested in EasyTuneIII, user can “Save” this bus speed and “Load” it in next time. Obviously, Gigabyte EasyTuneIII has already turned the “overdrive” technology toward to a newer generation.

This wonderful software is now free bundled in Gigabyte motherboard attached driver CD. Users may make a test drive of “EasyTuneIII” to find out more amazing features by themselves.

Chapter 5 Appendix

Picture below are shown in Windows ME (UCD driver version 1.81)

Appendix A: Intel 850 Chipset Driver Installation

A. Windows 9x/ME/2000/XP INF Update Utility:

Insert the driver CD-title that came with your motherboard into your CD-ROM driver, the driver CD-title will auto start and show the installation guide. If not, please double click the CD-ROM device icon in "My computer", and execute the setup.exe.

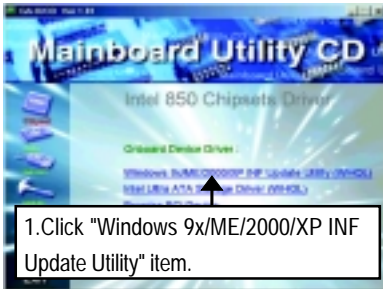

(1)

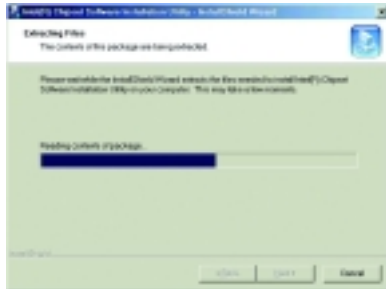

(2)

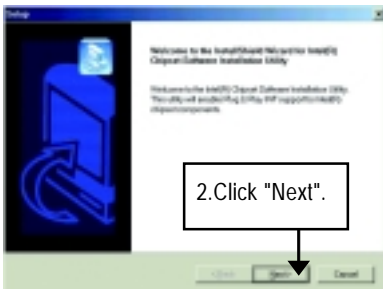

(3)

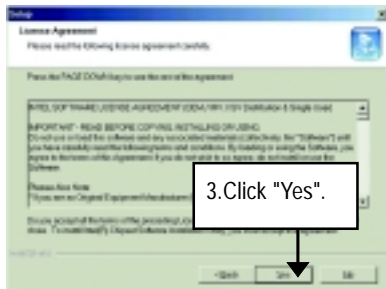

(4)

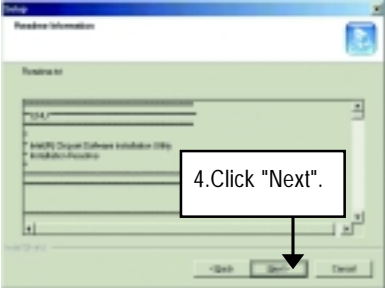

(5)

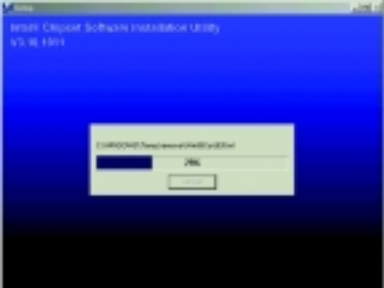

(6)



(7)

B. Intel Ultra ATA Storage Driver:

Insert the driver CD-title that came with your motherboard into your CD-ROM driver, the driver CD-title will auto start and show the installation guide. If not, please double click the CD-ROM device icon in "My computer", and execute the setup.exe.



(1)



(2)

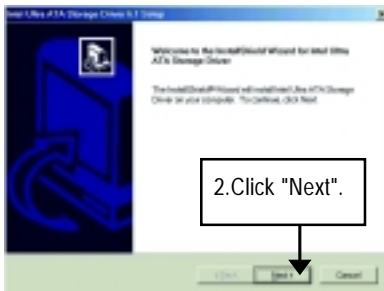

(3)

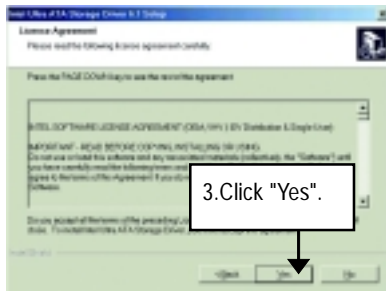

(4)

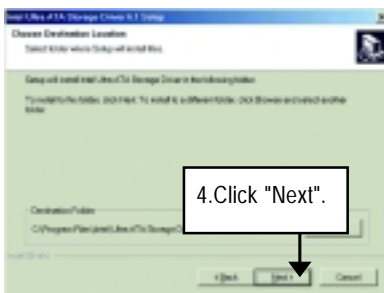

(5)

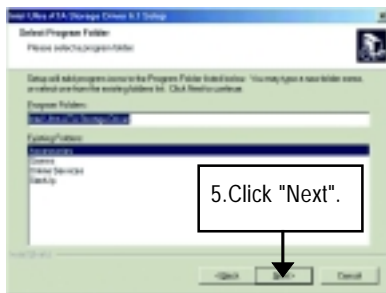

(6)

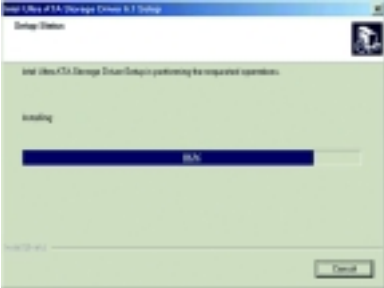

(7)

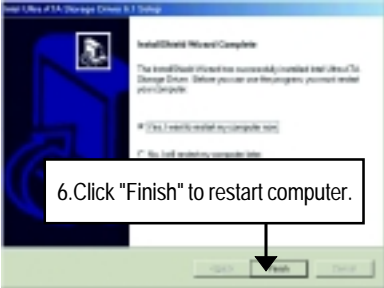

(8)

Appendix B: RealTek AC'97 Audio Driver

Insert the driver CD-title that came with your motherboard into your CD-ROM driver, the driver CD-title will auto start and show the installation guide. If not, please double click the CD-ROM device icon in "My computer", and execute the setup.exe.

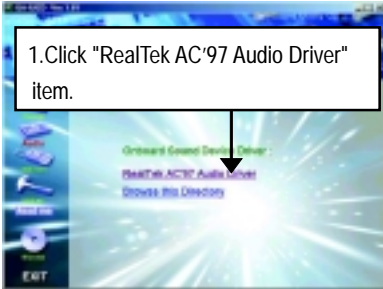

(1)



(2)

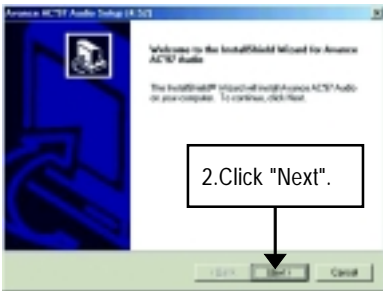

(3)

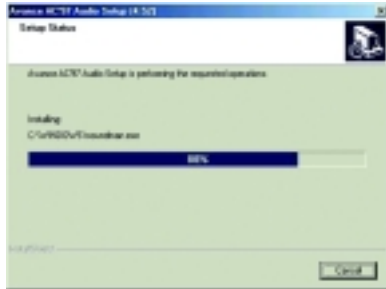

(4)

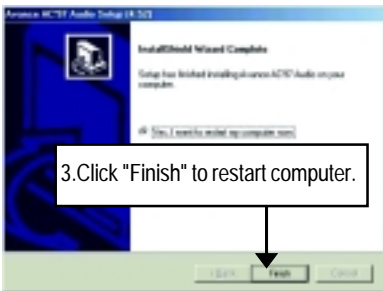

(5)

Appendix C: EasyTuneIII Utilities Installation

Insert the driver CD-title that came with your motherboard into your CD-ROM driver, the driver CD-title will auto start and show the installation guide. If not, please double click the CD-ROM device icon in "My computer", and execute the setup.exe.

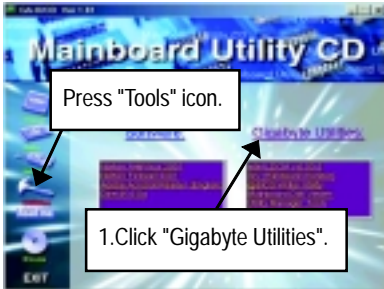

(1)



(2)

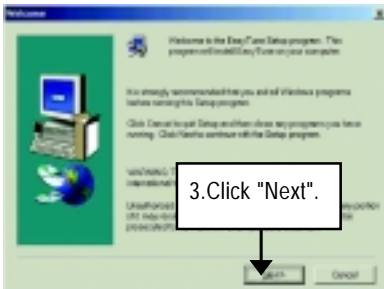
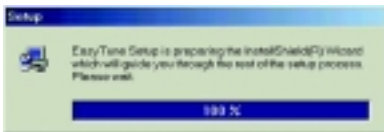

(3)

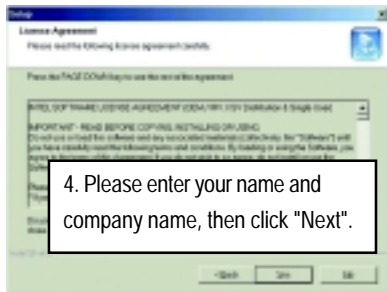

(4)

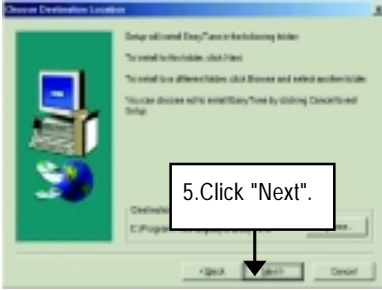

(5)



(6)

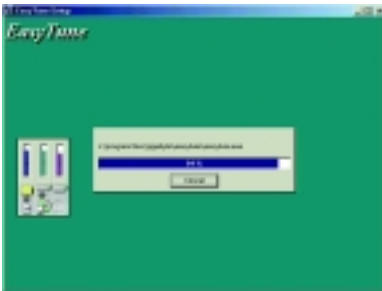

(7)

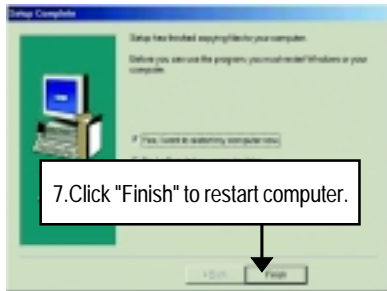

(8)

Appendix D: Issues To Beware Of When Installing CNR

Please use standard CNR card like the one in order to avoid mechanical problem. (See Figure A)

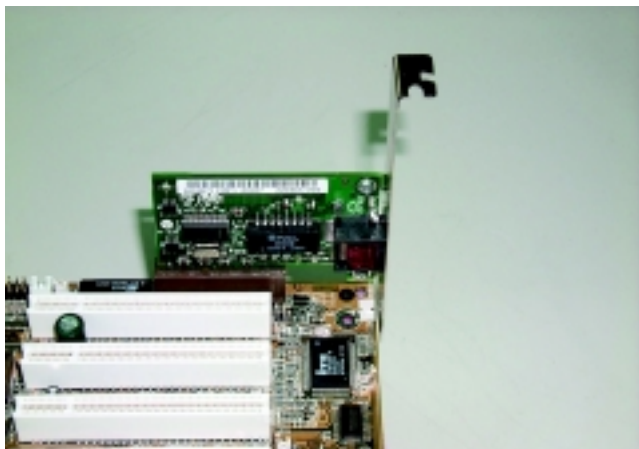
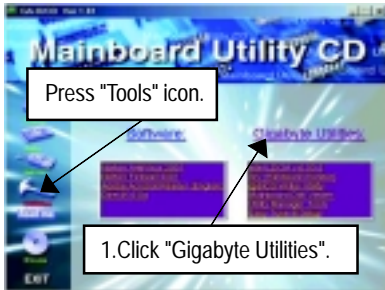

Figure A: Standard CNR Card

Appendix E: BIOS Flash Procedure

BIOS update procedure:

If your OS is Win9X, we recommend that you used Gigabyte @BIOS™ Program to flash BIOS.



(1)

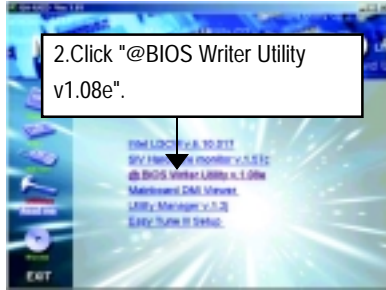

(2)

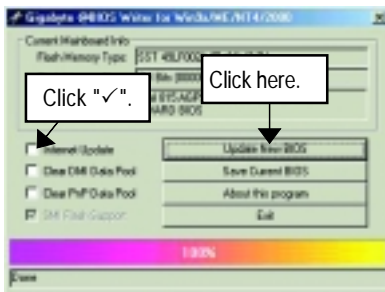

(3)

Methods and steps:

- I. Update BIOS through Internet
 - a. Click "Internet Update" icon
 - b. Click "Update New BIOS" icon
 - c. Select @BIOS™ sever ("Gigabyte @BIOSTM sever 1 in Taiwan" and "Gigabyte @BIOS™ sever 2 in Taiwan" are available for now, the others will be completed soon)
 - d. Select the exact model name on your motherboard
 - e. System will automatically download and update the BIOS.

II. Update BIOS NOT through Internet:

- a. Do not click "Internet Update" icon
- b. Click "Update New BIOS"
- c. Please select "All Files" in dialog box while opening the old file.
- d. Please search for BIOS unzip file, downloading from internet or any other methods (such as: 8ITXE.F1).
- e. Complete update process following the instruction.

III. Save BIOS

In the very beginning, there is "Save Current BIOS" icon shown in dialog box. It means to save the current BIOS version.

IV. Check out supported motherboard and Flash ROM:

In the very beginning, there is "About this program" icon shown in dialog box. It can help you check out which kind of motherboard and which brand of Flash ROM are supported.

Note:

- a. In method I, if it shows two or more motherboard's model names to be selected, please make sure your motherboard's model name again. Selecting wrong model name will cause the system unbooted.
- b. In method II, be sure that motherboard's model name in BIOS unzip file are the same as your motherboard's. Otherwise, your system won't boot.
- c. In method I, if the BIOS file you need cannot be found in @BIOS™ server, please go onto Gigabyte's web site for downloading and updating it according to method II.
- d. Please note that any interruption during updating will cause system unbooted

We use GA-7VTX motherboard and Flash841 BIOS flash utility as example.

Please flash the BIOS according to the following procedures if you are now under the DOS mode.

Flash BIOS Procedure:

STEP 1:

- (1) Please make sure you have set "Auto" for BIOS Feature Setup (BIOS Flash Protection). For more detail please refer to page 32.
- (2) Please make sure your system has installed the extraction utility such as winzip or pkunzip.
Firstly you have to install the extraction utility such as winzip or pkunzip for unzip the files. Both of these utilities are available on many shareware download pages like <http://www.shareware.cnet.com>

STEP 2: Make a DOS boot diskette. (See example: Windows 98 O.S.)

Beware: Windows ME/2000 are not allowed to make a DOS boot diskette.

- (1) With an available floppy disk in the floppy drive. Please leave the diskette "UN-write protected" type. Double click the "My Computer" icon from Desktop, then click "3.5 diskette (A)" and right click to select "Format (M)"

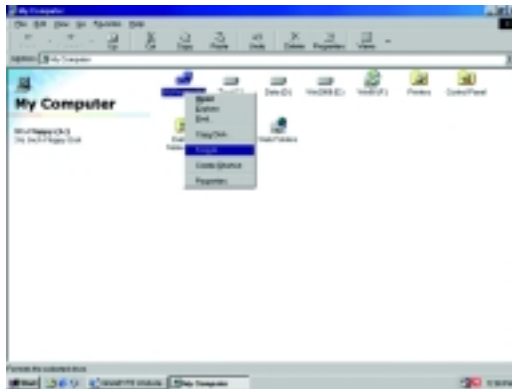

- (2) Select the "Quick (erase)" for Format Type, and pick both "Display summary when finished" and "Copy system files", after that press "Start". That will format the floppy and transfer the needed system files to it.

Beware: This procedure will erase all the prior data on that floppy, so please proceed accordingly.

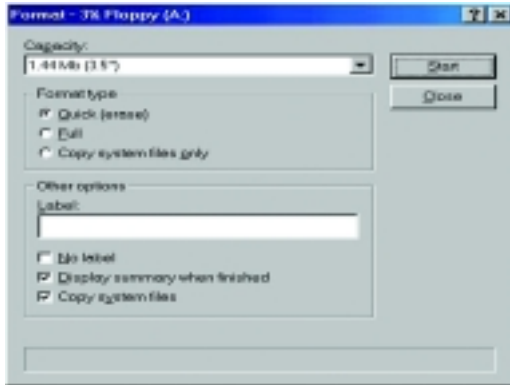

- (3) After the floppy has been formatted completely, please press "Close".



STEP 3: Download BIOS and BIOS utility program.

(1) Please go to Gigabyte website <http://www.gigabyte.com.tw/index.html>, and click "Support".



(2) From Support zone, click the "Motherboards BIOS & Drivers".

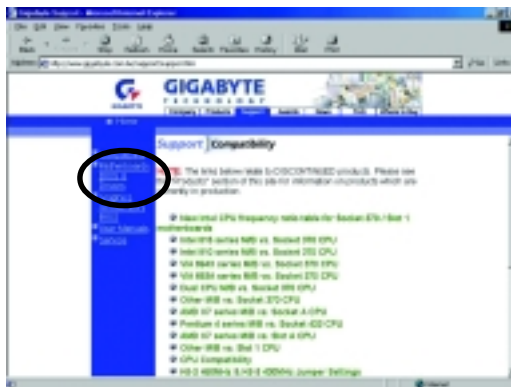

- (3) We use GA-7VTX motherboard as example. Please select GA-7VTX by Model or Chipset optional menu to obtain BIOS flash files.

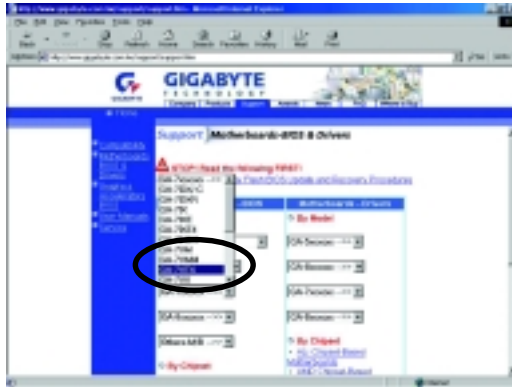

- (4) Select an appropriate BIOS version (For example: F4), and click to download the file. It will pop up a file download screen, then select the "Open this file from its current location" and press "OK".

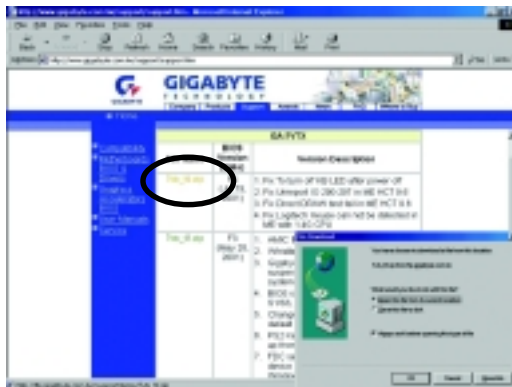

- (5) At this time the screen shows the following picture, please click "Extract" button to unzip the files.

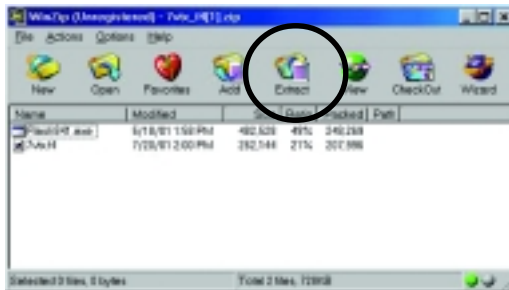

- (6) Please extract the download files into the clean bootable floppy disk A mentioned in STEP 2, and press "Extract".

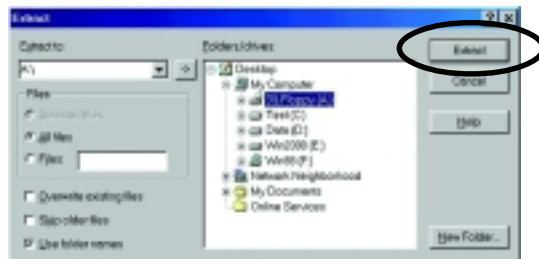

STEP 4: Make sure the system will boot from the floppy disk.

- (1) Insert the floppy disk (contains bootable program and unzip file) into the floppy drive A. Then, restart the system. The system will boot from the floppy disk. Please press key to enter BIOS setup main menu when system is boot up.



- (2) Once you enter the BIOS setup utility, the main menu will appear on the screen. Use the arrows to highlight the item "BIOS FEATURES SETUP".

AMIBIOS SIMPLE SETUP UTILITY - VERSION 1.24b (C) 1999 American Megatrends, Inc. All Rights Reserved	
STANDARD CMOS SETUP BIOS FEATURES SETUP CHIPSET FEATURES SETUP POWER MANAGEMENT SETUP PNP / PCI CONFIGURATION LOAD BIOS DEFAULTS LOAD SETUP DEFAULTS	INTEGRATED PERIPHERALS HARDWARE MONITOR & MISC SETUP SUPERVISOR PASSWORD USER PASSWORD IDE HDD AUTO DETECTION SAVE & EXIT SETUP EXIT WITHOUT SAVING
ESC: Quit ↑↓←→ : Select Item (Shift)F2 : Change Color F5: Old Values F6: Load BIOS Defaults F7: Load Setup Defaults F10: Save & Exit	
Time, Date , Hard Disk Type...	

- (3) Press "Enter" to enter "BIOS FEATURES SETUP" menu. Use the arrows to highlight the item "1st Boot Device", and then use the "Page Up" or "Page Down" keys to select "Floppy".

AMIBIOS SETUP - BIOS FEATURES SETUP	
(C) 2001 American Megatrends, Inc. All Rights Reserved	
1st Boot Device : Floppy	
2nd Boot Device : IDE-0	
3rd Boot Device : CDROM	
S.M.A.R.T. for Hard Disks : Disabled	
BootUp Num-Lock : On	ESC: Quit ↑↓←→: Select Item
Floppy Drive Seek : Disabled	F1 : Help PU/PD/+/- : Modify
Password Check : Setup	F5 : Old Values (Shift)F2: Color
	F6 : Load BIOS Defaults
	F7 : Load Setup Defaults

- (4) Press "ESC" to go back to previous screen. Use the arrows to highlight the item "SAVE & EXIT SETUP" then press "Enter". System will ask "SAVE to CMOS and EXIT (Y/N)?" Press "Y" and "Enter" keys to confirm. Now the system will reboot automatically, the new BIOS setting will be taken effect next boot-up.

AMIBIOS SIMPLE SETUP UTILITY - VERSION 1.24b	
(C) 2001 American Megatrends, Inc. All Rights Reserved	
STANDARD CMOS SETUP	INTEGRATED PERIPHERALS
BIOS FEATURES SETUP	HARDWARE MONITOR & MISC SETUP
CHIPSET FEATURES SETUP	SUPERVISOR PASSWORD
POWER MANAGEMENT SETUP	USER PASSWORD
PNP / PCI CONF	Save to CMOS and EXIT (Y/N)? Y
LOAD BIOS DEFAULTS	SAVE & EXIT SETUP
LOAD SETUP DEFAULTS	EXIT WITHOUT SAVING
ESC: Quit ↑↓←→ : Select Item (Shift)F2 : Change Color F5: Old Values	
F6: Load BIOS Defaults F7: Load Setup Defaults F10: Save & Exit	
Save Data to CMOS & Exit SETUP	

STEP 5: BIOS flashing.

- (1) After the system boot from floppy disk, type "A:\> dir/w" and press "Enter" to check the entire files in floppy A. Then type the "BIOS flash utility" and "BIOS file" after A:\>. In this case you have to type "A:\> Flash841 7VTX.F4" and then press "Enter".

```
Starting Windows 98...

Microsoft(R) Windows98
  © Copyright Microsoft Corp 1981-1999

A:\> dir/w
  Volume in drive A has no label
  Volume Serial Number is 16EB-353D
  Directory of A:\
COMMAND.COM      7VTX.F4  FLASH841.EXE
      3 file(s)    838,954 bytes
      0 dir(s)    324,608 bytes free

A:\> Flash841 7VTX.F4
```

- (2) Now screen appears the following Flash Utility main menu. Press "Enter", the highlighted item will locate on the model name of the right-upper screen. Right after that, press "Enter" to start BIOS Flash Utility.

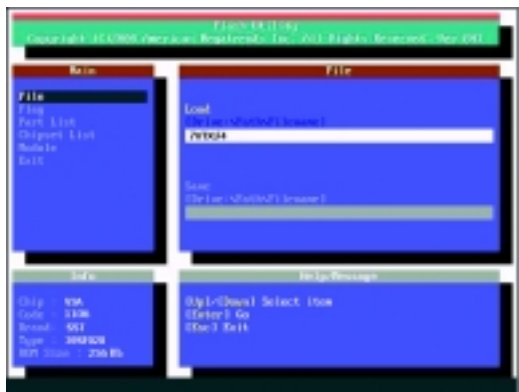

- (3) It will pop up a screen and asks "Are you sure to flash the BIOS?" Press [Enter] to continue the procedure, or press [ESC] to quit.

Beware: Please do not turn off the system while you are upgrading BIOS. It will render your BIOS corrupted and system totally inoperative.

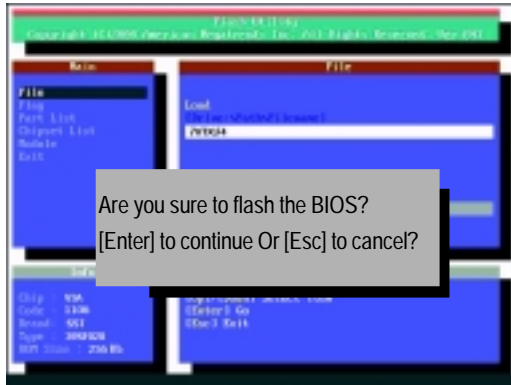

- (4) The BIOS flash completed. Please press [ESC] to exit Flash Utility.

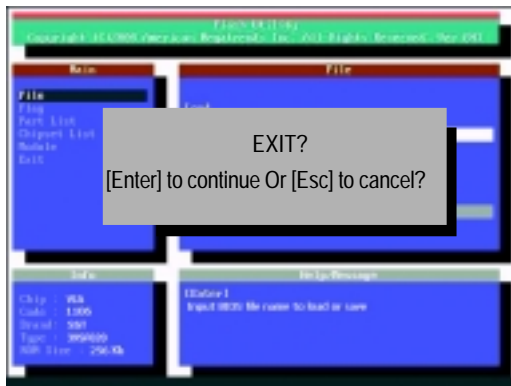

STEP 6: Load BIOS defaults.

Normally the system redetects all devices after BIOS has been upgraded. Therefore, we highly recommend reloading the BIOS defaults after BIOS has been upgraded. This important step resets everything after the flash.

- (1) Take out the floppy diskette from floppy drive, and then restart the system. The boot up screen will indicate your motherboard model and current BIOS version.



- (2) Don't forget to press key to enter BIOS setup again when system is boot up. Use the arrows to highlight the item "LOAD SETUP DEFAULTS" then press "Enter". System will ask "Load Setup Defaults (Y/N)?" Press "Y" and "Enter" keys to confirm.

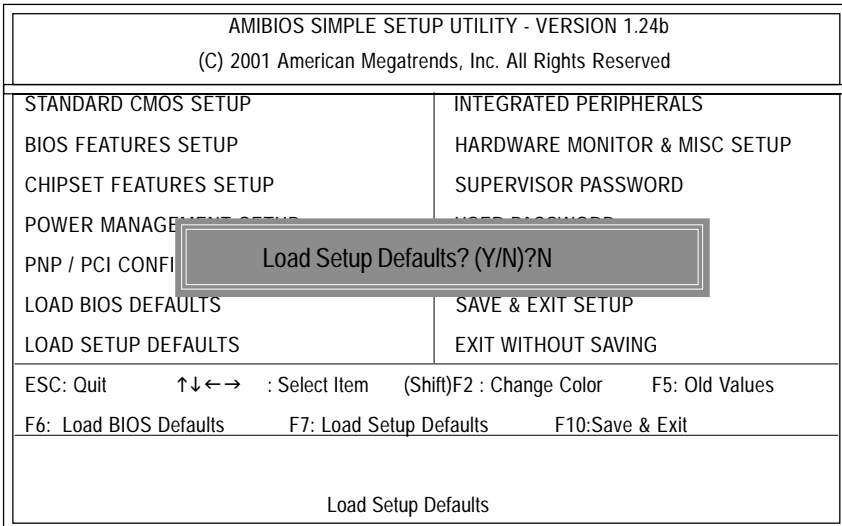

- (3) Use the arrows to highlight the item "SAVE & EXIT SETUP" and press "Enter". System will ask "SAVE to CMOS and EXIT (Y/N)?" Press "Y" and "Enter" keys to confirm. Now the system will reboot automatically, the new BIOS setting will be taken effect next boot-up.

AMBIOS SIMPLE SETUP UTILITY - VERSION 1.24b	
(C) 2001 American Megatrends, Inc. All Rights Reserved	
STANDARD CMOS SETUP	INTEGRATED PERIPHERALS
BIOS FEATURES SETUP	HARDWARE MONITOR & MISC SETUP
CHIPSET FEATURES SETUP	SUPERVISOR PASSWORD
POWER MANAGEMENT SETUP	USER PASSWORD
PNP / PCI CONF	SAVE & EXIT SETUP
LOAD BIOS DEFAULTS	EXIT WITHOUT SAVING
LOAD SETUP DEFAULTS	
ESC: Quit ↑↓←→ : Select Item (Shift)F2 : Change Color F5: Old Values	
F6: Load BIOS Defaults F7: Load Setup Defaults F10: Save & Exit	
Save Data to CMOS & Exit SETUP	

- (4) Congratulate you have accomplished the BIOS flash procedure.

Appendix F: Acronyms

Acronyms	Meaning
ACPI	Advanced Configuration and Power Interface
APM	Advanced Power Management
AGP	Accelerated Graphics Port
AMR	Audio Modem Riser
ACR	Advanced Communications Riser
BBS	BIOS Boot Specification
BIOS	Basic Input / Output System
CPU	Central Processing Unit
CMOS	Complementary Metal Oxide Semiconductor
CRIMM	Continuity RIMM
CNR	Communication and Networking Riser
DMA	Direct Memory Access
DMI	Desktop Management Interface
DIMM	Dual Inline Memory Module
DRM	Dual Retention Mechanism
DRAM	Dynamic Random Access Memory
DDR	Double Data Rate
ECP	Extended Capabilities Port
ESCD	Extended System Configuration Data
ECC	Error Checking and Correcting
EMC	Electromagnetic Compatibility
EPP	Enhanced Parallel Port
ESD	Electrostatic Discharge
FDD	Floppy Disk Device
FSB	Front Side Bus
HDD	Hard Disk Device
IDE	Integrated Dual Channel Enhanced
IRQ	Interrupt Request
I/O	Input / Output
IOAPIC	Input Output Advanced Programmable Input Controller
ISA	Industry Standard Architecture

to be continued.....

Acronyms	Meaning
LAN	Local Area Network
LBA	Logical Block Addressing
LED	Light Emitting Diode
MHz	Megahertz
MIDI	Musical Interface Digital Interface
MTH	Memory Translator Hub
MPT	Memory Protocol Translator
NIC	Network Interface Card
OS	Operating System
OEM	Original Equipment Manufacturer
PAC	PCI A.G.P. Controller
POST	Power-On Self Test
PCI	Peripheral Component Interconnect
RIMM	Rambus in-line Memory Module
SCI	Special Circumstance Instructions
SECC	Single Edge Contact Cartridge
SRAM	Static Random Access Memory
SMP	Symmetric Multi-Processing
SMI	System Management Interrupt
USB	Universal Serial Bus
VID	Voltage ID

Technical Support/RMA Sheet



Customer/Country:	Company:	Phone No.:
Contact Person:	E-mail Add. :	

Model name/Lot Number:	PCB revision:
BIOS version:	O.S./A.S.:

Hardware Configuration	Mfs.	Model name	Size:	Driver/Utility:
CPU				
Memory				
Brand				
Video Card				
Audio Card				
HDD				
CD-ROM / DVD-ROM				
Modem				
Network				
AMR / CNR				
Keyboard				
Mouse				
Power supply				
Other Device				

Problem Description:

